

Inch
Pouce



Thread Cutting / Tapping Screws - Indented Hex / Phillips Drive
 Vis autotaraudeuses taillant le filet/autotaraudeuses – tête hexagonale dentelée/cruciforme

Hardened
STEEL

“SEMS” TYPE TAPPING SCREWS



HEXAGON & PHILLIPS DRIVE

TYPES
A, B, 1, 23, 25

ILLUSTRATION	SPAENAUR No.	SIZE	DESCRIPTION	PKG QTY.
	464-109	#6 x 1/2" (1/4" AF)	Indented Hexagon Head, Steel, Zinc Plated Type 25 - with 1/4" O.D. External Tooth Lockwasher.	100
	460-B07-1N	8-32 x 1/2"	Phillips Truss Head, Steel, Zinc Plated Type 23 - with 3/8" O.D. External Tooth Lockwasher.	100
	2357	#8 x 7/16"	Phillips Round Washer Head, Steel, Nickel Plated Type A - with 3/8" O.D. External Tooth Lockwasher.	100
	SE-29 SE-30 SE-31 SE-32	#8 x 5/8" #8 x 3/4" #8 x 1" #8 x 1-1/4"	Phillips Oval Head, Steel, Nickel Plated Type A - with Nickel Plated Finishing Washer. Screws have No. 6 Head. Auto Trim TAPPING Screws	100 100 100 100
	ST-78H	#14A x 3/4"	Indented Hexagon Head (7/16" AF), Steel, Zinc Plated Type AB - with 5/8" O.D. x 3/64" Thick Flat Washer.	50
	464-A01-1X	5/16"-18 x 1-5/8" (1/2" AF)	Indented Hexagon Head, Steel, Cadmium Plated Type 23 - with 3/4" O.D. Flat Washer. Indented Hexagon Head, Steel, Zinc Plated	100
	460-B03-1A	5/16"-18 x 1/2" (1/2" AF)	Type 1 - with 9/16" O.D. External Tooth Lockwasher.	100

NEW

E-Z COIL

For E-Z Coil® Thread Repair Kit
See Page C191



STANDARD



ECONOMY

CATALOG 14 SPAENAUR

Machine Screws / Shoulder Bolts / Tapping Screws

Vis mécaniques / Vis à épaulement / Vis autotaraudeuses

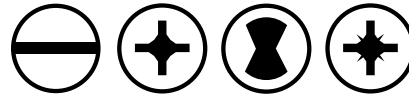

Inch
Pouce

B

STEEL Inch Sizes ASME B18.13	 SLOT	“SEMS” TYPE MACHINE SCREWS		 PHILLIPS
PLATING: Zinc or Cadmium at our option.				
ILLUSTRATION	SPAENAUR No.	SIZE	DESCRIPTION	PKG QTY.
	B-950	1/4"-20 UNC x 7/16"	Slot Binding Head, Steel, Plated, Sems Screw - with External Tooth Shakeproof Lockwasher.	100
	460-B01-1M	4-40 UNC x 1/4"	Phillips Pan Head, Steel, Plated, Sems Screw- with External Tooth Shakeproof Lockwasher.	100
	460-001	4-40 UNC x 1/2"		100
	460-B02-1X	6-32 UNC x 1/4"		100
	460-B04-1P	6-32 UNC x 3/8"		100
	SE-84P	10-24 UNC x 7/8"		100
	SE-26	10-32 UNF x 5/18"		100
	460-022	10-32 UNF x 1"		100
	460-B05-1Y	8-32 UNC x 3/8"	Phillips Pan Head, Steel, Nickel Plated, Sems Screw- with Internal Tooth Lockwasher.	100

STEEL	 PHILLIPS DRIVE (Cross Recess)			
ILLUSTRATION	SPAENAUR No.	SIZE	DESCRIPTION	PKG QTY.
	SE-50P	8-32 UNC x 1/2"	Phillips Binding Head, Zinc Plated Steel, Sems	100

STEEL	Inch Sizes *Type 23 Thread-Cutting.						
SPAENAUR No.	Screw Size	Head Style	Width Across Flat	Washer Type	Washer O.D.	Finish	PKG QTY.
SE-18-ZP	1/4"-20 x 5/8"	Indented Hex.	7/16"	Ext. Tooth	.480"	Zinc	50
*SE-77H	5/16"-18 x 1-5/8"	Indented Hex.	1/2"	Flat	3/4"	Zinc Chr.	100

<p> KNURLED HEAD MACHINE SCREWS Steel - Nickel Plated</p> <p style="text-align: center;">MS-443 8-32 x 1/2" Nic. Pltd</p> <p>PKG QTY. 100</p> <hr/> <p>Hardened Screw-in Stud. Stainless steel replaces weld on stud used for attaching moulding clips to body.</p> <p style="text-align: center;">599-015</p> <p style="text-align: center;">SIZE: #4B x 5/8"</p> <p style="text-align: center;"></p> <p>PKG QTY. 100</p>	<p style="text-align: center;"></p> <p style="text-align: center;">386-C01-1K 1/4"-20 x 1"</p> <p>Pozi-Drive Flat Ctsk. Steel Mach. Screw Zinc Di-chromate ASME B18.6.3</p> <p>PKG QTY. 100</p>	<p style="text-align: center;"></p> <p style="text-align: center;">535-005 10 x 1-1/4" Round Hd.</p> <p style="text-align: center;">“SCRULOX 8” Drive (use Robertson Square Soc. Driver)</p> <p style="text-align: center;">Type AB Tapping Screws Zinc Chromate Plated</p> <p>PKG QTY. 100</p>
--	--	---

SPAENAUR CATALOG 14

B118

Inch

Pouce

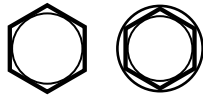

Automotive & Specialty Screws - Hex Drive

Vis spécialisées et pour automobile – prise hexagonale

STEEL

Hex Head

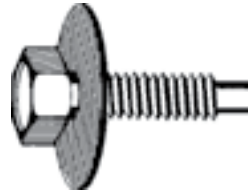

Dog Point

Ford Products '77/.

SPAENAUR No.	Screw Size	Hex Width	Washer O.D.	Finish	PKG QTY.
460-002	1/4"-20 x 3/4"	7/16"	3/4"	Phosphate and Oil	50
460-003	1/4"-20 x 15/16"	7/16"	3/4"	Black Phosphate	50
460-004	1/4"-20 x 15/16"	7/16"	3/4"	Dichromate	50
460-005	1/4"-20 x 1-1/8"	7/16"	3/4"	Dichromate	50
460-006	5/16"-18 x 15/16"	1/2"	7/8"	Dichromate	50
460-007	5/16"-18 x 15/16"	1/2"	7/8"	Phosphate and Oil	50
460-008	5/16"-18 x 1-1/16"	1/2"	7/8"	Dichromate	50
460-009	5/16"-18 x 1-3/16"	1/2"	7/8"	Dichromate	50
460-011	5/16"-18 x 1-3/16"	1/2"	7/8"	Phosphate and Oil	50
460-B06-1C	5/16"-18 x 1-7/16"	1/2"	7/8"	Dichromate	50
460-013	3/8"-16 x 1-3/16"	9/16"	1"	Phosphate and Oil	50

See Page B121 and B122 for Metric sizes.

**Automotive and Special Screws
Vis d'automobile et vis spéciales**

STEEL



MS-243



MS-241

INCH SIZES

SPAENAUR No.	Screw Size	Head Style, Etc.	Hex. Width	Head O.D.	Point Style	Finish
MS-243	5/16"-18 x 3/4"	Indented Hex. Washer "Spin-Lok"	1/2"	13/16"	Dog	Cadmium
MS-241	5/16"-24 x 1"	Indented Hex. Washer "Spin-Lok"	1/2"	13/16"	Dog	Parkerized

PKG QTY. 50

ASSORTMENT 805-513A

AUTOMOTIVE SPECIAL SCREWS & NUTS WITH TINNERMAN® FASTENERS

Panel Nuts & Automotive Screws
Steel

26 SIZES - 321 PIECES

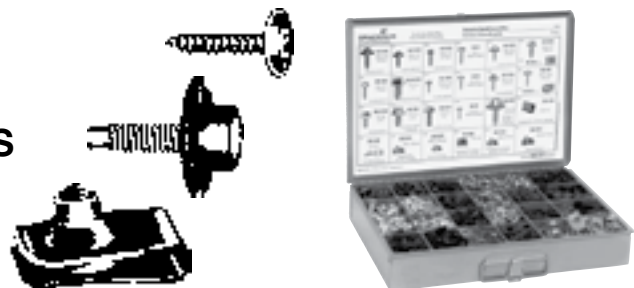

For the complete assortment contents turn to A43

CATALOG 14

SPAENAUR

Hex Flange Serrated Screws

Vis dentelées hexagonales à embase



Inch

Pouce

STEEL

Case-hardened to RC 40

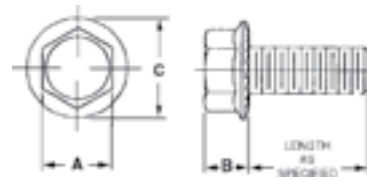

HEX FLANGE (Serrated) SCREW

Zinc Plated

B

Thread Size	SPAENAUR No.	Length Under Head	A Min. Width A/F	B Flange Head Thick.	C Flange Dia. Min.	PKG QTY.	Thread Size	SPAENAUR No.	Length Under Head	A Min. Width A/F	B Flange Head Thick.	C Flange Dia. Min.	PKG QTY.		
6-32 UNC	328-048	1/4"	.181"	.132"	.254"	100	1/4"-28 UNF	328-042	1/2"	.367"	.216"	.513"	100		
	328-049	3/8"				100		328-031	3/4"				100		
	328-001	1/2"				100		5/16"-18 UNC	328-034				7/8"	100	
	328-041	5/8"				100			328-035				1-1/2"	100	
	328-002	3/4"				100			3/8"-16 UNC				328-F05-1W	3/4"	50
	328-003	1"				100							328-F04-1K	1"	50
8-32 UNC	328-050	5/16"	.241"	.161"	.341"	100	328-F06-1M	1-1/4"		50					
	328-004	1/2"				100	328-F08-1A	1-1/2"		50					
	328-025	5/8"				100	7/16"-14 UNC	328-038		1-1/4"	.612"	.365"	.856"	50	
	328-005	3/4"				100									
328-006	1"	100													
10-24 UNC	328-008	3/4"	.305"	.185"	.425"	100	1/2"-13 UNC	328-045	3/4"	.736"	.430"	1.027"	25		
	328-027	1-1/4"				100		328-039	1"				25		
10-32 UNF	328-011	3/4"	.305"	.185"	.425"	100		328-046	1-1/4"				25		
	328-012	1"				100		328-040	1-1/2"				25		
	328-028	1-1/4"				100		328-047	2"				25		
1/4"-20 UNC	328-013	1/2"	.367"	.216"	.513"	100									
	328-029	5/8"				100									
	328-030	7/8"				100									

Advantages:

Fully Reusable

One Piece Construction — Eliminates lockwashers and multiple piece assemblies.

Flange Base — Distributes load over greater area, higher strength.

Excellent Locking Features — 30% more torque to remove than to apply.

Excellent Electrical Contact — Positive bearing surface to bearing surface contact.

Lower Cost than Preassembled Fasteners — 1. Increases product reliability.
2. Reduces assembly time.

See page C23 for
FLANGE WHIZ-LOCK NUTS

CATALOG 14

SPAENAUR

Metric

Métrique

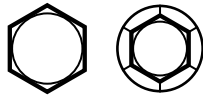

Automotive / Hex Flange Serrated Screws
 Vis dentelées pour automobile / hexagonales à embase

Hex Head Dog Point

STEEL

Ford Products '79/.



SPAENAUR No.	Screw Size	Hex Width	Washer O.D.	Finish	PKG QTY.
461-018	M6 x 1.00 x 18 mm	8 mm	19 mm	Zinc, Yellow Dichromate	50
461-019	M6 x 1.00 x 23 mm	8 mm	19 mm	Zinc, Yellow Dichromate	50

General Motors '77/'79

Substance & FINISH:
Usually to O.E.M. Specifications



▲ Regular Point



*with Starter Point

SPAENAUR No.	Screw Size	Hex Width	Washer O.D.	Finish	PKG QTY.
▲ 461-A01-1Y	M6 x 1.00 x 25 mm	10 mm	17 mm	Phosphate (Black)	25
▲ 461-004	M6.3 x 1.00 x 20 mm	10 mm	17 mm	Phosphate (Black)	25
*461-001	M6.3 x 1.00 x 20 mm	10 mm	20 mm	Phosphate (Blue)	25
*461-A02-1C	M6.3 x 1.00 x 25 mm	10 mm	23.8 mm	Phosphate (Black)	25
*461-005	M10 x 1.50 x 40 mm	15 mm	28.6 mm	Phosphate (Black)	25
466-001	M6.3 x 20 mm	10 mm	23.8 mm	Phosphate (Black)	25

Tensilok®

Hex Flange (serrated) Screws

Steel — Black Finish



One Piece Construction

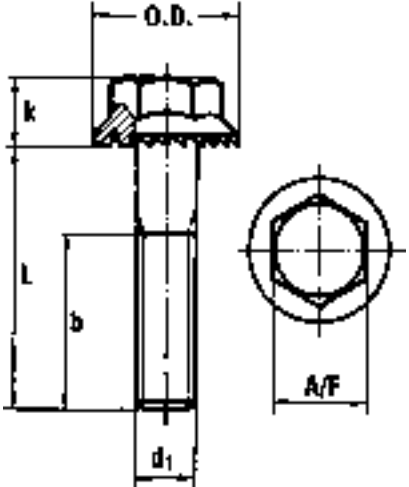

d1=Dia.	M5	M6	M8	M10	M12	M16
Pitch mm	0.8	1	1.25	1.5	1.75	2
b max.	16	18	22	26	30	38
O.D. max.	11.20	14.25	18.25	21	24	31
k max.	4.3	5.5	7	7.9	8.7	11.2
A/F	8	10	13	15	17	22
Lgth. mm	ORDER BY SPAENAUR NUMBERS LISTED BELOW					
8	328-210					
10	328-211	328-215				PKG QTY.
12	328-212	328-216	328-222			25
16	328-213	328-217	328-223	328-231		
18		328-218	328-224	328-232		
20	328-214	328-F16-1K	328-225	328-233	328-239	
22			328-226	328-234		
25		328-220	328-227	328-235	328-240	328-246
30		328-221	328-228	328-236	328-241	328-247
35			328-229	328-237	328-242	328-248
40			328-230	328-238	328-243	328-249
45					328-244	328-250
50					328-245	328-251
55						328-252
60						328-253
70						328-254

Tensile strength R_m: • for M5 - M10 dia. min. 900-1100 MPa (approx. 130500-159500 psi)
 • for M12 - M16 dia. min. 1000-1200 MPa (approx. 145000-174000 psi)

CATALOG 14 SPAENAUR

B

Automotive Screws / Machine Screws

Vis pour l'automobile / Vis mécaniques

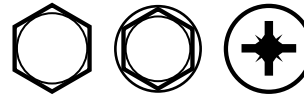

Metric
Métrique

B

STEEL

Substance and FINISH: Usually to O.E.M. Specifications



461-014

10 mm x 22 mm

(15 mm across flats)

Blue

Prop. Class 9.8

Indented Hex Head Bolt with
20 mm Washer.

General Motors '77/.

PKG QTY. 50



461-016

6.3 mm x 40 mm

(10 mm across flats)

Indented Hex Head Bolt with 17 mm
Washer.

General Motors '77/.

PKG QTY. 50



461-017

4 mm x 0.7 x 16 mm Black

(7 mm across flats)

Hex Head Screw with 12 mm Washer.

General Motors '77/.

PKG QTY. 100



542-004

M8 x 1.25 x 25 mm

Indented
Hex-Washer Head
(13 mm across flats)

Hardened - Machine Screw

Phosphate & Oil Finish

PKG QTY. 50

461-012
8 mm x 1.25 x 25 mm Grade 9.8
(13 mm across flats)

Indented Hex Head Bolt Type CA with
23 mm Conical Washer.

General Motors '77/.

PKG QTY. 50

461-015
10 mm x 40 mm
(15 mm across flats)

Screw Indented Hex Head with Loose
30 mm Washer, CA Point

General Motors Cars '76/.

PKG QTY. 50



389-001

M6 x 20 mm
(Pozidrive)

Screw, Rear License
Plate Attaching

Ford Fiesta 78/.

STEEL, Zinc Dichromate
Plated

PKG QTY. 50

814-026

**Dura-Hang™
Panel Hangers**

Made of Steel and
Nickel Plated these
hangers are ideal to
hang storage racks
814-043 and 814-044.



They are adjustable
to fit up to 3-3/8" wide panels.

PKG QTY. 1 Set

(Includes 2 hangers and a wrench)

814-043

**Storage Rack Holds
5 Regular Size
Plastic Compartment
Boxes**

This versatile cold rolled steel
rack with grey baked enamel
finish has been designed for
three way use. Keyhole slots
are furnished for wall mounting.
A handle is provided and bolt
holes permit stacking.





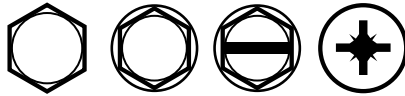



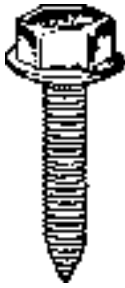

Inch and **Metric**
Pouce et **Métrique**

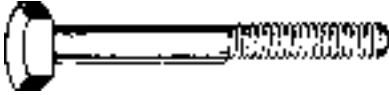

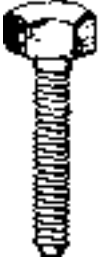
Automotive Screws

Vis pour l'automobile

 <p>392-014 M4 x 0.70 x 42 mm 6.3 mm (1/4") across flats Slotted Hex Washer Head Machine Screw Black Zinc Plated PKG QTY. 50</p>	 <p>Screw, Hex Washer Head General Motors '76/'79 392-004 Replaces 11503616 M6.3 x 25 mm 10 mm across flats PKG QTY. 50</p> <hr/> <p>392-002 (362029) M8 x 1.25 Pitch x 30 mm 13 mm across flats PKG QTY. 25</p>	<p>Substance and FINISH: Usually to OEM specifications</p>  <p>491-002 M4.2 x 12 mm (8-18 x 1/2") 6.3 mm (1/4") across flats Screw, Indented Hex Head, for use in Plastic Grills, etc. General purpose, all cars, trucks, etc. PKG QTY. 100</p>	
 <p>392-006 Replaces 11500039 M6 x 45 mm 10 mm across flats Hex Head Bolt, Metric General Motors '79/. PKG QTY. 50</p>	 <p>392-011 Replaces 11504499 M8 x 1.25 x 30 mm 13 mm across flats 16 mm washer hd. O.D. Bolt, Indented Hex Washer Head: General Motors '79/. PKG QTY. 50</p>	 <p>389-001 M6 x 20 mm (Pozi-Drive) Screw, Rear License Plate Attaching Ford Fiesta '78/. PKG QTY. 50</p>	
<p>392-008 Replaces 11500001 M6 x 20 mm 10 mm across flats Hex Head Bolt, Metric General Motors '79/. PKG QTY. 50</p> <p>392-007 Replaces 11504023 M6 x 65 mm 10 mm across flats Hex Head Bolt, Metric General Motors '79/. PKG QTY. 50</p> <p>392-009 Replaces 11503948 M6 x 25 mm 10 mm across flats Hex Head Bolt, Metric General Motors '79/. PKG QTY. 50</p> 	 <p>Metric Hex Flange Head Screw General Motors '77/'79. 392-001 (11504499) (11504501) M8 x 1.25 Pitch x 25 mm 13 mm across flats 15 mm washer hd. O.D. PKG QTY. 25</p>	 <p>389-002 Replaces 11502623 M4 x 0.7 x 20 mm Blue Metric, Philips Flat Head Machine Screw Pozi-Drive General Motors '77/. PKG QTY. 100</p>	 <p>496-001 Replaces 11501917 M7.9 x 1.59 x 20 mm 10 mm across flats Oldsmobile '77/. Hex, Washer Head Bolt, Hi-Lo Thread Grill and Fiberglass Front End Members. PKG QTY. 50</p>

ASSORTMENT
ASSORTIMENT 805-513A

26 SIZES — 321 PIECES

AUTOMOTIVE SPECIAL SCREWS & NUTS WITH TINNEMAN® FASTENERS

Panel Nuts & Automotive Screws
Steel

Furnished in Regular Size, Grey enamelled
STEEL Drawer with scooped bins. Drawer
will fit into Slide Racks shown on page A2

Size: 13-3/8" x 9-1/4" x 2"
Shipping Wt. **4.88 kg** (10-3/4 lbs.)



For the complete assortment contents turn to A43