

Threaded Insert Installation Tools

Outils d'installation pour inserts filetés

STANLEY
Engineered Fastening

HeliCoil

Inch and Metric
Pouce et Métrique



Heavy-duty Style

HeliCoil Installation Tools for hand installation of inserts.

Note: HeliCoil Installation Tools vary in design and appearance, ranging from light-weight to heavy-duty styles as thread size increases.

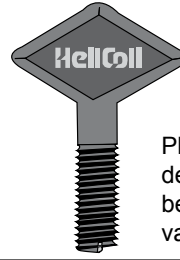

ECONOMY STYLE

HeliCoil Installation Tools for hand installation of inserts.

Plastic Installation Tools, as illustrated, are designated by a square (■). The other numbers listed are STEEL with a black finish, and vary in design and appearance.

Inch Sizes			Metric Sizes			Inch Sizes			Metric Sizes		
THREAD Size	SPAENAUR No.	HeliCoil No.	THREAD Size	SPAENAUR No.	HeliCoil No.	THREAD Size	SPAENAUR No.	HeliCoil No.	Size	SPAENAUR No.	HeliCoil No.
2-56	876-650	551-02	M2.2 x 0.45	877-042	7751-2.2	6-32	876-654	2288-06	M5 x 0.8	877-000	3747-5
3-48	876-651	551-03	M2.5 x 0.45	877-043	7751-2.5	8-32	876-046	2288-2	M6 x 1.0	877-001	3747-6
3-56	876-655	7552-03	M3 x 0.50	877-044	7751-3	10-24	876-030	2288-3	M6.3 x 1.0	877-002	3747-6.3
4-40	876-652	7551-04	M3.5 x 0.60	877-045	7751-3.5	10-32	876-070	2299-3	M7 x 1.0	877-003	3747-7
4-48	876-656	7552-04	M4 x 0.7	877-021	7751-4	12-24	876-031	2288-1	M8 x 1.25	877-004	3747-8
5-40	876-653	7551-05	M5 x 0.8	877-047	7751-5	1/4"-20	876-683	2288-4	M8 x 1.00	877-011	4835-8
6-32	876-659	7551-06	M6 x 1.0	877-048	7751-6	1/4"-20	■ 876-032	5288-4	M10 x 1.50	877-005	3747-10
6-40	876-657	7552-06	M7 x 1.0	877-049	7751-7	1/4"-28	876-071	2299-4	M10 x 1.25	877-012	4640-10-1
8-32	876-660	7551-2	M8 x 1.25	877-050	7751-8	5/16"-18	876-684	2288-5	M11 x 1.00	877-013	4835-11
8-36	876-658	7552-2	M8 x 1.0	877-051	7755-8	5/16"-18	■ 876-033	5288-5	M11 x 1.50	877-041	3747-11-5
10-24	876-661	7551-3	M10 x 1.5	877-052	7751-10	5/16"-24	876-072	2299-5	M12 x 1.75	877-006	3747-12
10-32	876-662	7552-3	M10 x 1.0	877-053	7755-10	3/8"-16	876-685	2288-6	M12 x 1.50	877-014	4973-12
12-24	876-663	7551-1	M10 x 1.25	877-054	7756-10				M14 x 2.00	877-007	3747-14
1/4"-20	876-664	7551-4	M12 x 1.75	877-055	7751-12	3/8"-24	876-073	2299-6	M14 x 1.50	877-015	4973-14
1/4"-28	876-665	7552-4	M12 x 1.50	877-056	7753-12	7/16"-14	876-686	2288-7	M16 x 2.00	877-008	3747-16
5/16"-18	876-666	7551-5	M12 x 1.25	877-046	7756-12	7/16"-14	■ 876-035	5288-7	M16 x 1.50	877-016	4973-16
5/16"-24	876-667	7552-5	M14 x 2.0	877-057	7751-14	7/16"-20	876-074	2299-7	M18 x 2.50	877-009	3747-18
3/8"-16	876-668	7551-6	M14 x 1.50	877-058	7753-14	1/2"-13	876-687	2288-8	M20 x 2.50	877-010	3747-20
3/8"-24	876-669	7552-6	M16 x 2.0	877-059	7751-16	1/2"-13	■ 876-036	5288-8			
7/16"-14	876-670	7551-7	M16 x 1.5	877-060	7753-16	1/2"-20	876-075	2299-8			
7/16"-20	876-671	7552-7	M18 x 2.5	877-061	7751-18	9/16"-18	876-076	2299-9			
1/2"-13	876-672	7551-8	M18 x 1.5	877-062	7753-18	5/8"-11	876-723	2288-10			
1/2"-20	876-673	7552-8	M20 x 2.5	877-063	7751-20	5/8"-11	■ 876-038	5288-10			
9/16"-12	876-037	3724-9				5/8"-18	876-077	2299-10			
9/16"-18	876-674	535-9				3/4"-10	876-724	2288-12			
5/8"-11	876-675	3724-10				3/4"-16	876-078	2299-12			
5/8"-18	876-676	535-10									

For Extracting Tools See Page C216

TANG BREAK-OFF TOOLS



Tang Break-off Tools are available for use with inserts up through 1/2" (M12) nominal diameter.

Their operation is automatic, having a spring loaded, easily triggered punch that strikes a sharp, uniform blow against the tang of the installed insert. It can be operated with one hand.

See page C216 for Extracting Tools.

Inch Sizes

THREAD Size	SPAENAUR No.	HeliCoil No.
#2/3 UNC & UNF	876-745	3695-02
#4/5 UNC & UNF	876-746	3695-04
#6 UNC & UNF	876-727	3695-06
#8 UNC & UNF	876-728	3695-2
#10 UNC & UNF	876-729	3695-3
1/4" UNC & UNF	876-730	3695-4
5/16"-18 UNC	876-1192	3695-5
5/16"-24 UNF	876-1193	3692-5
3/8"-16 UNC	876-743	3695-6
3/8"-24 UNF	876-1194	3692-6
7/16"-14 UNC	876-1195	3695-7
7/16"-20 UNF	876-1196	3692-7
1/2"-13 UNC	876-744	3695-8
1/2"-20 UNF	876-1197	3692-8

Metric Sizes

THREAD Size (Standard Coarse and Fine Thread)	SPAENAUR No.	HeliCoil No.
M2.2 & M2.5	877-066	4238-2.2
M3 & M3.5	877-067	4238-3
M4	877-068	4238-4
M5	877-069	4238-5
M6	877-070	4238-6
M8	877-071	4238-8
M10	877-072	4238-10
M12	877-073	4238-12

All tools this page -
PKG QTY. 1

Inch
Pouce

STANLEY **HeliCoil**
Engineered Fastening

Thread Repair Inserts / Taps / Installation Tools
Inserts pour réparation de filets / Tarauds / Outils d'installation

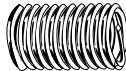
INCH Coarse Series (U.N.C.)		INDUSTRIAL Screw Thread Inserts				Standard Free-Running Style					
All TAPS and TOOLS - PKG QTY.1											
U.N.C. COARSE Thread Size	Insert LENGTH in Inches	DRILL For... Aluminum	SIZES Steel Magnesium & Plastic	HeliCoil Insert Stainless (304) Steel SPAENAUR No.	PKG QTY. Inserts only	Straight Flute for ALUMINUM Finishing		TAPS Class 3B for STEEL (mild) Finishing		HeliCoil HAND TOOL SPAENAUR No.	
						PLUG	BOTTOM	PLUG	BOTTOM		
2-56	.086	3/32 HSD-3/32	.096 (#41) HSD-41	627-050	25	874-030	874-035	874-030	874-035	876-650 HD	
	.129			627-051							
	.172			627-052							
	.258			627-054							
3-48	.099	.1065 (#36) HSD-36	.1094 (7/64) HSD-7/64	627-055	25	874-031	874-036	874-031	874-036	876-651 HD	
	.148			627-056							
	.198			627-057							
	.248			627-058							
	.297			627-059							
4-40	.112	.1200 (#31) HSD-31	.1200 (#31) HSD-31	627-060	25	874-032	874-037	874-032	874-037	876-652 HD	
	.168			627-061							
	.224			627-062							
	.280			627-C01-1M							
	.336			627-064							
5-40	.125	.1339 (3.4 mm) 875-573	.1360 (#29) HSD-29	627-065	25	874-033	874-038	874-033	874-038	876-653 HD	
	.188			627-066							
	.250			627-067							
	.312			627-068							
	.375			627-069							
6-32	.138	.1470 (#26) HSD-26	.1495 (#25) HSD-25	627-070	25	874-034	874-039	874-034	874-039	876-654 E	
	.207			627-071							
	.276			627-072							
	.345			627-073							
	.414			627-074							
8-32	.164	.1730 (#17) HSD-17	.1770 (#16) HSD-16	627-C02-1X	12	874-010	874-040	874-010	874-040	876-046 E	
	.246			627-850							
	.328			627-076							
	.410			627-077							
	.492			627-078							
10-24	.190	.2031 (13/64) HSD-13/64	.2055 (#5) HSD-5	627-079	12	874-011	874-041	874-011	874-041	876-030 E	
	.285			627-851							
	.380			627-080							
	.475			627-081							
	.570			627-082							
12-24	.216	.2280 (#1) HSD-1	.2280 (#1) HSD-1	627-083	12	874-012	874-042	874-012	874-042	876-031 E	
	.324			627-852							
	.432			627-084							
	.540			627-085							
	.648			627-086							
1/4"-20	.250	.2660 (#H) 875-181	.2660 (#H) 875-181	627-087	12	874-013	874-043	874-013	874-043	876-032 E	
	.375			627-853							
	.500			627-B92-1K							
	.625			627-089							
	.750			627-090							
5/16"-18	.312	.3320 (#Q) 875-179	.3320 (#Q) 875-179	627-091	12	874-014	874-044	874-014	874-044	876-033 E	
	.469			627-854							
	.625			627-092							
	.781			627-093							
	.938			627-094							
3/8"-16	.375	.3970 (#X) 875-182	.3970 (#X) 875-182	627-095	12	874-015	874-045	874-015	874-045	E	
	.562			627-855							
	.750			627-096							
	.938			627-097							
	1.125			627-098							
7/16"-14	.438	.4531 (29/64) HSD-29/64	.4531 (29/64) HSD-29/64	627-099	10	874-016	874-046	874-016	874-046	876-035 E	
	.656			627-856							
	.875			627-100							
	1.094			627-101							
	1.312										

Continued

See pages P25-P41 for Inch & Metric Drill listings

E = Economy Style
HD = Heavy Duty

© 2018 Spenaaur Inc. All rights reserved. Catalog may not be reproduced, in whole or in part, without the written permission of Spenaaur Inc. Subject to Catalog Terms and Conditions of Use available at Spenaaur.com and on page TC2 and TC3 at the back of this catalog.
© 2018 Spenaaur Inc. Tous droits réservés. Le catalogue ne peut être reproduit, en tout ou en partie, sans l'autorisation écrite de Spenaaur Inc. L'utilisation est soumise aux Conditions d'utilisation du Catalogue disponibles sur Spenaaur.com et à la page TC4 et TC5 à la fin de ce catalogue.

C209

CATALOG 14

SPAENAUR

Thread Repair Inserts / Taps / Installation Tools

STANLEY
Engineered Fastening

HeliCoil

Inch

Inserts pour réparation de filets / Tarauds / Outils d'installation

Pouce

INCH Coarse Series (U.N.C.)		INDUSTRIAL Screw Thread Inserts Standard Free-Running Style				All TAPS and TOOLS - PKG QTY. 1				
U.N.C. COARSE Thread Size	Insert LENGTH in Inches	DRILL SIZES		HeliCoil Insert Stainless (304) Steel SPAENAUR No.	PKG QTY. Inserts only	Straight Flute for ALUMINUM		TAPS Class 3B for STEEL (mild)		HeliCoil HAND TOOL SPAENAUR No.
		For... Aluminum	Steel Magnesium & Plastic			Finishing PLUG	Finishing BOTTOM	Finishing PLUG	Finishing BOTTOM	
1/2"-13	.500	.5156 (33/64)	.5312 (17/32)	627-103	10	874-017	874-182	874-017	874-182	876-036
	.750			627-857						
	1.000			627-B88-1C						
	1.250			627-105						
	1.500			627-106						
9/16"-12	.562	.5781 (37/64)	.5938 (19/32)	627-107	10	874-018	874-183	874-018	874-183	876-037
	.844			627-858						
	1.125			627-108						
	1.406			627-109						
	1.688			627-110						
5/8"-11	.625	.6562 (21/32)	.6562 (21/32)	627-111	10	874-019	874-184	874-019	874-184	876-038
	.938			627-859						
	1.250			627-112						
	1.562			627-113						
	1.875			627-114						
3/4"-10	.750	.7812 (25/32)	.7812 (25/32)	627-115	10	874-020	874-266	874-020	874-266	876-039
	1.125			627-860						
	1.500			627-116						
	1.875			627-117						
	2.250			627-118						
7/8"-9	.875	.9062 (29/32)	.9062 (29/32)	627-119	10	874-021	874-267	874-021	874-267	876-040
	1.312			627-861						
	1.750			627-120						
	2.188			627-121						
	2.625			627-122						
1"-8	1.000	1.0312 (1-1/32)	1.0312 (1-1/32)	627-123	10	874-022	874-268	874-022	874-268	876-041
	1.500			627-862						
	2.000			627-124						
	2.500			627-125						
	3.000			627-126						
1-1/8"-7	1.125	1.1719 (1-11/64)	1.1719 (1-11/64)	627-127	5	874-023	874-269	874-023	874-269	876-042
	1.688			627-863						
	2.250			627-128						
	2.812			627-129						
	3.375			627-130						
1-1/4"-7	1.250	1.2969 (1-19/64)	1.2969 (1-19/64)	627-131	5	874-024	874-270	874-024	874-270	876-043
	1.875			627-864						
	2.500			627-132						
	3.125			627-133						
	3.750			627-134						
1-3/8"-6	1.375	1.4219 (1-27/64)	1.4219 (1-27/64)	627-135	5	874-025	874-271	874-025	874-271	876-044
	2.062			627-865						
	2.750			627-136						
	3.438			627-137						
	4.125			627-138						
1-1/2"-6	1.500	1.5469 (1-35/64)	1.5469 (1-35/64)	627-139	5	874-026	874-272	874-026	874-272	876-045
	2.250			627-866						
	3.000			627-140						
	3.750			627-141						
	4.500			627-142						

HeliCoil ASSORTMENT 805-545
ASSORTIMENT

**INCH COARSE (U.N.C.) AND FINE (U.N.F)
REPAIR INSERT ASSORTMENT
24 SIZES - 190 PIECES**

4 U.N.C. Sizes — 87 Inserts.
(2-56, 4-40, 6-32 and 8-32)

4 U.N.F. Sizes— 87 Inserts.
(3-56, 4-48, 6-40 and 8-36)

Plus 8 Taps and 8 Installation Tools.

Furnished in REGULAR SIZE Steel drawer. Drawer will fit into Slide Racks shown on page A2.
Shipping Weight: **2.5 kg** (5.52 lbs)



Page **A70**

CATALOG 14

SPAENAUR

Inch
Pouce

STANLEY
Engineered Fastening

Helicoil

Drill Bits / Thread Repair Inserts / Taps / Tools

Inserts pour réparation de filets/Mèches/Tarands/Outils d'installation

INCH Fine Series (U.N.F.)		INDUSTRIAL Screw Thread Inserts Standard Free-Running Style				All TAP and TOOLS, PKG QTY. 1				
UNF FINE Thread Size	Insert LENGTH in Inches	DRILL SIZES For...		Helicoil Insert Stainless (304) Steel SPAENAUR No.	PKG QTY. Inserts only	Straight Flute TAPS Class 3B For ALUMINUM Finishing		For STEEL (Mild) Finishing		Helicoil HAND TOOL SPAENAUR No.
		Aluminum	Steel Magnesium & Plastic			PLUG	BOTTOM	PLUG	BOTTOM	
3-56	.099	.1040 (#37) HSD-37	.1065 (#36) HSD-36	627-149 627-150 627-151 627-153	25	874-196		874-196		876-656 HD
	.148									
	.198									
	.297									
4-48	.112	.1181 (3 mm) 875-568	.1200 (#31) HSD-31	627-154 627-155 627-156 627-157 627-158	25	874-197	874-1664	874-197	874-1664	876-656 HD
	.168									
	.224									
	.280									
	.336									
6-40	.138	.1470 (#26) HSD-26	.1495 (#25) HSD-25	627-159 627-160 627-161 627-162 627-163	25	874-198		874-198		876-657 HD
	.207									
	.276									
	.345									
	.414									
8-36	.164	.1730 (#17) HSD-17	.1770 (#16) HSD-16	627-164 627-165 627-166 627-167 627-168	12	874-199		874-199		876-658 HD
	.246									
	.328									
	.410									
	.492									
10-32	.190	.2010 (#7) HSD-7	.2031 (13/64") HSD-13/64	627-169 627-867 627-170 627-171 627-172	12	874-070	874-253	874-070	874-253	876-070 E
	.285									
	.380									
	.475									
	.570									
1/4"-28	.250	.2610 (G) 875-178	.2638 (6.7 mm) 875-612	627-173 627-868 627-B95-1X 627-175 627-176	12	874-071	874-1665	874-071	874-1665	876-071 E
	.375									
	.500									
	.625									
	.750									
5/16"-24	.312	.3281 (21/64") HSD-21/64	.3281 (21/64") HSD-21/64	627-177 627-869 627-178 627-179 627-180	12	874-072	874-254	874-072	874-254	876-072 E
	.469									
	.625									
	.781									
	.938									
3/8"-24	.375	.3906 (25/64") HSD-25/64	.3906 (25/64") HSD-25/64	627-181 627-870 627-182 627-184	12	874-073	874-258	874-073	874-258	876-073 E
	.562									
	.750									
	1.125									
7/16"-20	.438	.4531 (29/64") HSD-29/64	.4531 (29/64") HSD-29/64	627-185 627-871 627-186 627-187 627-188	10	874-074	874-255	874-074	874-255	876-074 E
	.656									
	.875									
	1.094									
	1.312									
1/2"-20	.500	.5156 (33/64") HSD-33/64	.5156 (33/64") HSD-33/64	627-189 627-872 627-190 627-191 627-192	10	874-075		874-075		876-075 E
	.750									
	1.000									
	1.250									
	1.500									
9/16"-18	.562	.5781 (37/64") HSD-37/64	.5781 (37/64") HSD-37/64	627-193 627-873 627-194 627-195 627-196	10	874-076		874-076		876-076 E
	.844									
	1.125									
	1.406									
	1.688									
5/8"-18	.625	.6406 (41/64") HSD-41/64	.6406 (41/64") HSD-41/64	627-197 627-874 627-B99-1C 627-199	10	874-077	874-256	874-077	874-256	876-077 E
	.938									
	1.250									
	1.562									
	1.875									

Continued

See pages P25-P30, P33-P41
for Inch & Metric Drill Listings

E = Economy Style
HD = Heavy Duty

© 2018 Spenaaur Inc. All rights reserved. Catalog may not be reproduced, in whole or in part, without the written permission of Spenaaur Inc. Subject to Catalog Terms and Conditions of Use available at Spenaaur.com and on page TC2 and TC3 at the back of this catalog.
© 2018 Spenaaur Inc. Tous droits réservés. Le catalogue ne peut être reproduit, en tout ou en partie, sans l'autorisation écrite de Spenaaur Inc. L'utilisation est soumise aux Conditions d'utilisation du Catalogue disponibles sur Spenaaur.com et à la page TC4 et TC5 à la fin de ce catalogue.

C211

CATALOG 14

SPAENAUR

Taps / Thread Repair Inserts

Inserts pour réparation de filets/Mèches/Tarauds/Outils d'installation

STANLEY
Engineered Fastening

HeliCoil

Inch
Pouce

INCH INDUSTRIAL Screw Thread Inserts Fine Series Standard Free-Running Style (U.N.F.)

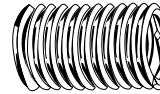

All TAPS and TOOLS - PKG QTY. 1

U.N.F. FINE Thread Size	Insert LENGTH in Inches	DRILL SIZES For...		HeliCoil Insert Stainless (304) Steel SPAENAUR No.	PKG QTY. Inserts only	Straight Flute TAPS For ALUMINUM Finishing		Class 3B TAPS For STEEL (Mild) Finishing		HeliCoil HAND TOOL SPAENAUR No.
		Aluminum	Steel Magnesium & Plastic			PLUG	BOTTOM	PLUG	BOTTOM	
3/4"-16	.750	.7656 (49/64")	.7656 (49/64")	627-220	10	874-078		874-078		876-078
	1.125			627-875						
	1.500			627-221						
	1.875			627-222						
	2.250			627-223						
7/8"-14	.875	.8906 (57/64")	.8906 (57/64")	627-224	10	874-079		874-079		876-079
	1.312			627-876						
	1.750			627-225						
	2.188			627-226						
	2.625			627-227						
1"-14	1.000	1.0156 (1-1/64")	1.0312 (1-1/32")	627-228	5	874-080	874-265	874-080	874-265	876-080
	1.500			627-877						
	2.000			627-229						
	2.500			627-230						
	3.000			627-231						
1"-12	1.000	1.0156 (1-1/64")	1.0312 (1-1/32")	627-232	5	874-081		874-081		876-081
	1.500			627-878						
	2.000			627-233						
	2.500			627-234						
	3.000			627-235						
1-1/8"-12	1.125	1.1406 (1-9/64")	1.11562 (1-5/32")	627-236	5	874-082		874-082		876-082
	1.688			627-879						
	2.250			627-237						
	2.812			627-238						
1-1/4"-12	1.250	1.2656 (1-17/64")	1.2812 (1-9/32")	627-240	5	874-083		874-083		876-083
	1.875			627-880						
	2.500			627-241						
	3.750			627-243						
1-3/8"-12	1.375	1.3906 (1-25/64")	1.4062 (1-13/32")	627-244	5	874-084		874-084		876-084
	2.062			627-881						
	2.750			627-245						
	3.438			627-246						
1-1/2"-12	1.500	1.5156 (1-33/64")	1.5312 (1-17/32")	627-248	5	874-085		874-085		876-085
	2.250			627-882						
	3.000			627-B96-1A						
	3.750			627-250						
	4.500									

HeliCoil ASSORTMENT ASSORTIMENT 805-463A

Inch Coarse (U.N.C.)
24 sizes - 104 only HeliCoil Inserts
Shipping Weight **3.18 kg** (7 lbs.)

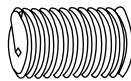

HeliCoil ASSORTMENT ASSORTIMENT 805-464

Inch Fine (U.N.F.)
304 Stainless Steel
24 sizes - 104 only HeliCoil Inserts
Shipping Weight **3.5 kg** (7.75 lbs.)

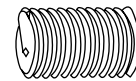

Regular Size Drawer: 13-3/8" x 9-1/4" x 2". Grey Enamelled Drawer fits the Slide Racks shown on page A2
Inside lid label shows Part Nos. for ordering refills, installation instructions, etc.



For the complete assortment contents turn to A70

Metric
Métrique

STANLEY **Helicoil**
Engineered Fastening

Drill Bits / Thread Repair Inserts / Taps / Tools

Inserts pour réparation de filets / Mèches / Tarauds / Outils d'installation

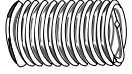
METRIC Standard COARSE THREAD		Industrial Screw Thread Inserts Standard Free-running Style				 All TAPS, TOOLS, PKG QTY. 1				
Metric COARSE Thread Size	Insert LENGTH in mm	DRILL SIZES		Helicoil Insert Stainless (304) Steel SPAENAUR No.	PKG QTY.	Straight Flute TAPS Class 5H For ALUMINUM		For STEEL (Mild)		Helicoil HAND TOOL SPAENAUR No.
		For... ALUM.	Magnesium, Plastic STEEL			Finishing PLUG	Finishing BOTTOM	Finishing PLUG	Finishing BOTTOM	
M2.2 Pitch: 0.45 mm	2.2			627-251	25	874-059		874-059		877-042 HD
	3.3			627-252						
	4.4	2.30	2.35	627-253						
	5.5			627-254						
	6.6	875-554	875-555							
M2.5 Pitch: 0.45 mm	2.5			627-255	25	874-061	874-578	874-061	874-578	877-043 HD
	3.8			627-256						
	5.0	2.55	2.65	627-B90-1N						
	6.3			627-258						
	7.5	875-559	875-561	627-259						
M3 Pitch: 0.50 mm	3.0			627-260	25	874-063	874-579	874-063	874-579	877-044 HD
	4.5			627-261						
	6.0	3.15	3.20	627-262						
	7.5			627-263						
	9.0	875-689	875-570	627-264						
M3.5 Pitch: 0.60 mm	3.5			627-265	25	874-065	874-580	874-065	874-580	877-045 HD
	5.3			627-266						
	7.0	3.70	3.70	627-267						
	10.5	875-576	875-576							
M4 Pitch: 0.70 mm	4.0			627-270	12	874-519	874-581	874-519	874-581	877-021 HD
	6.0			627-919						
	8.0	4.20	4.25	627-271						
	10.0			627-272						
	12.0	875-582	875-583	627-273						
M5 Pitch: 0.80 mm	5.0			627-274	12	874-520	874-582	874-520	874-582	877-000 E
	7.5			627-920						
	10.0	5.20	5.30	627-275						
	12.5			627-276						
	15.0	875-594	875-596	627-277						
M6 Pitch: 1.00 mm	6.0			627-278	12	874-521	874-583	874-521	874-583	877-001 E
	9.0			627-B98-1Y						
	12.0	6.25	6.30	627-279						
	15.0			627-280						
	18.0	875-607	875-608	627-281						
M6.3 Pitch: 1.00 mm	9.45	6.60	6.60		12	874-522		874-522		877-002 E
M7 Pitch: 1.00 mm	7.0			627-286	12	874-523		874-523		877-003 E
	10.5			627-923						
	14.0	7.25	7.30	627-287						
	17.5			627-288						
	21.0	875-619	875-620	627-289						
M8 Pitch: 1.25 mm	8.0			627-290	12	874-524	874-584	874-524	874-584	877-004 E
	12.0			627-924						
	16.0	8.30	8.40	627-B94-1M						
	20.0			627-292						
	24.0	875-632	875-633	627-293						
M10 Pitch: 1.50 mm	10.0			627-294	12	874-525	874-585	874-525	874-585	877-005 E
	15.0			627-925						
	20.0	10.50	10.50	627-295						
	25.0			627-296						
	30.0	875-658	875-658	627-297						
M12 Pitch: 1.75 mm	12.0			627-298	10	874-526	874-586	874-526	874-586	877-006 E
	18.0			627-926						
	24.0	12.50	12.50	627-299						
	30.0			627-300						
	36.0	875-682	875-682							

Continued

See pages P25-P30, P33-P41
for Inch & Metric Drill Listings

E = Economy Style
HD = Heavy Duty

© 2018 Spenaaur Inc. All rights reserved. Catalog may not be reproduced, in whole or in part, without the written permission of Spenaaur Inc. Subject to Catalog Terms and Conditions of Use available at Spenaaur.com and on page TC2 and TC3 at the back of this catalog.
© 2018 Spenaaur Inc. Tous droits réservés. Le catalogue ne peut être reproduit, en tout ou en partie, sans l'autorisation écrite de Spenaaur Inc. L'utilisation est soumise aux Conditions d'utilisation du Catalogue disponibles sur Spenaaur.com et à la page TC4 et TC5 à la fin de ce catalogue.

C213

CATALOG 14

SPAENAUR

Drill Bits / Thread Repair Inserts / Taps / Tools

STANLEY
Engineered Fastening

HeliCoil

Inch and **Metric**
Pouce et **Métrique**

Inserts pour réparation de filets / Tarauds / Outils d'installation

METRIC

Industrial Screw Thread Inserts



Standard

Standard Free-running Style

COARSE THREAD

See pages P25-P41 for Drill Listings.

All TAPS, TOOLS, PKG QTY. 1

Metric COARSE Thread Size	Insert LENGTH in mm	DRILL SIZES (mm)		HeliCoil Insert Stainless (304) Steel SPAENAUR No.	PKG QTY. Inserts only	Straight Flute TAPS Class 5H		HeliCoil HAND TOOL SPAENAUR No.
		For... ALUM.	Magnesium, Plastic STEEL			For ALUMINUM Finishing PLUG	For STEEL (Mild) Finishing PLUG	
M14 Pitch: 2.00 mm	14.0			627-301	10	874-527	874-527	877-007 E
	21.0			627-927				
	28.0	14.50	14.50	627-302				
	35.0			627-303				
	42.0	875-701	875-701	627-304				
M16 Pitch: 2.00 mm	16.0			627-305	10	874-528	874-528	877-008 E
	24.0			627-928				
	32.0	16.50	16.50	627-306				
	40.0			627-307				
	48.0	875-703	875-703	627-308				
M18 Pitch: 2.50 mm	18.0			627-309	10	874-529	874-529	877-009 E
	27.0			627-929				
	36.0	18.75	18.75	627-310				
	45.0			627-311				
	54.0			627-312				
M20 Pitch: 2.50 mm	20.0			627-313	10	874-530	874-530	877-010 E
	30.0			627-930				
	40.0	20.75	20.75	627-314				
	50.0			627-315				
	60.0			627-316				

Spark Plug Series (Metric & Inch)

E = Economy Style
HD = Heavy Duty

Thread Size	Reach	Tap SPAENAUR No.	Tool SPAENAUR No.	HeliCoil Inserts SPAENAUR No.	PKG QTY. Inserts Only
M10-1.0 mm	1/2"	874-531	877-017	627-938	6
M12-1.25 mm	1/2"	874-532	877-018	627-939	6
	3/4"			627-940	6
M14-1.25 mm	3/8"	874-533	877-019	627-941	6
	7/16"			627-942	6
	1/2"			627-943	6
	3/4"			627-944	6
M14-1.25 mm	.472"	874-533	877-019	627-945	6
M18-1.50 mm	1/2"	874-536	877-020	627-946	6
7/8"-18	1/2"-5/8"	874-086	876-086	627-883	6



HeliCoil

ASSORTMENT 805-465

METRIC COARSE AND FINE

304 Stainless Steel

Contains: 108 Pieces - 22 Sizes (M5 to M12 sizes) Plus 7 Taps and 7 Installation Tools. Complete with installation instructions

Shipping Weight **2.6 kg** (5.75 lbs.)



For the complete assortment contents turn to A71

Metric
Métrique

STANLEY
Engineered Fastening

HeliCoil

Drill Bits / Thread Repair Inserts / Taps / Tools

Inserts pour réparation de filets / Mèches / Tarauds / Outils d'installation

METRIC
FINE THREAD

Industrial Screw Thread Inserts

Standard Free-running Style

All TAPS, TOOLS - PKG QTY. 1

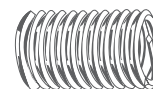

Metric FINE Thread Size	Insert LENGTH in mm	DRILL SIZES mm		HeliCoil Insert Stainless (304) Steel SPAENAUR No.	PKG QTY. Inserts only	Straight Flute TAPS Class 5H				HeliCoil HAND TOOL SPAENAUR No.
		For...	Magnesium, Plastic			For ALUMINUM		For STEEL (Mild)		
		ALUM.	STEEL			Finishing		Finishing		
						PLUG	BOTTOM	PLUG	BOTTOM	
M8 Pitch 1.00 mm	8.0	8.25	8.30	627-931	12	874-570		874-570		877-011
	12.0			627-317						
	16.0			627-318						
	20.0			627-319						
	24.0			627-320						
M10 Pitch 1.00 mm	10.0	10.25	10.25	627-321	12	874-163		874-163		877-053
	15.0			627-932						
	20.0			627-322						
	25.0			627-933						
	30.0			627-323						
M10 Pitch 1.25 mm	10.0	10.25	10.25	627-324	12	874-571		874-571		877-012
	15.0			627-325						
	20.0			627-326						
	25.0			627-327						
	30.0			627-328						
M11 Pitch 1.00 mm	11.0	7/16"	7/16"	627-934	6	874-572		874-572		877-013
		HSD-7/16	HSD-7/16							
M12 Pitch 1.25 mm	12.0	12.25	12.25	627-B91-1T	6	874-166		874-166		877-046
	18.0			627-330						
	24.0			627-331						
	30.0			627-332						
	36.0			627-333						
M12 Pitch 1.50 mm	12.0	12.25	12.50	627-334	6	874-573		874-573		877-014
	18.0			627-935						
	24.0			627-335						
	30.0			627-336						
	36.0			627-337						
M14 Pitch 1.50 mm	14.0	14.25	14.50	627-338	6	874-574		874-574		877-015
	21.0			627-936						
	28.0			627-339						
	35.0			627-340						
	42.0			875-701						
M16 Pitch 1.50 mm	16.0	16.25	16.50	627-342	6	874-575		874-575		877-016
	24.0			627-937						
	32.0			627-343						
	40.0			627-344						
	48.0			875-703						
M18 Pitch 1.50 mm	12.7	18.25	18.50	627-946	6	874-534		874-534		877-020
	18.0			627-346						
	27.0			627-347						
	36.0			627-348						
	45.0			627-349						
	54.0			875-705						

ASSORTMENT 805-466
ASSORTIMENT

METRIC
SPARK PLUG SERIES
304 Stainless Steel

Contains: 10 sizes - 60 Inserts Plus
5 Taps and 5 Installation Tools

Shipping Weight **5.67 kg** (12-1/2 lbs.)

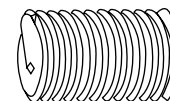

For the complete assortment contents turn to A71

See pages P25-P41 for
Inch & Metric Drill Listings

E = Economy Style
HD = Heavy Duty

© 2018 Spenaaur Inc. All rights reserved. Catalog may not be reproduced, in whole or in part, without the written permission of Spenaaur Inc. Subject to Catalog Terms and Conditions of Use available at Spenaaur.com and on page TC2 and TC3 at the back of this catalog.
© 2018 Spenaaur Inc. Tous droits réservés. Le catalogue ne peut être reproduit, en tout ou en partie, sans l'autorisation écrite de Spenaaur Inc. L'utilisation est soumise aux Conditions d'utilisation du Catalogue disponibles sur Spenaaur.com et à la page TC4 et TC5 à la fin de ce catalogue.

C215

Thread Repair Insert Kits / Tools

Kits d'inserts pour réparation de filets / Outils

STANLEY
Engineered Fastening

HeliCoil

Inch and **Metric**
Pouce et **Métrique**

Special Applications

All special size application kits are individually packed according to thread size. Complete with tap, tool, HeliCoil Stainless Steel Inserts, instructions, and drill specifications.

These items usually ordered in complete "Kits" (see Kit Part No.), but may also be specified as separate parts.

See pages P25-P41 for
Inch & **Metric** Drill Listings.

Description	Thread Size	Length	KIT SPAENAUR No.	Inserts Per Kit	Drill Size	TAP SPAENAUR No.	TOOL SPAENAUR No.	INSERTS SPAENAUR No.	PKG QTY. Inserts Only
Carburetor Fuel Inlet Repairs	7/8-20	.330	627-820	10	57/64	874-099	876-099	627-884	6
	1-20	.325	627-821	10	1-1/64	874-087	876-087	627-885	6
Cummins Engine Head Bolt	11/16-16	1.250	627-822	9	45/64	874-088	876-088	627-886	3
Caterpillar Diesel Precombustion Chamber Engines	3/4-12	.474	627-823	6	25/32	874-027	876-113	627-887	6
	7/8-12	.481	627-824	6	29/32	874-089	876-089	627-888	6
	1-12	.600		6				627-889	6
		.469	627-825	6	1-1/32	874-090	876-090		6
	.725		6				627-891	6	
1-1/8-12	.469	627-826	6	1-5/32	874-091	876-091		3	
	.609		6				627-893	3	
Harley-Davidson Cam cover screw, tappet guide, oil pump stud and timer mounting threads	1/4-24	.500	627-829	12	17/64 HSD-17/64	874-093	876-093	627-896	12
Harley-Davidson Front/Rear Brake Drum Threads	3/8-20	.375	627-830	6	25/64 HSD-25/64	874-094	876-094	627-897	6
Harley-Davidson Head Bolt Threads	7/16-16	.656	627-831	6	29/64 HSD-29/64	874-029	876-048	627-898	6
Japanese Motorcycle Head Bolt	M10 x 1.25	25.0 mm	627-900	12	13/32 HSD-13/32	874-571	877-012	627-327	12
VW Crankcase Stud Threads	M10 x 1.5	23.5 mm	627-901	80	13/32 HSD-13/32	874-576	877-005	627-947	16
VW Special Lengths	M12 x 1.5	18 mm	627-902	6	31/64 HSD-31/64	874-573	877-014		6
	M14 x 1.5	12.6 mm			9/16	874-574	877-015	627-949	3
VW Electro Magnetic Fuel Cut-off Jet	M8 x 1	8 mm	627-904	12	21/64 HSD-21/64	874-570	877-011	627-931	12
	M11 x 1	11 mm	627-905	6	7/16 HSD-7/16	874-572	877-013	627-934	6
VW Rabbit Head Bolt Threads	M11 x 1.5	16.5 mm	627-906	6	29/64 HSD-29/64	874-577	877-041	627-950	6

Tools for "Special Applications"

Application	Description	TOOL SPAENAUR No.
GM 140 CID Head Bolt/Main Bearing Thread Repair Kit Part No. 4935-7	7/16"-14 Insert Tool 29/64" drill with stop collar 6-1/8" x 1/4" drill 29/64" guide bushing/spacer 1/4" drill sleeve	876-047

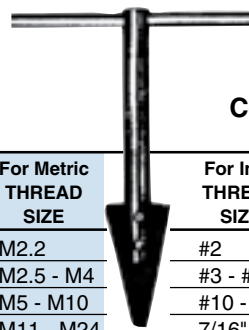

EXTRACTING TOOLS

for Inch or **Metric**
Coarse and Fine Thread

For Metric THREAD SIZE	For Inch THREAD SIZE	EXTRACTING TOOLS	
		SPAENAUR No.	HeliCoil No.
M2.2	#2	876-678	1227-02
M2.5 - M4	#3 - #8	876-679	1227-06
M5 - M10	#10 - 3/8"	876-680	1227-6
M11 - M24	7/16" - 1"	876-681	1227-16

All Taps and Tools listed separately on this page - PKG QTY. 1

Inch and Metric
Pouce et Métrique

STANLEY **HeliCoil**
Engineered Fastening

Thread Repair Insert Kits / Tools
Kits d'inserts pour réparation de filets / Outils

Heli-Coil® Thread Repair KITS - INCH SIZES

All kits contain the proper tap, installation tool, a quantity of 304 stainless steel inserts and detailed instructions.

Kits up to 3/4" thread dia. inclusive, do not include drill bit, but required bit size is listed in chart.

Kits over 3/4" thread dia. are in sturdy metal cases and include the proper high speed drill bit.

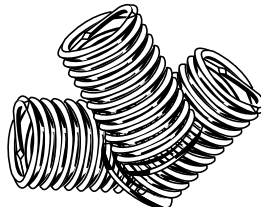

304 Stainless Steel Inserts
Standard Free-running Style

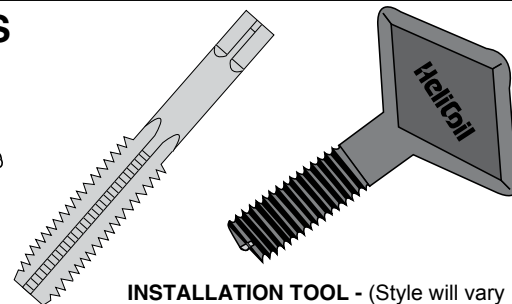

INSTALLATION TOOL - (Style will vary from kit to kit to the one shown above)

INCH COARSE THREAD KITS						INCH FINE THREAD KITS					
SPAENAUR No.	MFGR'S No.	THREAD Dia. x Pitch	INSERT LENGTH	INSERTS PER KIT	DRILL SIZE	SPAENAUR No.	MFGR'S No.	THREAD Dia. x Pitch	INSERT LENGTH	INSERTS PER KIT	DRILL SIZE
627-351	5521-2	8-32	.246"	12	11/64"	627-366	5528-3	10-32	.285"	12	13/64"
627-352	5521-3	10-24	.285"	12	13/64"	627-367	5528-4	1/4"-28	.375"	12	17/64"
627-353	5521-4	1/4"-20	.375"	12	17/64"	627-368	5528-5	5/16"-24	.469"	12	21/64"
627-354	5521-5	5/16"-18	.469"	12	21/64"	627-369	5528-6	3/8"-24	.562"	12	25/63"
627-355	5521-6	3/8"-16	.562"	12	25/64"	627-370	5528-7	7/16"-20	.656"	6	29/64"
627-356	5521-8	1/2"-13	.750"	6	17/32"	627-371	5528-8	1/2"-20	.750"	6	33/64"
627-357	5521-9	9/16"-12	.844"	6	19/32"	627-372	5528-9	9/16"-18	.844"	6	37/64"
627-358	5521-10	5/8"-11	.938"	6	21/32"	627-373	5528-10	5/8"-18	.938"	6	41/64"
627-359	5521-12	3/4"-10	1.125"	4	25/32"	627-374	5528-12	3/4"-16	1.125"	4	49/64"

INCH Kits listed below are in Steel Cases and include drill bits for 1/2" chuck

627-360	5521-14	7/8"-9	1.312"	6	29/32"	627-376	5528-16	1"-14	1.500"	6	1-1/64"
627-361	5521-16	1"-8	1.500"	6	1-1/32"	627-377	5528-161	1"-12	1.500"	6	1-1/64"
627-362	5521-18	1-1/8"-7	1.688"	5	1-5/32"	627-378	5528-18	1-1/8"-12	1.688"	5	1-5/32"
627-364	5521-22	1-3/8"-6	2.062"	4	1-13/32"	627-379	5528-20	1/1/4"-12	1.875"	4	1-9/32"
627-365	5521-24	1-1/2"-6	2.250"	4	1-17/32"	627-380	5528-22	1-3/8"-12	2.062"	4	1-13/32"
						627-381	5528-24	1-1/2"-12	2.250"	4	1-17/32"

Heli-Coil® Thread Repair Kits - METRIC SIZES

All kits contain the proper tap, installation tool, a quantity of 304 stainless steel inserts and complete instructions. (Drill bit is not included, but required bit size is listed in chart.)

METRIC COARSE THREAD KITS						METRIC FINE THREAD KITS					
SPAENAUR No.	MFGR'S No.	THREAD Dia. x Pitch (mm)	INSERT LENGTH (mm)	INSERTS PER KIT	DRILL SIZE (Inch)	SPAENAUR No.	MFGR'S No.	THREAD Dia. x Pitch (mm)	INSERT LENGTH (mm)	INSERTS PER KIT	DRILL SIZE (Inch)
627-951	5546-3	M3 x 0.5	4.5	12	1/8"	627-904	5542-8-1	M8 x 1	8.0	12	21/64"
627-952	5546-4	M4 x 0.7	6.0	12	11/64"	627-965	5542-10	M10 x 1	15.0	12	13/32"
627-953	5546-5	M5 x 0.8	7.5	12	13/64"	627-905	5543-11-1	M11 x 1	11.0	6	7/16"
627-954	5546-6	M6 x 1.0	9.0	12	1/4"	627-967	5543-10	M10 x 1.25	15.0	12	13/32"
627-955	5546-6.3	M6.3 x 1.0	9.5	12	17/64"	627-968	5543-11	M11 x 1.25	16.5	6	29/64"
627-956	5546-7	M7 x 1.0	10.5	12	9/32"	627-902	5544-12	M12 x 1.5	18.0	6	31/64"
627-957	5546-8	M8 x 1.25	12.0	12	21/64"	627-970	5544-14	M14 x 1.5	21.0	6	9/16"
627-958	5546-10	M10 x 1.5	15.0	12	13/32"	627-971	5544-16	M16 x 1.5	24.0	6	21/32"
627-906	5546-11-5	M11 x 1.5	16.5	6	29/64"						
627-959	5546-12	M12 x 1.75	18.0	6	31/64"						
627-960	5546-14	M14 x 2.0	21.0	6	37/64"						
627-961	5546-16	M16 x 2.0	24.0	6	21/32"						
627-962	5546-18	M18 x 2.5	27.0	6	47/64"						
627-963	5546-20	M20 x 2.5	30.0	4	13/16"						

All Heli-Coil® Thread Repair Kits - PKG QTY. 1

CATALOG 14

SPAENAUR