

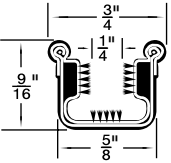







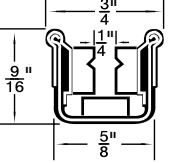

**Channels / Trim Seals**

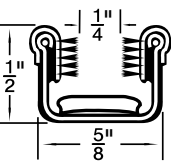
Inch

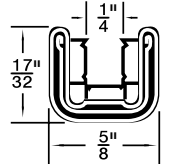
**Garnitures d'étanchéité / Profils / Joints d'étanchéité**

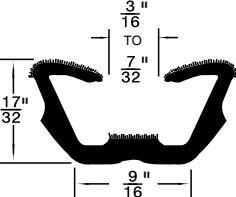
Pouce

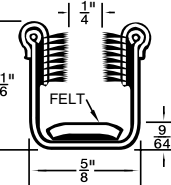
<b>CHANNEL</b>		
 <p><b>4908</b> Wool pile lined sides, felt bottom. Aluminum Beads (Bright). Rubber covered. Flexible steel core with solid bottom for extra sharp bending. <b>HIGHEST QUALITY</b> General Purpose.</p>  <p>PKG QTY. 4 LENGTHS (96")</p>	 <p><b>4908A</b> Wool felt lined, sides and bottom. Stainless steel beads (Bright). Black Fabric Back. Flexible steel core with solid bottom for extra sharp bending. <b>STANDARD QUALITY</b> General purpose.</p>  <p>PKG QTY. 4 LENGTHS (96")</p>	 <p><b>4910A</b> Wool pile lined sides, felt bottom. Beadless. Rubber covered. Flexible steel core - perforated. <b>HIGHEST QUALITY</b> General Purpose.</p>  <p>PKG QTY. 4 LENGTHS (96")</p>
 <p><b>825-B17-1T</b> Wool felt lined, sides and bottom. Beadless. Cloth covered. Flexible steel core. A universal type.</p>  <p>PKG QTY. 1 LENGTH (96")</p>	 <p><b>LC-17</b> All rubber channel with flock-coated lining.</p>  <p>PKG QTY. 4 LENGTHS (96")</p>	 <p><b>RW-63</b> Flexible unbeaded rubber covered channel wool pile fabric lining, felt bottom. Used wherever extra high leg (1 1/16") and pile side lining are desired.</p>  <p>PKG QTY. 4 LENGTHS (96")</p>

**SNAP-ON WEATHERSEAL**

**FLEXIBLE PLASTIC** (Flexible Metal Core) (also available with an Aluminum core – contact our order desk for more information)

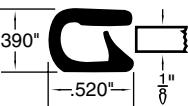
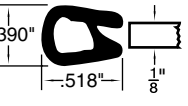
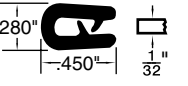
	<b>SPAENAUR No.</b>	<b>Colour</b>	<b>Panel Thickness</b>	<b>PKG QTY.</b>	 <p><b>"Q" TRIM for 1/4" Edges</b> Grips edges from .135" to .250" thick. <b>825-B35-1X</b> Black <b>825-313</b> White (With Flexible Metal or Aluminum core.) <b>PKG QTY. 250 FEET</b></p>
 <p><b>STANDARD SINGLE LIP TRIM</b> Basketweave</p>	<b>RW-85</b>	White	.032" to .125"	400'	
	<b>RW-85B</b>	Black	.032" to .125"	400'	
 <p><b>PINCH TOP SINGLE LIP TRIM</b> Sof-Tone</p>	<b>825-B11-1X</b>	Black	.060" to .170"	400'	
	<b>825-049</b>	Black	.060" to .170"	20'	
	<b>825-050</b>	White	.060" to .170"	20'	
	<b>825-091</b>	Black	.085" to .210"	300'	
 <p><b>MINITRIM DOUBLE LIP TRIM</b> Sof-Tone</p>	<b>825-509</b>	Black	.010" to .050"	250'	

**K12**

© 2018 Spenaaur Inc. All rights reserved. Catalog may not be reproduced, in whole or in part, without the written permission of Spenaaur Inc. Subject to Catalog Terms and Conditions of Use available at Spenaaur.com and on page TC2 and TC3 at the back of this catalog.  
© 2018 Spenaaur Inc. Tous droits réservés. Le catalogue ne peut être reproduit, en tout ou en partie, sans l'autorisation écrite de Spenaaur Inc. L'utilisation est soumise aux Conditions d'utilisation du Catalogue disponibles sur Spenaaur.com et à la page TC4 et TC5 à la fin de ce catalogue.

SPAENAUR CATALOG 14

Inch

# Flexible Weatherstrips / Rubber Channel Tools

Pouce

# Bourealets d'étanchéité flexibles / Outils pour profilés en caoutchouc

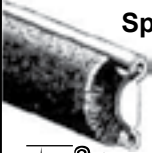

**Spaenaur No. C-9 CONTOUR WEATHERSTRIPS WITH STAINLESS STEEL BEAD**

Flexible steel core. Rubber covered. Wool pile fabric. Used on many cars and trucks since 1945, especially on hardtops.

Top bead is stainless steel.  
Bottom bead is galvanized steel.

**PKG QTY. 6 Lengths (96")**

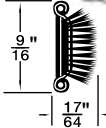
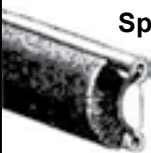



**Spaenaur No. 4912 CONTOUR WEATHERSTRIPS WITH STAINLESS STEEL BEAD**

Flexible steel core. Rubber covered. Wool pile fabric. Used on many cars and trucks since 1945, especially on hardtops.

Top bead is stainless steel.  
Bottom bead is black plated.

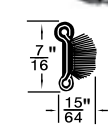
**PKG QTY. 6 Lengths (96")**



**Spaenaur No. C-54 CONTOUR WEATHERSTRIPS**

Flexible steel core. Rubber covered. Wool pile fabric. Top edge is beadless. Bottom edge has black bead. Used as belt and contour weatherstrips on many cars since 1935.

**PKG QTY. 6 Lengths (96")**





**Spaenaur No. C-55 96" long CONTOUR WEATHERSTRIPS FLEXIBLE DRAFT STRIP**

For automotive, industrial, construction and household usage. Forms draft-proof cushion between glass and lower garnish moulding.

Wool pile fabric. Rubber covered. Flexible steel core. Beadless.

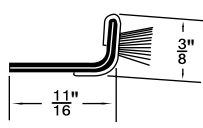
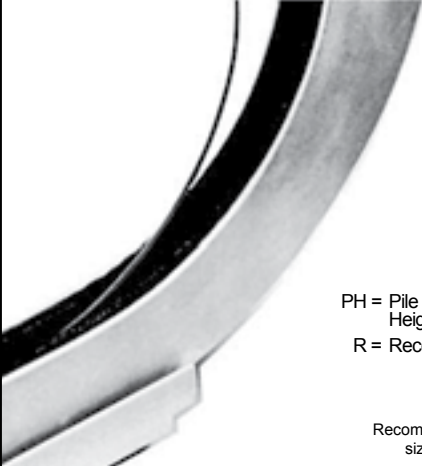
**PKG QTY. 6 Lengths (96")**





For use in: Cabs, combines, earth moving equipment, trucks, bus windows, boat windows, delivery trucks, curved windows, recreational windows and sashless windows. ● Flexible in all directions ● Economical and easy to use ● Installs easily ● Guaranteed long life ● Replaces rigid channels ● Rot, mildew and corrosion resistant.

**Flexible Channel**

Flexible Steel Core  
Woven Black Pile Lining  
Black Cloth Covering

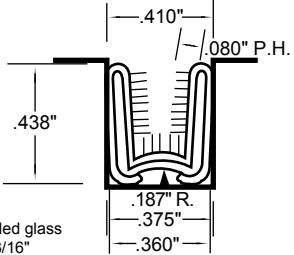
**Spaenaur No.**  
825-314 **PKG QTY. 500 Feet**  
825-347 **PKG QTY. 100 Feet**



PH = Pile Height  
R = Recess

Recommended glass size is 3/16"

## E-Z Lock Tools

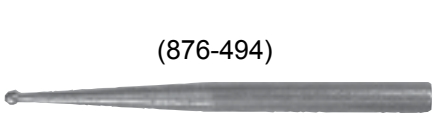

(876-494)

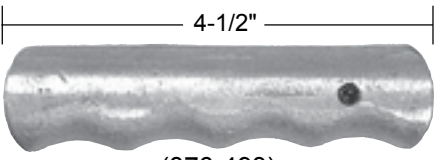

4-1/2"

(876-493)

**PKG QTY. 1**

FOR INTEGRAL LOCK, ONE PIECE SELF-SEALING WEATHERSTRIPS



**Spaenaur No.**  
876-493 Aluminum Handle  
876-494 Straight Bit  
876-591 Cornering Bit (Right Hand)

Please Note: Above items are NOT sold as a unit, but must be ordered separately.



**Spaenaur No. 876-496**

Nylon Spatula for glass insertion into rubber channel, tucking in cut ends, etc.

8" Overall Length.

**TOOL PULLS THE LOCKING STRIP INTO THE RETAINER CHANNEL**

CATALOG 14 SPAENAUR

**Channels & Weatherstrips**

Inch

**Profils et bourrelets d'étanchéité**

Pouce

**Channels**

**Spaenaur No. LC-30**

96" long

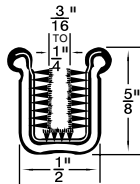

Stainless steel beads.  
Wool pile lined.

Rigid Steel Core.

**PKG QTY. 4 Lengths**

**Spaenaur No. LC-7**

96" long

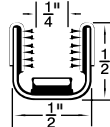

Wool pile lined sides, felt bottom.  
Rubber covered. Beadless.  
Rigid steel core.

**PKG QTY. 6 Lengths**

**Spaenaur No. LC-1**

96" long

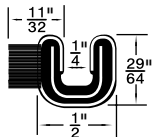

Wool pile fabric on outside of one leg.  
Cotton fabric covers outside over heavy rubber covered rigid steel core.  
Rigid glass run channel and weatherstrip for insulation between parallel panes with channel fitted to edge of one.

**PKG QTY. 6 Lengths**

**Spaenaur No. 4902**

96" long

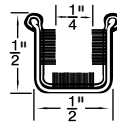

Wool pile lined all round. Rigid galvanized steel channel with stainless trim beads.

A popular multi-purpose rigid type channel.

**PKG QTY. 6 Lengths**

**Spaenaur No. 825-B10-1M**

96" long

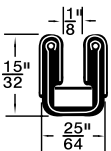

"Velvet" cloth covered sides, felt lined on bottom inside, rubber covered on bottom outside. Rigid steel core. Beadless.

A popular division bar channel for a wide range of cars. Also used on front door as lower rear channel.

**PKG QTY. 6 Lengths**

**Spaenaur No. 825-501**

96" long

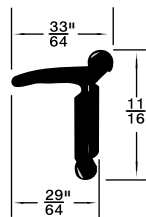

Rigid Weatherstrip  
Stainless Steel Bead  
Rubber lip  
Rubber covered Steel Core

Used on Doors, Tail-gate & Quarter Windows.

**PKG QTY. 6 Lengths**

**For General Motors "B" Body Cars**

**Spaenaur No. 825-076**

"B" Body  
Station-wagon  
Belt Weatherstrip  
Quarter-window

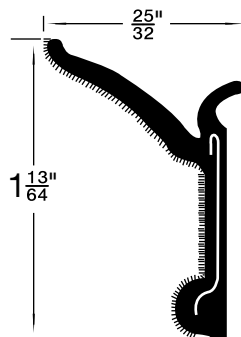

"B" 4-door  
Belt Weatherstrip  
Rear Door - Outer

**PKG QTY. 15-96" Lengths**

K

**K14**