

Extruded Channels

Inch

Profils extrudés





Pouce

Material: EPDM, Santoprene®, SBR, Neoprene, PVC, Vinyl, etc., as indicated.

(Please refer to "Elastomer Compound Characteristics" — page R19.)

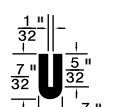
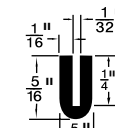
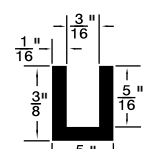
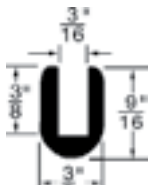
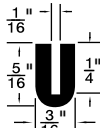
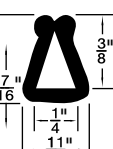
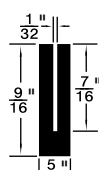
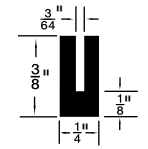
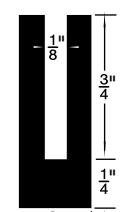
Hardness: Durometer shown under profile and No., subject to ±5.

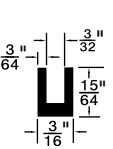
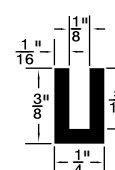
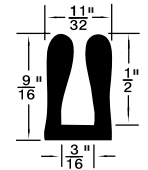
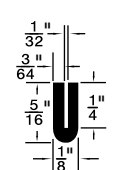
Colour: Black.

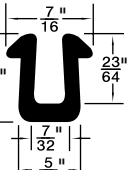
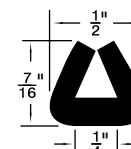
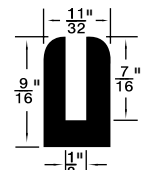
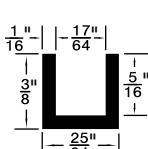
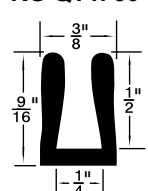
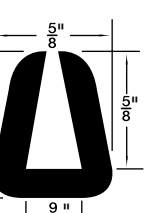
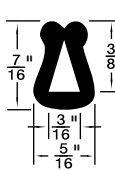
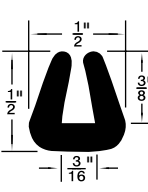
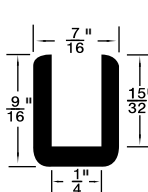
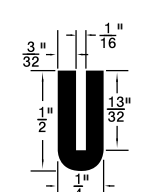
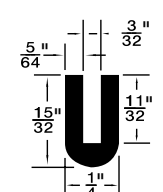
| | | | | |
|--|--|--|--|---|
|  <p>825-B19-1W EPDM Duro 70 PKG QTY. 100</p> |  <p>825-B28-1N EPDM Duro 70 PKG QTY. 100</p> |  <p>4511-A EPDM Duro 70 PKG QTY. 50</p> |  <p>825-229 EPDM Duro 50 PKG QTY. 50</p> |  <p>825-B13-2P EPDM Duro 65-75 825-B07-1A Neoprene Duro 70 PKG QTY. 50</p> |
|  <p>4517 SBR Duro 50 PKG QTY. 50</p> |  <p>RW-45 SBR Duro 65 PKG QTY. 200</p> |  <p>825-B39-1C SBR Duro 70 PKG QTY. 100</p> |  <p>825-042 Neoprene Duro 60 PKG QTY. 50</p> |  <p>825-227 Neoprene Duro 60 PKG QTY. 50</p> |
|  <p>825-B36-1A SBR Duro 70 PKG QTY. 100</p> |  <p>825-B14-1Y SBR Duro 70 PKG QTY. 50</p> |  <p>4514 SBR Duro 70 PKG QTY. 50</p> |  <p>RW-102 SBR Duro 70 PKG QTY. 100</p> |  <p>825-228 Neoprene Duro 55 PKG QTY. 50</p> |
|  <p>RW-40 SBR Duro 70 PKG QTY. 100</p> |  <p>825-B38-1Y SBR Duro 70 PKG QTY. 50</p> |  <p>RW-35 SBR Duro 70 PKG QTY. 50</p> |  <p>RW-44 SBR Duro 70 PKG QTY. 100</p> |  <p>825-B22-1M Santoprene® Duro 70 PKG QTY. 50</p> |
|  <p>C-19 SBR Duro 70 PKG QTY. 4 Lengths (11'-6")</p> |  <p>4516 SBR Duro 70 PKG QTY. 50</p> |  <p>825-B05-1N SBR Duro 70 PKG QTY. 50</p> |  <p>4588 SBR Duro 70 PKG QTY. 50</p> |  <p>825-B06-2X Santoprene® Duro 70 PKG QTY. 100</p> |
| | | | |  <p>825-B20-1K Santoprene® Duro 70 PKG QTY. 100</p> |

Continued on Next Page

CATALOG 14

SPAENAUR

Inch

Extruded Channels & Weatherstrips

Pouce

Profilés et bourrelets d'étanchéité extrudés

...Continued from previous page.

Colour: Black, unless otherwise indicated.

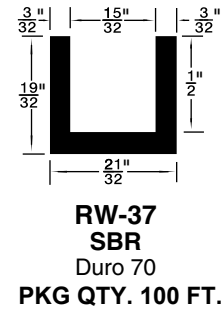
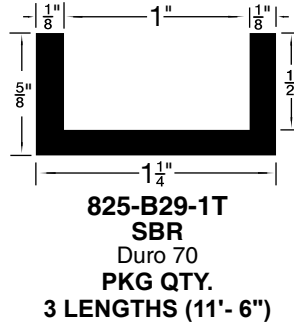
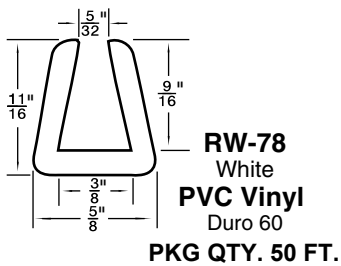
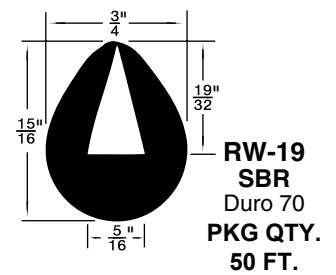
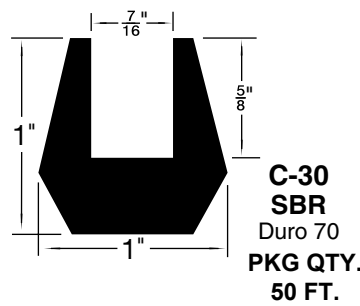
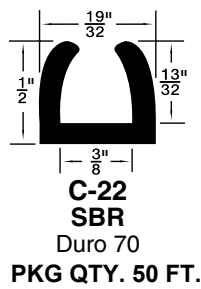
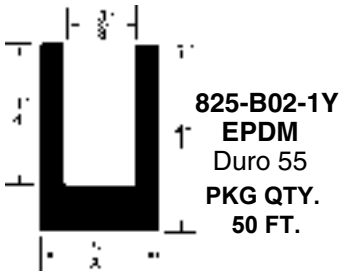

ONE PIECE SELF-SEALING WEATHERSTRIPS

Material: EPDM, or SBR as indicated.

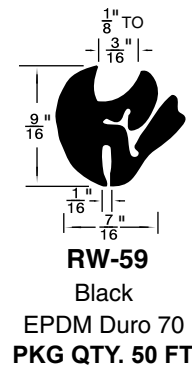
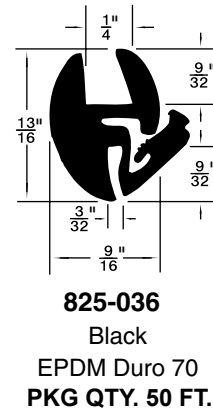
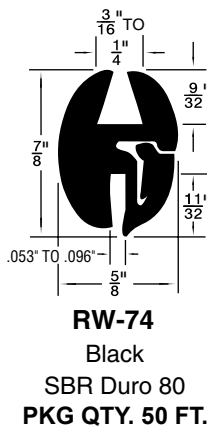
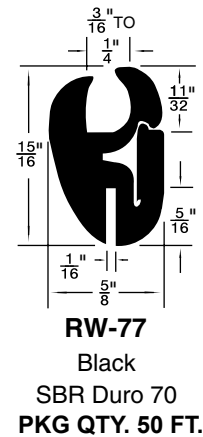
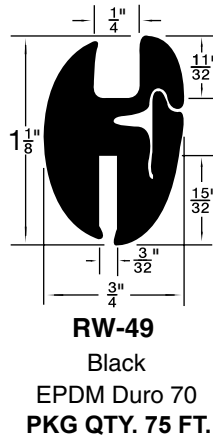
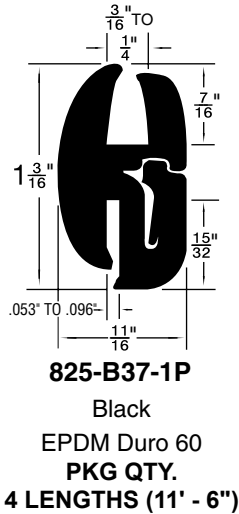

CATALOG 14 SPAENAUR

See section 'R19' for Compound Selection Guide

K

Two Piece Weatherstrips / Channel

Inch

Bourrelets d'étanchéité / profilés deux pièces

Pouce

TWO PIECE SELF-SEALING WEATHERSTRIPS

See "Elastomer Compound characteristics" - page R19.

Channel & Wedge Assembly

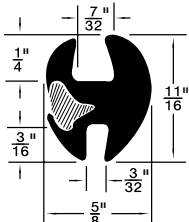
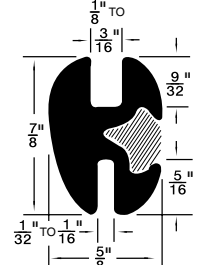
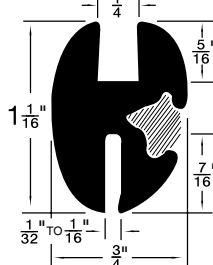
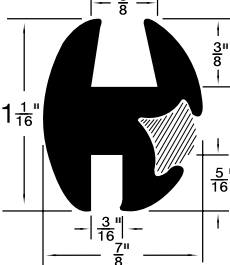
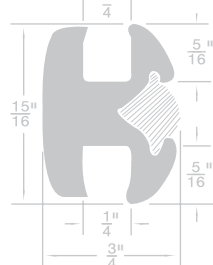
| | | | | |
|--|---|---|--|---|
|  <p>825-039 Black - EPDM Duro 70 PKG QTY. 100'</p> |  <p>C-37 Black - SBR Duro 70 PKG QTY. 50'</p> |  <p>B-900 Black - EPDM Duro 70 PKG QTY. 75'</p> |  <p>RW-92 Black - SBR Duro 70 PKG QTY. 4 Lengths (11' - 6")</p> |  <p>RW-90G Grey No longer available</p> |
|--|---|---|--|---|



Channel Only (for above)

| | | | | |
|---|--|---|---|---|
| <p>825-035 Black - SBR Duro 70 PKG QTY. 100'</p> | <p>825-283 Black - SBR Duro 70 PKG QTY. 50'</p> | <p>825-286 Black - EPDM Duro 70 PKG QTY. 75'</p> | <p>825-294 Black - SBR Duro 70 PKG QTY. 4 Lengths (11' - 6")</p> | <p>825-289 Black No longer available</p> |
|---|--|---|---|---|

Wedge Only (for above)

| | | | | |
|--|--|---|---|---|
|  <p>C-36W Black - SBR Duro 80 PKG QTY. 50'</p> |  <p>C-37W Black Santoprene® Duro 70 PKG QTY. 50'</p> |  <p>B-900W Black - EPDM Duro 80 PKG QTY. 75'</p> <p>825-012 Chrome - Vinyl Duro 80 PKG QTY. 200'</p> |  <p>B-900W Black - EPDM Duro 80 PKG QTY. 75'</p> <p>825-012 Chrome - Vinyl Duro 80 PKG QTY. 200'</p> |  <p>RW-90GW Grey No longer available</p> <p>825-012 Chrome - Vinyl Duro 80 PKG QTY. 200'</p> |
|--|--|---|---|---|

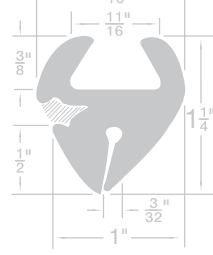
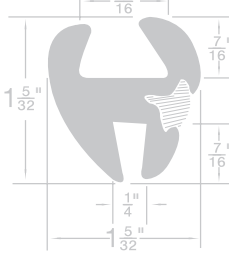



Channel & Wedge Assembly

| | | | |
|---|---|--|---|
|  <p>RW-91G Grey No longer available</p> |  <p>825-041 Black No longer available</p> |  <p>825-040 Black No longer available</p> |  <p>RW-28 Black No longer available</p> |
|---|---|--|---|

Channel Only (for above)

| | | | |
|--|---|---|---|
| <p>825-292 Black - SBR Duro 75 PKG QTY. 50'</p> | <p>825-038 Black No longer available</p> | <p>825-037 Black No longer available</p> | <p>825-298 Black No longer available</p> |
|--|---|---|---|

Wedge Only (for above)

| | | | |
|---|---|--|--|
|  <p>RW-90GW Grey No longer available</p> <p>825-012 Chrome - Vinyl Duro 80 PKG QTY. 200'</p> |  <p>C-37W Black Santoprene® Duro 70 Unit Pkg. 50'</p> |  <p>C-37W Black Santoprene® Duro 70 Unit Pkg. 50'</p> |  <p>B-900W Black - EPDM Duro 80 Unit Pkg. 75'</p> <p>825-012 Chrome - Vinyl Duro 80 PKG QTY. 200'</p> |
|---|---|--|--|

Helpful Hint: Brush liquid soap into wedge recess before installing wedge section.

K

K4

Inch

Two Piece Weatherstrips / Extruded Shapes

Pouce

Bourrelets d'étanchéité deux pièces / Formes extrudées

TWO PIECE SELF-SEALING WEATHERSTRIPS

Continued from Previous Page

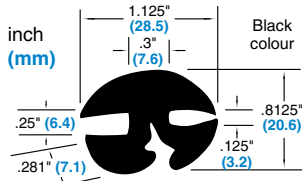

Compound: SBR 70 Duro
825-B23-1X Weatherstrip Channel only
 Compound: Santoprene 55-60 Duro
825-B24-1A Weatherstrip Channel only
PKG QTY. 150 FT.

Locking Strip
B-900W

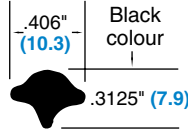

Compound: EPDM 80 Duro
B-900W
 Wedge Only
PKG QTY. 75 FT.

"WEDGE-TITE"
 COMPLETE PACKAGE
 Two-Piece Weatherstrip

825-282A

Pkg. contains:
 825-B24-1A and B-900W
 Black Santoprene 55-60
 Duro Channel + EPDM Wedge
PKG QTY. 150 FT.

(Helpful Hint: Brush liquid soap into wedge recess before installing wedge section).

Material:

EPDM, Santoprene®, SBR, Neoprene, PVC, Vinyl, Silicon, etc., as indicated.
 (Please refer to "Elastomer Compound Characteristics" - page R19.)

Hardness:

Durometer shown under profile and No., subject to ±5.

| | | | | | | |
|--|--|--|--|--|--|---|
| 825-B25-1P Santoprene® Duro 60 PKG QTY. 10 Lengths (11' - 6") | 825-B40-1Y SBR Duro 55 PKG QTY. 5 Lengths (10') | 825-223 Neoprene Duro 50 PKG QTY. 50 FT. | RW-100 SBR Duro 70 PKG QTY. 75 FT. | 825-226 Neoprene Duro 50 PKG QTY. 50 FT. | 825-043 Neoprene Duro 60 PKG QTY. 50 FT. | 825-B03-1C EPDM Duro 70 PKG QTY. 50 FT. |
|--|--|--|--|--|--|---|

| | | | | | |
|---|--|---|---|--|--|
| 825-219 SBR Duro 60 PKG QTY. 50 FT. | RW-23 SBR Duro 65 PKG QTY. 4 Lengths (11' - 6") | 4581 SBR PKG QTY. 50 FT. | 825-B27-1C Santoprene® Duro 65 PKG QTY. 4 Lengths (11' - 6") | 825-234 Grey Silicon Duro 40 PKG QTY. 60 FT. | 825-044 EPDM Duro 70 PKG QTY. 50 FT. |
|---|--|---|---|--|--|

825-305 Vinyl Duro 65
 PKG QTY. 150 FT.

RW-136
 Vinyl Duro 75
 PKG QTY. 100 FT.

SPAENAUR

| No. | W | H |
|------|------|------|
| 4530 | 1/4" | 3/4" |
| 4531 | 1/4" | 1" |

"T" Shapes
 SBR Duro 65
 PKG QTY. 50 FT.

4625
 SBR Duro 70
 PKG QTY.
 5 Lengths (10')

825-B41-1C
 PVC Duro 65
 PKG QTY. 100 FT.

(Shown twice size)

Continued on next page











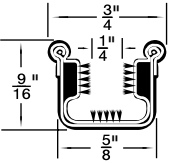

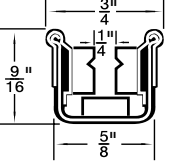
Channels / Trim Seals

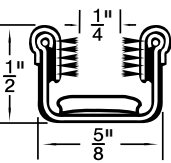
Inch

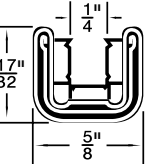
Garnitures d'étanchéité / Profilsés / Joints d'étanchéité

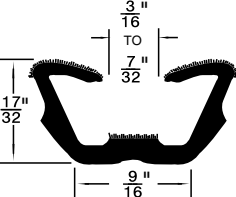
Pouce

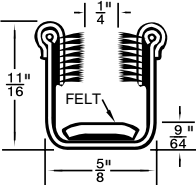
| CHANNEL | | |
|---|---|---|
|  <p>4908 Wool pile lined sides, felt bottom. Aluminum Beads (Bright). Rubber covered. Flexible steel core with solid bottom for extra sharp bending. HIGHEST QUALITY General Purpose.</p>  <p>PKG QTY. 4 LENGTHS (96")</p> |  <p>4908A Wool felt lined, sides and bottom. Stainless steel beads (Bright). Black Fabric Back. Flexible steel core with solid bottom for extra sharp bending. STANDARD QUALITY General purpose.</p>  <p>PKG QTY. 4 LENGTHS (96")</p> |  <p>4910A Wool pile lined sides, felt bottom. Beadless. Rubber covered. Flexible steel core - perforated. HIGHEST QUALITY General Purpose.</p>  <p>PKG QTY. 4 LENGTHS (96")</p> |
|  <p>825-B17-1T Wool felt lined, sides and bottom. Beadless. Cloth covered. Flexible steel core. A universal type.</p>  <p>PKG QTY. 1 LENGTH (96")</p> |  <p>LC-17 All rubber channel with flock-coated lining.</p>  <p>PKG QTY. 4 LENGTHS (96")</p> |  <p>RW-63 Flexible unbeaded rubber covered channel wool pile fabric lining, felt bottom. Used wherever extra high leg (1 1/16") and pile side lining are desired.</p>  <p>PKG QTY. 4 LENGTHS (96")</p> |

SNAP-ON WEATHERSEAL

FLEXIBLE PLASTIC (Flexible Metal Core) (also available with an Aluminum core – contact our order desk for more information)

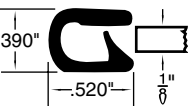
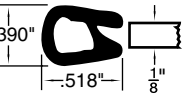
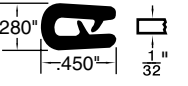
| | SPAENAUR No. | Colour | Panel Thickness | PKG QTY. |  <p>"Q" TRIM for 1/4" Edges Grips edges from .135" to .250" thick. 825-B35-1X Black 825-313 White (With Flexible Metal or Aluminum core.) PKG QTY. 250 FEET</p> |
|--|---------------------|---------------|------------------------|-----------------|--|
|  <p>STANDARD SINGLE LIP TRIM Basketweave</p> | RW-85 | White | .032" to .125" | 400' | |
| | RW-85B | Black | .032" to .125" | 400' | |
|  <p>PINCH TOP SINGLE LIP TRIM Sof-Tone</p> | 825-B11-1X | Black | .060" to .170" | 400' | |
| | 825-049 | Black | .060" to .170" | 20' | |
| | 825-050 | White | .060" to .170" | 20' | |
| | 825-091 | Black | .085" to .210" | 300' | |
|  <p>MINITRIM DOUBLE LIP TRIM Sof-Tone</p> | 825-509 | Black | .010" to .050" | 250' | |

K12

© 2018 Spenaaur Inc. All rights reserved. Catalog may not be reproduced, in whole or in part, without the written permission of Spenaaur Inc. Subject to Catalog Terms and Conditions of Use available at Spenaaur.com and on page TC2 and TC3 at the back of this catalog.
© 2018 Spenaaur Inc. Tous droits réservés. Le catalogue ne peut être reproduit, en tout ou en partie, sans l'autorisation écrite de Spenaaur Inc. L'utilisation est soumise aux Conditions d'utilisation du Catalogue disponibles sur Spenaaur.com et à la page TC4 et TC5 à la fin de ce catalogue.

SPAENAUR CATALOG 14

Inch

Flexible Weatherstrips / Rubber Channel Tools

Pouce

Boureaux d'étanchéité flexibles / Outils pour profilés en caoutchouc

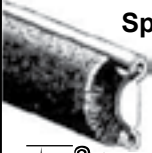

Spaenaur No. C-9 CONTOUR WEATHERSTRIPS WITH STAINLESS STEEL BEAD

Flexible steel core. Rubber covered. Wool pile fabric. Used on many cars and trucks since 1945, especially on hardtops.

Top bead is stainless steel.
Bottom bead is galvanized steel.

PKG QTY. 6 Lengths (96")

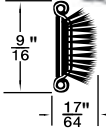
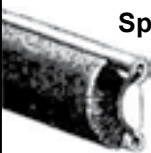



Spaenaur No. 4912 CONTOUR WEATHERSTRIPS WITH STAINLESS STEEL BEAD

Flexible steel core. Rubber covered. Wool pile fabric. Used on many cars and trucks since 1945, especially on hardtops.

Top bead is stainless steel.
Bottom bead is black plated.

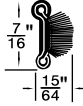
PKG QTY. 6 Lengths (96")



Spaenaur No. C-54 CONTOUR WEATHERSTRIPS

Flexible steel core. Rubber covered. Wool pile fabric. Top edge is beadless. Bottom edge has black bead. Used as belt and contour weatherstrips on many cars since 1935.

PKG QTY. 6 Lengths (96")





Spaenaur No. C-55 96" long CONTOUR WEATHERSTRIPS FLEXIBLE DRAFT STRIP

For automotive, industrial, construction and household usage. Forms draft-proof cushion between glass and lower garnish moulding.

Wool pile fabric. Rubber covered. Flexible steel core. Beadless.

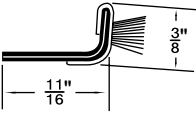
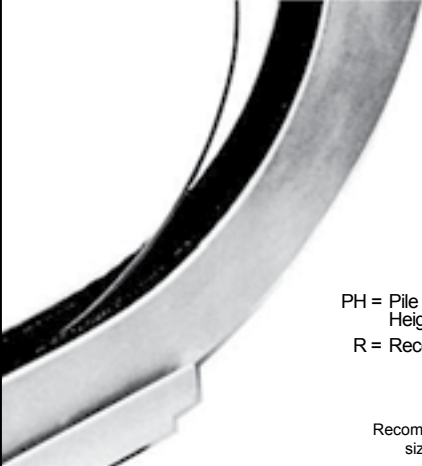
PKG QTY. 6 Lengths (96")





For use in: Cabs, combines, earth moving equipment, trucks, bus windows, boat windows, delivery trucks, curved windows, recreational windows and sashless windows. • Flexible in all directions • Economical and easy to use • Installs easily • Guaranteed long life • Replaces rigid channels • Rot, mildew and corrosion resistant.

Flexible Channel

Flexible Steel Core
Woven Black Pile Lining
Black Cloth Covering

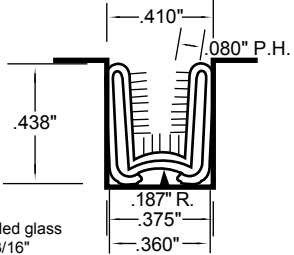
Spaenaur No.
825-314 **PKG QTY. 500 Feet**
825-347 **PKG QTY. 100 Feet**



PH = Pile Height
R = Recess
Recommended glass size is 3/16"

E-Z Lock Tools

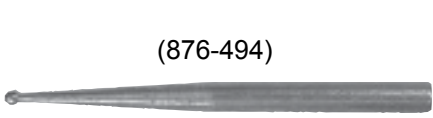

(876-494)

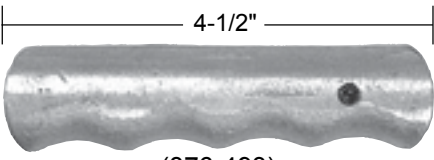

(876-493)

PKG QTY. 1

FOR INTEGRAL LOCK, ONE PIECE SELF-SEALING WEATHERSTRIPS

Spaenaur No.
876-493 Aluminum Handle
876-494 Straight Bit
876-591 Cornering Bit (Right Hand)

Please Note: Above items are NOT sold as a unit, but must be ordered separately.



Spaenaur No. 876-496

Nylon Spatula for glass insertion into rubber channel, tucking in cut ends, etc.

8" Overall Length.

TOOL PULLS THE LOCKING STRIP INTO THE RETAINER CHANNEL

CATALOG 14 SPAENAUR

Inch

Weatherstrip & Sponge Cord

Pouce

Boureaux d'étanchéité et cordon mousse

WEATHERSTRIP EXTRUSIONS — of Closed Cell **NEOPRENE** Sponge
Heat and Cold resistance — **Minus 45°C to Plus 150°C** (-40°F to +225°F)

Colour, Black
unless shown otherwise

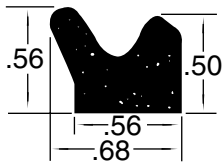

SPAENAUR No 825-319
Neoprene

SUN ROOF SEAL
(Black)

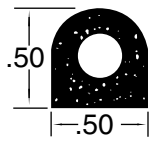

SPAENAUR No 825-B21-1W
Neoprene



SPAENAUR No 825-353
Neoprene

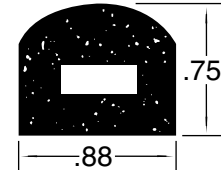

SPAENAUR No 825-321
Neoprene

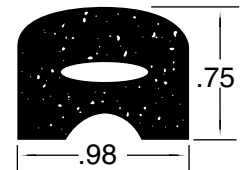

SPAENAUR No 825-322
Neoprene

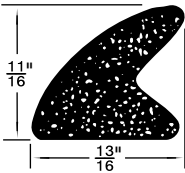

SPAENAUR No RW-2
(For Ford Cars)

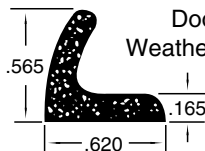

SPAENAUR No 825-057
(For Chrysler Cars)

PKG QTY. 50 FT.

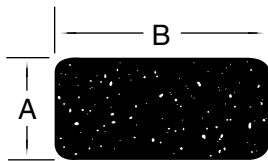

RECTANGLE

| SPAENAUR No. | A | B |
|--------------|------|------|
| 825-338 | .25" | .50" |
| 825-340 | .38" | .75" |
| 825-344 | .50" | .75" |
| Neoprene | | |

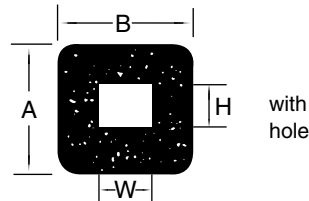

RECTANGLE & SQUARE

| SPAENAUR No. | A | B | W | H |
|--------------|------|-------|-------|-------|
| 825-330 | .50" | 1.00" | .685" | .025" |
| 825-331 | .75" | .75" | .685" | .025" |
| Neoprene | | | | |

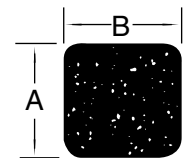

SQUARE

| SPAENAUR No. | A | B |
|--------------|------|------|
| 825-326 | .38" | .38" |
| 825-327 | .50" | .50" |
| 825-328 | .62" | .62" |
| Neoprene | | |

PKG QTY. 50 FT.

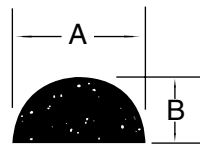

HALF ROUNDS

| SPAENAUR No. | A | B |
|--------------|------|------|
| 825-059 | .25" | .12" |
| 825-060 | .38" | .19" |
| 825-061 | .50" | .25" |
| Neoprene | | |

ROUND SPONGE CORD

Closed Cell Neoprene

| SPAENAUR No. | CORD DIA. | PKG QTY. |
|--------------|-----------|----------|
| 4658 | 3/4" Dia. | 50 FT. |

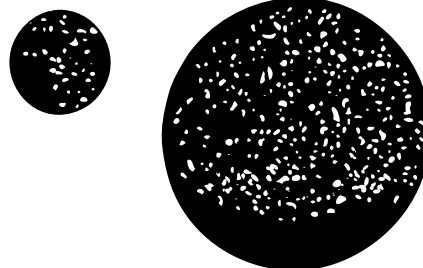

(See page K6 for Solid Neoprene Cord)

Adhesive Foam & Sponge Tape

Ruban mousse et isolant adhésif

STICKER-TITE

Inch
Pouce



EASY AND SIMPLE TO APPLY

This wonder strip is always ready to be applied to any clean surface by simply removing the liner tape which protects the adhesive surface.

Comes with Skived Finish.



PEEL and STICK

Pressure-sensitive adhesive on one side.

SBR OPEN CELL SPONGE

Medium density - Low deflection
2 to 5 lbs. per square inch.

| SPAENAUR No. | Thickness | Width | PKG QTY. |
|--------------|-----------|--------|----------|
| 360 | 5/32" | 3/8" | 200 Feet |
| 377 | | 1/2" | 150 Feet |
| 378 | | 5/8" | 100 Feet |
| 361 | 5/32" | 3/4" | 100 Feet |
| 892-W03-1K | | 1" | 100 Feet |
| 373 | | 1-3/4" | 50 Feet |
| 892-021 | 1/4" | 3/8" | 100 Feet |
| 363 | 5/16" | 3/8" | 100 Feet |
| 364 | | 1/2" | 75 Feet |
| 365 | | 5/8" | 50 Feet |
| 366 | | 3/4" | 50 Feet |
| 367 | | 1" | 50 Feet |
| 379 | 5/16" | 1-1/2" | 25 Feet |
| 375 | | 2" | 25 Feet |
| 368 | 7/16" | 3/8" | 100 Feet |
| 369 | | 1/2" | 75 Feet |
| 370 | | 3/4" | 50 Feet |
| 371 | | 1" | 50 Feet |
| 376 | 7/16" | 2" | 25 Feet |

NEOPRENE/EPT/SBR BLEND

CLOSED CELL SPONGE Medium density

| SPAENAUR No. | Thickness | Width | PKG QTY. |
|--------------|-----------|-------|----------|
| 892-W12-1A | 1/8" | 3/8" | 50 Feet |
| 892-360 | | 1/2" | 50 Feet |
| 892-W06-1K | | 3/4" | 50 Feet |
| 892-362 | 3/16" | 3/8" | 50 Feet |
| 892-363 | | 3/4" | 50 Feet |
| 892-W11-1X | | 1" | 50 Feet |
| 892-W09-2X | 1/4" | 1/4" | 100 Feet |
| 892-365 | | 3/8" | 25 Feet |
| 892-366 | | 1/2" | 25 Feet |
| 892-W04-1W | | 3/4" | 25 Feet |
| 892-367 | 5/16" | 1" | 25 Feet |
| 892-368 | | 3/8" | 25 Feet |
| 892-369 | | 1/2" | 25 Feet |
| 892-380 | | 9/16" | 25 Feet |
| 892-370 | | 3/4" | 25 Feet |
| 892-371 | 3/8" | 1" | 25 Feet |
| 892-372 | | 1/2" | 25 Feet |
| 892-373 | | 3/4" | 25 Feet |
| 892-377 | 3/8" | 1" | 25 Feet |
| 892-W07-1W | | 1/2" | 25 Feet |
| 892-381 | | 3/4" | 25 Feet |
| 892-376 | 7/16" | 1" | 25 Feet |
| 892-384 | | 1/2" | 25 Feet |

Polyester URETHANE Foam Sponge
Pressure-sensitive adhesive on one side

OPEN CELL — BLACK COLOUR
SOFT AND RESILIENT

Used as cushioning, and as draft, dust or light seal.

| SPAENAUR No. | Thickness | Width | PKG QTY. |
|--------------|-----------|-------|----------|
| 892-W13-1P | 1/4" | 1/4" | 40 Feet |
| •892-394 | | 3/8" | 40 Feet |
| 892-W01-2P | 1/2" | 3/4" | 50 Feet |

• Colour: Grey

NEOPRENE and NEOPRENE/EPDM EXTRUDED CLOSED CELL SPONGE

Ideal for applications requiring a lightweight seal with insulation and cushioning.

Advantages:

- Clean, smooth skin for a tight seal.
- Low water absorbtion.
- Resistance to structural collapse.
- Excellent insulator with good temperature range (-45 °C to +150°C).
- Ability to conform to curves, corners, varying cross sections, and irregular surfaces.

A Quality Engineered Product.

Inch

Adhesive Foam & Sponge Tape

Pouce

Ruban mousse et isolant adhésif

“EASY-OPEN”

GREY COLOUR (8 lb. density)

Closed Cell – P.V.C. (Polyvinyl Chloride)

FOAM TAPE SEALANT

With Non-Clinging Top Surface

Pressure-sensitive, with aggressive adhesive coating on one side.

Flame retardant and fungus resistant.

Mar-resistant, smooth, non-clinging top surface.

For exterior or interior closures which are subject to PERIODIC OPENING AND CLOSING, such as instrument panels and switch-gear, commercial and residential doors.

| SPAENAUR No. | Thickness | Width | PKG QTY. |
|--------------|-------------------------|--------|----------|
| 892-W08-1M | 1/8" (3.2 mm) | 1/4" | 100 FEET |
| 892-476 | | 3/8" | 100 FEET |
| 892-477 | | 1/2" | 100 FEET |
| 892-W33-1W | | 3/4" | 100 FEET |
| 892-479 | 1/4" (6.4 mm) | 3/8" | 50 FEET |
| 892-480 | | 1/2" | 50 FEET |
| 892-481 | | 19/32" | 50 FEET |
| 892-482 | | 3/4" | 50 FEET |
| 892-483 | 3/8" (9.6 mm) | 1/2" | 30 FEET |
| 892-484 | | 3/4" | 30 FEET |
| 892-485 | | 1" | 30 FEET |

| Performance Data & Properties (Typical Data for 6.4 mm material) | | Load at 50% Compression: | 5 lbs./sq.in. | Resistance To: | |
|---|--------------------|--------------------------------------|--|----------------|-----------|
| Density: | 8 lbs./cu. ft. | Test Method | ASTM D-1667 | Weather | Excellent |
| Test Method | ASTM D-1667 | Compression Set: | 8% | Fungi | Excellent |
| Ultimate Tensile Strength: | 9 lbs./in. width | Test Method | ASTM D-1667 | Combustion | Excellent |
| Test Method | PSTC-31 | Flammability: | Self-extinguishing | Oxidation | Excellent |
| Elongation: | 100 % min. | Test Method | ASTM D-1692 | Salt Water | Good |
| Test Method | PSTC-31 | Service Temperature: | Intermittently up to | Weak Acids | Good |
| Peel Adhesion: @90° | 1.5 lbs./in. width | Min. -29°C | +71°C | Weak Bases | Good |
| Test Method | PSTC 1A | (-20°F | + 160°F | Solvents | Poor |
| | | | 93°C | Petrol | Fair |
| | | | 200°F) | Lacquer Mar | Excellent |
| For “SEAL-KING” Foam Tape Sealant, see page K18. | | Recommended Application Temperature: | 18°C to 52°C (65°F to 125°F) | | |

 CATALOG 14
SPAENAUR

Adhesive Foam & Sponge Tape

Inch

Ruban mousse et isolant adhésif

Pouce

“SEAL-KING” P.V.C. (Polyvinyl Chloride)
FOAM TAPE SEALANT



CLOSED CELL - GENERAL PURPOSE

This is a low density, very aggressive adhesive foam sealant, used extensively in the automotive and other industries for permanently sealing against air, water, dust, vibration and noise.

ADHESIVE

(Acrylic Type)

Pressure Sensitive

ON ONE SIDE

BLACK colour only.

| SPAENAUR No. | Thickness | Width | PKG QTY. |
|--------------|-------------------------|-------|----------|
| 892-W10-1M | 1/8" (3.2 mm) | 3/8" | 100 feet |
| 892-W05-1M | | 1/2" | 100 feet |
| 892-W02-1Y | | 3/4" | 100 feet |
| 892-453 | | 1" | 100 feet |
| 892-454 | 3/16" (4.8 mm) | 1/2" | 50 feet |
| 892-W16-1N | 1/4" (6.4 mm) | 1/2" | 50 feet |
| 892-457 | | 3/4" | 50 feet |
| 892-458 | | 1" | 50 feet |
| 892-459 | 3/8" (9.6 mm) | 3/4" | 25 feet |
| 892-460 | | 1" | 25 feet |
| 892-461 | 1/2" (12.7 mm) | 3/4" | 25 feet |

Performance Data and Properties

Density: 6.75 ± 1.0 lb./ft³
Test Method ASTM-D-1667

Tensile Strength: 2.0 lbs./in. width min.
Test Method PSTC-31 STP-7

Service Temperature:
Min. **-29°C** (-20°F) | Max. **+71°C** (+160°F) | Intermittently up to **93°C** (200°F)

Elongation: 100% minimum
Test Method PSTC-31 STP-7

Recommended Application Temperature: **16°C to 38°C** (60°F to 100°F)

Peel Adhesion: @ 90° stronger than internal strength of foam
Test Method PSTC-1A STP-6

Resistance To:
Weather: Excellent
Fungi: Excellent

Compression/Deflection: 50% .75 +.5 — .25 psi
Test Method ASTM-D-1667 STP-10

Combustion: Poor
Oxidization: Excellent
Salt Water: Good
Weak Acids: Good
Weak Bases: Good
Solvents: Poor
Petrol: Fair

Minimum Compression to Seal at Ambient Temperature: 30%

Vinyl Release: 0.15 lbs./in. width max.
Test Method STP-2

Adhesive to Liner Release: 0.20 lbs./in. width max.
Test Method STP-2

NOTE:

“SEAL-KING”

is really a **SEALER** Foam Tape and may cling to the opposite surface if in a fixed position, over a long time.

“EASY-OPEN”

(shown on page K17 has a non-clinging top surface.)

K