

Metric

Sealing Rings

Métrique

Anneaux d'étanchéité

Metric Sealing Rings (cont'd)

DIN 7603

Form 7603A – Flat Gasket Form 7603C – Packing Gasket

Available in Aluminum Natural, Fibre Natural, Copper Natural and Copper Natural with "KFC" packing.

"KFC" packing is made from cellulose fibre and binding materials, developed for use as a filler in Sealing Rings. Good compressionability, springiness and workability - easy on forming tools. 250°C Max.

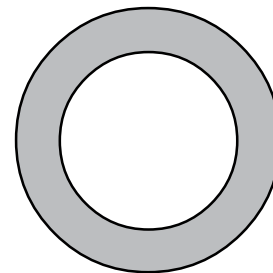

Continued from Previous Page

DIN 7603A			DIN 7603C	All Dimensions in Millimetres			DIN 7603A			DIN 7603C	All Dimensions in Millimetres			
Aluminum Natural	Fibre Natural	Copper Natural	Copper Filled with "KFC"	I.D.	O.D.	Thick.	Aluminum Natural	Fibre Natural	Copper Natural	Copper Filled with "KFC"	I.D.	O.D.	Thick.	
661-328	661-426	661-795		17	23	1	661-341		661-839		26	34	2	
		661-796		17	23	1.5			661-901		26	34	2.5	
661-329	661-427	661-797	661-888	17	23	2			661-840		27	32	1.5	
		661-798		18	22	1	661-342	661-436	661-841		27	32	2	
		661-799		18	22	1.5				661-902		27	32	2.5
		661-800	661-889	18	22	2			661-842		27	35	2	
661-330	661-428	661-801		18	24	1			661-843		28	33	2	
		661-802		18	24	1.5	661-343	661-437	661-844		28	34	2	
		661-803	661-890	18	24	2				661-903		28	34	2.5
661-331	661-429	661-804		20	24	1			661-845		28	36	2	
		661-805		20	24	1.5			661-846		30	36	1.5	
		661-806	661-891	20	24	2	661-W03-1A	661-438	661-847		30	36	2	
		661-807		20	26	1				661-904		30	36	2.5
661-332	661-430			20	26	1.5	661-345		661-848		30	38	2	
				20	26	2				661-905		30	38	2.5
661-333	661-431	661-809		21	26	1	661-346	661-439	661-849		32	38	2	
		661-810		21	26	1.5				661-906		32	38	2.5
		661-812	661-893	21	26	2			661-850		33	39	1.5	
		661-813		21	27	1	661-347	661-440	661-851		33	39	2	
661-335	661-433	661-814		21	27	1.5				661-907		33	39	2.5
		661-815		21	27	2			661-852		35	41	1.5	
		661-816		21	28	1	661-348	661-441	661-853		35	41	2	
		661-817		21	28	1.5				661-908		35	41	2.5
		661-818		21	28	2			661-854		36	42	1.5	
		661-819		22	26	1.5	661-349	661-442	661-855		36	42	2	
		661-820		22	27	1				661-909		36	42	2.5
		661-821		22	27	1.5			661-856		36	44	2	
661-336	661-434	661-822	661-894	22	27	2	661-350		661-857		38	44	2	
		661-823		22	28	1				661-910		38	44	2.5
		661-824		22	28	1.5	661-351	661-443	661-858		40	47	2	
		661-825		22	28	2				661-911		40	47	2.5
661-337	661-435	661-826		22	29	1			661-859		40	49	2	
		661-827		22	29	1.5	661-352	661-444	661-860		42	49	2	
		661-828	661-895	22	29	2				661-912		42	49	2.5
661-339	661-436	661-829		23	28	2	661-353	661-445	661-861		45	52	2	
		661-830		24	29	2				661-913		45	52	2.5
661-340	661-447		661-896	24	29	2.5			661-446	661-862		48	55	2
				24	30	2				661-914		48	55	2.5
			661-897	24	30	2.5				661-863		50	57	2
				24	32	1.5				661-864		52	60	2.5
661-339	661-435	661-833		24	32	2				661-915		52	60	3
		661-917	661-898	24	32	2.5	661-354				48	55	2	
		661-834		26	31	1.5			661-865		60	68	2.5	
		661-835		26	31	2				661-916		60	68	3
661-340	661-447		661-899	26	31	2.5				661-866		75	84	2.5
				26	32	1.5								
				26	32	2								
			661-900	26	32	2.5								
		661-838		26	34	1.5								

PKG QTY.

17 & 18 mm I.D. - 100
 20-24 mm I.D. - 50
 26-30 mm I.D. - 25
 32-75 mm I.D. - 10

CATALOG 14 SPAENAUR



Split Lockwashers / Assortment

Inch

Rondelles freins fendues / Assortiment de rondelles freins fendues

Pouce

**ASME/ANSI
B18.21.1**

**REGULAR STYLE
HELICAL - SPLIT TYPE**



D

**STEEL
Zinc Plated
and
Plain Finish**



Material	SPAENAUR No.		Nominal Bolt Size	Washer Section		PKG QTY.
	Zinc Plated	Plain Finish		Width	Thickness	
STEEL Zinc Plated and Plain Finish	663-W04-1X		2	.035"	.020"	100
	W-308		3	.040"	.025"	100
	663-W02-1W		4	.040"	.031"	100
	W-310		5	.047"	.031"	100
	W-311		6	.047"	.031"	100
	663-W03-1M		8	.055"	.040"	100
	663-W05-1A		10	.062"	.047"	100
	16-SN	663-079	1/4"	.109"	.062"	100
	17-SN	663-299	5/16"	.125"	.078"	100
	663-W06-1P	18-SNB	3/8"	.141"	.094"	100
	19-SN	663-090	7/16"	.156"	.109"	100
	20-SN		1/2"	.171"	.125"	100
	21-SN		9/16"	.188"	.141"	100
	22-SN	663-091	5/8"	.203"	.156"	100
	23-SN		3/4"	.234"	.188"	100
	W-237	W-239B	7/8"	.266"	.219"	100
	W-239		1"	.297"	.250"	100
	W-241		1-1/8"	.328"	.281"	50
	W-243		1-1/4"	.359"	.312"	50
	W-244		1-5/16"	.375"	.328"	50
	W-245		1-3/8"	.391"	.344"	25
	W-246		1-7/16"	.406"	.359"	25
	663-W09-1N		1-1/2"	.422"	.375"	25
	W-363		1-5/8"	.500"	.375"	25
W-364		1-3/4"	.500"	.375"	25	
W-365		1-7/8"	.500"	.375"	25	
W-366		2"	.500"	.375"	20	
663-002		2-1/4"	.442"	.440"	10	

**ASSORTMENT
ASSORTIMENT A-203**

Inch Sizes

**SPLIT LOCKWASHERS
Steel, Plated**



**Helical, "Regular"
and "Light" Styles**

**14 SIZES
582 PIECES**

Regular Size Drawer Size:
13-3/8" x 9-1/4" x 2"
See page A2 for Storage
Slide Rack
Shipping Weight:
2.95 kg (6-1/2 lbs.)



Style	Spaenaur No.	Bolt Size	Width	Thickness	Qty.
Light	B-488	#4	0.035"	0.020"	50
	B-489	#6	0.040"	0.025"	
	B-490	#8	0.047"	0.031"	
	663-W01-1K	#10	0.055"	0.040"	
	B-492	#12	0.062"	0.047"	
Regular	663-W05-1A	#10	0.062"	0.047"	75
	16-SN	1/4"	0.109"	0.062"	50
	17-SN	5/16"	0.125"	0.078"	
	663-W06-1P	3/8"	0.141"	0.094"	
	19-SN	7/16"	0.156"	0.109"	
	20-SN	1/2"	0.171"	0.125"	
	21-SN	9/16"	0.188"	0.141"	
	22-SN	5/8"	0.203"	0.156"	
	23-SN	3/4"	0.234"	0.188"	
				12	

CATALOG 14

SPAENAUR

Inch

Split Lockwashers

Pouce

Rondelles freins fendues



Stainless - Aluminum - Bronze

REGULAR STYLE

HELICAL - SPLIT TYPE

Dimensionally to
ASME B18.21.1

Nominal Bolt Size	Washer Section		18-8 STAINLESS STEEL	316 STAINLESS STEEL	ALUMINUM 7075-T6	SILICON BRONZE	PKG QTY.
	Width	Thickness					
2	.035"	.020"	667-P08-2N	W-2314		W-582	100
3	.040"	.025"	W-2022	W-2327		W-583	
4	.040"	.031"	667-P03-2X	667-P10-1N		W-584	
6	.047"	.031"	667-P04-2A	667-P09-1T		W-585	
8	.055"	.040"	667-P16-1A	W-2317	663-W11-1N	W-586	
10	.062"	.047"	667-P02-2M	667-P07-1C	663-305	W-587	
12	.070"	.056"	667-P12-1K			W-588	
1/4"	.109"	.062"	667-P06-2W	W-2319	663-W10-1C	665-A01-1N	
5/16"	.125"	.078"	667-P24-1K	667-P15-1X	663-301	665-A04-1W	
3/8"	.141"	.094"	667-P01-2W	W-2321	663-302	W-564	
7/16"	.156"	.109"	W-2031	667-P13-1W		665-A03-1K	
1/2"	.171"	.125"	667-P11-1T	667-P17-1P	663-306	665-A05-1M	50
5/8"	.203"	.156"	W-2033	W-2323	663-307	665-A02-1T	
3/4"	.234"	.188"	W-2034	W-2324	663-308	W-568	
7/8"	.266"	.219"	W-2035	W-2325		W-569	
1"	.297"	.250"	667-P23-1T	W-2326		W-570	

ASME
B18.21.1

REGULAR STYLE

HELICAL SPLIT TYPE



Material	SPAENAUR No.	Nominal Bolt Size	Washer Section		PKG QTY.
			Width	Thickness	
Hot Galvanized Steel	663-W07-1Y	1/4"	.109"	.062"	100
	663-083	5/16"	.125"	.078"	100
	663-084	3/8"	.141"	.094"	100
	663-085	1/2"	.171"	.125"	100
	663-086	5/8"	.203"	.156"	100
	663-087	3/4"	.234"	.188"	100
	663-088	7/8"	.266"	.219"	100
	663-089	1"	.297"	.250"	100

ASSORTMENT **805-528**

Inch Sizes
16 SIZES - 1000 PIECES

SPLIT LOCKWASHERS
(18-8) Stainless Steel
Helical, "Regular" Styles

Regular Drawer Size: 13-3/8" x 9-1/4" x 2"
See page A2 for Storage Slide Racks.

Shipping Wt. **3.62 kg** (8 lbs.)



For the complete assortment contents turn to A75

CATALOG 14

SPAENAUR

Split Lockwashers

Inch

Rondelles freins fendues

Pouce

Zinc Plated
Steel

LIGHT STYLE
SPRING STEEL LOCKWASHERS

ASME
B18.21.1



SPAENAUR No.	Nominal Bolt Size	Washer Section		PKG QTY.
		Width	Thickness	
B-495	2	.030"	.015"	100
W-153	3	.035"	.020"	100
B-488	4	.035"	.020"	100
W-248	5	.040"	.025"	100
B-489	6	.040"	.025"	100
B-490	8	.047"	.031"	100
663-W01-1K	10	.055"	.040"	100
B-492	12	.062"	.047"	100
W-115	14	.107"	.047"	100

D



Zinc Plated
Steel

HIGH-COLLAR STYLE
SPRING STEEL LOCKWASHERS

ASME
B18.21.1

High-collar style is used with:
Socket Head Cap Screws
Pages B178-B187,
B189-B192, B196-B207.
Countr-Bor Cap Screws
Page B210.

SPAENAUR No.	Nominal Bolt Size	Washer Section		PKG QTY.
		Width	Thickness	
663-W14-1W	4	.022"	.022"	100
W-339	6	.030"	.030"	100
W-340	8	.042"	.047"	100
W-341	10	.042"	.047"	100
W-342	12	.047"	.078"	100
W-343	1/4"	.047"	.078"	100
W-344	5/16"	.062"	.093"	100
W-345	3/8"	.076"	.125"	100
W-346	7/16"	.090"	.140"	100
W-347	1/2"	.103"	.172"	100
W-348	9/16"	.116"	.187"	100
W-349	5/8"	.125"	.203"	100
W-350	3/4"	.154"	.218"	100
W-351	7/8"	.182"	.234"	100
W-352	1"	.208"	.250"	100
W-353	1-1/8"	.236"	.313"	50
W-354	1-1/4"	.236"	.313"	50
W-355	1-1/2"	.292"	.375"	25

18-8
Stainless
Steel

ASME
B18.21.1

667-P05-1P	4	.022"	.022"	100
667-P18-1Y	6	.030"	.030"	100
667-P20-1Y	8	.042"	.047"	100
667-B20-1M	10	.042"	.047"	100
667-P21-1C	1/4"	.047"	.078"	100
667-P19-1C	5/16"	.062"	.093"	100
667-P14-1M	3/8"	.076"	.125"	100
667-P22-1N	1/2"	.103"	.172"	100

DOUBLE COIL STYLE
Spring Steel – Hot Galvanized Finish



SPAENAUR No.	Nominal Bolt Size	Washer Section		PKG QTY.
		Width	Thickness	
663-W08-1C	3/8"	.141"	.094"	100
W-358	1/2"	.203"	.156"	100
W-359	5/8"	.234"	.188"	100
W-360	3/4"	.266"	.219"	100

CATALOG 14

SPAENAUR



**DIN
127B**

Metric LOCKWASHERS

Split Type – Helical – Plain Ends

For use with Hex Head Cap Screws
Styles DIN 931 and DIN 933 on B156 to B171

D

All Dimensions in Millimetres				ORDER BY SPAENAUR NUMBERS BELOW						PKG QTY.
BOLT SIZE	Inside Dia.	Outside Dia.	Nom. Section Thickness	STEEL		A2 Stainless Steel	A4 Stainless Steel	Silicon Bronze		
				Plain	Zinc Plated	Yellow Zinc Plated				
2	2.1	4.4	.5	664-001	664-001ZP	664-001YZ	668-A03-1C			100
2.3	2.4	4.9	.6	664-002	664-002ZP		668-002			100
2.5	2.6	5.1	.6	664-131	664-131ZP	664-131YZ	668-A02-2Y			100
2.6	2.7	5.2	.6	664-003	664-003ZP		668-003			100
3	3.1	6.2	.8	664-C03-1A	664-004ZP	664-004YZ	668-A01-1P	668-A05-1T	666-004	100
3.5	3.6	6.7	.8	664-005	664-C13-1T	664-005YZ	668-005			100
4	4.1	7.6	.9	664-006	664-C07-1P	664-006YZ	668-006	668-028	666-006	100
5	5.1	9.2	1.2	664-007	664-007ZP	664-C09-1C	668-007	668-029	666-007	100
6	6.1	11.8	1.6	664-008	664-008ZP	664-008YZ	668-008	668-030	666-008	100
7	7.1	12.8	1.6	664-009	664-009ZP	664-009YZ	668-009			100
8	8.1	14.8	2	664-010	664-C10-1Y	664-010YZ	668-010	668-031	666-010	100
10	10.2	18.1	2.2	664-011	664-011ZP	664-011YZ	668-011	668-032	666-011	100
12	12.2	21.1	2.5	664-012	664-012ZP	664-012YZ	668-012	668-033	666-012	100
14	14.2	24.1	3	664-013	664-013ZP	664-013YZ	668-013	668-A07-1W		100
16	16.2	27.4	3.5	664-014	664-014ZP	664-014YZ	668-014	668-035	666-014	100
18	18.2	29.4	3.5	664-015	664-015ZP	664-015YZ	668-015	668-036		100
20	20.2	33.6	4	664-016	664-016ZP	664-016YZ	668-016	668-037		100
22	22.5	35.9	4	664-017	664-017ZP	664-017YZ	668-017		666-017	100
24	24.5	40	5	664-018	664-018ZP	664-018YZ	668-018	668-038		50
27	27.5	43	5	664-019	664-019ZP	664-019YZ	668-A06-1K			50
30	30.5	48.2	6	664-020	664-020ZP	664-020YZ	668-020			50
33	33.5	55.2	6	664-028	664-028ZP	664-028YZ				25
36	36.5	58.2	6	664-046	664-046ZP	664-046YZ				25
42	42.5	68.2	7	664-133						10
45	45.5	71.2	7	664-134						10
48	49.0	75	7	664-135						10
52	53.0	83	8	664-136						10

Split Lockwashers / Assortment

Metric

Rondelles freins fendues / Assortiment de rondelles freins fendues

Métrique



DIN 127A

Metric LOCKWASHERS

Split Type – Helical – Barbed Ends

For use with Hex Head Cap Screws
Styles DIN 931 and DIN 933

All Dimensions in Millimetres				ORDER BY SPAENAU NUMBERS BELOW			PKG QTY.
BOLT SIZE	Inside Dia.	Outside Dia.	Section Thickness	STEEL			
				Plain	Zinc Plated	Yellow Zinc Plated	
2.6	2.7	5.2	.6		664-081ZP		100
3	3.1	6.2	.8	664-068	664-068ZP	664-068YZ	100
3.5	3.6	6.7	.8	664-069	664-069ZP	664-069YZ	100
4	4.1	7.6	.9	664-070	664-070ZP	664-070YZ	100
5	5.1	9.2	1.2	664-071	664-071ZP	664-071YZ	100
6	6.1	11.8	1.6	664-072	664-072ZP	664-072YZ	100
7	7.1	12.8	1.6	664-074	664-074ZP	664-074YZ	100
8	8.1	14.8	2	664-075	664-075ZP	664-075YZ	100
10	10.2	18.1	2.2	664-076	664-076ZP	664-076YZ	100
12	12.2	21.1	2.5	664-078	664-078ZP	664-078YZ	100
14	14.2	24.1	3	664-080	664-080ZP	664-080YZ	100
16	16.2	27.4	3.5	664-082	664-082ZP	664-082YZ	100
18	18.2	29.4	3.5	664-083	664-083ZP	664-083YZ	100
20	20.2	33.6	4	664-084	664-084ZP	664-084YZ	100
22	22.5	35.9	4	664-085	664-085ZP	664-085YZ	100
24	24.5	40	5	664-086	664-086ZP	664-086YZ	50
27	27.5	43	5	664-088	664-088ZP	664-088YZ	50
30	30.5	48.2	6	664-090	664-090ZP	664-090YZ	50
33	33.5	55.2	6	664-092	664-092ZP	664-092YZ	25
36	36.5	58.2	6	664-094	664-094ZP	664-094YZ	25
39	39.5	61.2	6	664-125			10
42	42.5	68.2	7	664-126			10
45	45.5	71.2	7	664-127			10
48	49	75	7	664-128			10

D

ASSORTMENT 805-449 DIN 127B

Metric SPLIT LOCKWASHERS A2 STAINLESS STEEL Helical - Plain Ends



20 SIZES 950 PIECES

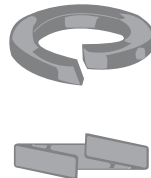

Regular Size grey enamel Steel Drawer will fit Slide Racks on page A2
Shipping Wt. **3.4 kg** (7-1/2 lbs.)

Spaenaur No.	Bolt Size	Inner Diameter	Outer Diameter	Thickness	Qty.	Page
668-001	M2	2.1mm	4.4mm	0.5mm	100	D25
668-002	M2.3	2.4mm	4.9mm	0.6mm		
668-003	M2.6	2.7mm	5.2mm	0.8mm		
668-A01-1P	M3	3.1mm	6.2mm	0.9mm	80	
668-005	M3.5	3.6mm	6.7mm	1.2mm		
668-006	M4	4.1mm	7.6mm	1.6mm	60	
668-007	M5	5.1mm	9.2mm	2.0mm	50	
668-008	M6	6.1mm	11.8mm	2.2mm	40	
668-009	M7	7.1mm	12.8mm	2.5mm		
668-010	M8	8.1mm	14.8mm	3.0mm	30	
668-011	M10	10.2mm	18.1mm	3.5mm	15	
668-012	M12	12.2mm	21.1mm	4.0mm		
668-013	M14	14.2mm	24.1mm	5.0mm	10	
668-014	M16	16.2mm	27.4mm	6.0mm		
668-015	M18	18.2mm	29.4mm		8	
668-016	M20	20.2mm	33.6mm			
668-017	M22	22.5mm	35.9mm		6	
668-018	M24	24.5mm	40.0mm			
668-A06-1K	M27	27.5mm	43.0mm		5	
668-020	M30	30.5mm	48.2mm		4	

D26

Metric

Split Lockwashers / Assortment

Métrique

Rondelles freins fendues / Assortiment de rondelles freins fendues



**DIN
7980**

Metric LOCKWASHERS

Split Type – Helical – Plain Ends

High Collar Style

For use with Socket Head Cap Screws
Style DIN 912.

All Dimensions in Millimetres				ORDER BY SPAENAUR NUMBERS BELOW					PKG QTY.
BOLT SIZE	Inside Dia.	Outside Dia.	Section Thickness	STEEL			A2 Stainless Steel	A4 Stainless Steel	
				Plain	Zinc Plated	Yellow Zinc Plated			
3	3.1	5.6	1	664-050	664-050ZP	664-050YZ	668-A04-1N	668-021	100
3.5	3.6	6.1	1	664-067	664-067ZP	664-067YZ			100
4	4.1	7	1.2	664-051	664-C02-1K	664-051YZ	668-045	668-022	100
5	5.1	8.8	1.6	664-052	664-052ZP	664-052YZ	668-046	668-023	100
6	6.1	9.9	1.6	664-053	664-053ZP	664-053YZ	668-A08-1M	668-024	100
8	8.1	12.7	2	664-054	664-054ZP	664-054YZ	668-048	668-025	100
10	10.2	16	2.5	664-055	664-055ZP	664-055YZ	668-049	668-039	100
12	12.2	18	2.5	664-056	664-056ZP	664-056YZ	668-050	668-040	100
14	14.2	21.1	3	664-057	664-C06-1A	664-057YZ			100
16	16.2	24.4	3.5	664-C12-1N	664-058ZP	664-058YZ	668-051	668-041	100
18	18.2	26.4	3.5	664-059	664-059ZP	664-059YZ			100
20	20.2	30.6	4.5	664-060	664-060ZP	664-060YZ	668-052	668-042	100
22	22.5	32.9	4.5	664-061	664-061ZP	664-061YZ			100
24	24.5	35.9	5	664-062	664-062ZP	664-062YZ		668-043	50
27	27.5	38.9	5	664-063	664-063ZP	664-063YZ			50
30	30.5	44.1	6	664-064	664-064ZP	664-064YZ			50
33	33.5	47.1	6	664-065	664-065ZP	664-065YZ			25
36	36.5	52.2	7	664-066	664-066ZP	664-066YZ			25
42	42.5	60.2	8	664-049					10

ASSORTMENT 805-413

DIN 127B

DIN 7980

for use with Hex Head Cap Screws (DIN 931/933) for use with Socket Head Cap Screws (DIN 912)

Metric SPLIT LOCKWASHERS STEEL, ZINC PLATED

Helical - Plain Ends

**24 SIZES
1381 PIECES**



Regular Size grey enamel Steel Drawer will fit Slide Racks on page A2
Shipping Wt. **3.4 kg** (7-1/2 lbs.)

Spaenaur No.	Bolt Size	Inner Diameter	Outer Diameter	Thickness	Qty.	Page
DIN 127B						
664-001ZP	M2	2.1mm	4.4mm	0.5mm	100	D25
664-002ZP	M2.3	2.4mm	4.9mm	0.6mm		
664-003ZP	M2.6	2.7mm	5.2mm	0.8mm		
664-004ZP	M3	3.1mm	6.2mm			
664-C13-1T	M3.5	3.6mm	6.7mm	0.9mm	80	
664-C07-1P	M4	4.1mm	7.6mm			
664-007ZP	M5	5.1mm	9.2mm	1.2mm	60	
664-008ZP	M6	6.1mm	11.8mm	1.6mm	50	
664-009ZP	M7	7.1mm	12.8mm		40	
664-C10-1Y	M8	8.1mm	14.8mm	2.0mm	30	
664-011ZP	M10	10.2mm	18.1mm	2.2mm		
664-012ZP	M12	12.2mm	21.1mm	2.5mm	15	
664-013ZP	M14	14.2mm	24.1mm	3.0mm		
664-014ZP	M16	16.2mm	27.4mm	3.5mm	10	
664-015ZP	M18	18.2mm	29.4mm		8	
664-016ZP	M20	20.2mm	33.6mm	4.0mm	6	
664-017ZP	M22	22.5mm	35.9mm			
664-018ZP	M24	24.5mm	40.0mm	5.0mm		
DIN 7980						
664-050ZP	M3	3.1mm	5.6mm	1.0mm	100	D27
664-C02-1K	M4	4.1mm	7.0mm	1.2mm		
664-052ZP	M5	5.1mm	8.8mm	1.6mm	80	
664-053ZP	M6	6.1mm	9.9mm		70	
664-054ZP	M8	8.1mm	12.7mm	2.0mm	50	
664-055ZP	M10	10.2mm	16.0mm	2.5mm	40	

Split Lockwashers / Tab Lockwashers

Metric

Rondelles freins fendues / Rondelles freins d'écrous à ergots

Métrique

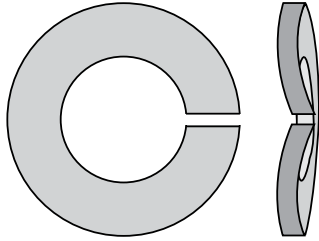

**DIN
128A**

Metric

LOCKWASHERS
Split Bowed Type – Plain Ends

■ A2 Stainless Steel specification similar to DIN 128A.

All Dimensions in Millimetres

ORDER BY SPAENAUR NUMBERS BELOW

BOLT SIZE	Min. Inside Dia.	Max. Outside Dia.	Nom. Thickness (Ref. Only)	ORDER BY SPAENAUR NUMBERS BELOW					PKG QTY.
				Plain	STEEL Zinc Plated	Yellow Zinc Plated	■ A2 Stainless Steel	A2 Stainless Steel Section Thick.	
2	2.1	4.4	0.5	664-030	664-030ZP	664-030YZ	664-900	0.6	100
2.3	2.4	4.9	0.6	-	664-031ZP	664-031YZ			100
2.5	2.6	5.1	0.6	664-032	664-032ZP	664-032YZ	664-902	0.6	100
2.6	2.7	5.2	0.6	664-033	664-033ZP	664-033YZ			100
3	3.1	6.2	0.7	664-034	664-034ZP	664-034YZ		0.8	100
3.5	3.6	6.7	0.7	664-035	664-035ZP	664-035YZ		0.8	100
4	4.1	7.6	0.8	664-036	664-C08-1Y	664-036YZ	664-908	0.8	100
5	5.1	9.2	1.0	664-037	664-037ZP	664-037YZ	664-910	1.2	100
6	6.1	11.8	1.3	664-038	664-038ZP	664-038YZ	664-912	1.5	100
7	7.1	12.8	1.3	664-095	664-095ZP	664-095YZ			100
8	8.1	14.8	1.6	664-039	664-039ZP	664-039YZ	664-914	1.9	100
10	10.2	18.1	1.8	664-C11-1C	664-040ZP	664-040YZ	664-916	2.0	100
12	12.2	21.1	2.1	664-041	664-041ZP	664-041YZ	664-C04-1M	2.4	100
14	14.2	24.1	2.4	664-042	664-042ZP	664-042YZ			100
16	16.2	27.4	2.8	664-043	664-043ZP	664-043YZ	664-920	3.3	100
18	18.2	29.4	2.8	664-044	664-044ZP	664-044YZ	664-922	3.4	100
20	20.2	33.6	3.2	664-045	664-045ZP	664-045YZ			100
22	22.5	35.9	3.2	664-096	664-096ZP	664-C05-1X			100
24	24.5	40	4.0	664-097	664-097ZP	664-097YZ			50
27	27.5	43	4.0	664-098	664-098ZP	664-098YZ			50
30	30.5	48.2	6.0	664-099	664-099ZP	664-099YZ			50
33	33.5	-	-	664-100	664-100ZP	664-100YZ			25
36	36.5	58.2	6.0	664-101	664-101ZP	664-101YZ			25

METRIC LONG TAB WASHERS (LOCKING)

Steel, Plain Finish

DIN 93

For Bolt Size	SPAENAUR No.	I.D. (d ₁)	O.D. (d ₂)	Tab Width (b)	Tab Length (l)	Radius (r)	Thick. (s)	PKG QTY.
M3	657-100	3.2	12	4	13	2.5	0.38	100
M3.5	657-101	3.7	12	4	13	2.5	0.38	100
M4	657-102	4.3	14	5	14	2.5	0.38	100
M5	657-103	5.3	17	6	16	2.5	0.5	100
M6	657-104	6.4	19	7	18	4	0.5	100
M8	657-105	8.4	22	8	20	4	0.75	100
M10	657-106	10.5	26	10	22	6	0.75	100
M12	657-107	13	30	12	28	10	1	100
M14	657-108	15	33	12	28	10	1	100
M16	657-109	17	36	15	32	10	1	100
M18	657-110	19	40	18	36	10	1	100
M20	*657-111	21	42	18	36	10	1	50
M22	657-112	23	50	20	42	10	1	50
M24	657-113	25	50	20	42	10	1	50
M27	657-114	28	58	23	48	16	1.6	25
M30	657-115	31	63	26	52	16	1.6	25
M33	657-W12-1T	34	68	28	56	16	1.6	10
M36	657-117	37	75	30	60	16	1.6	10

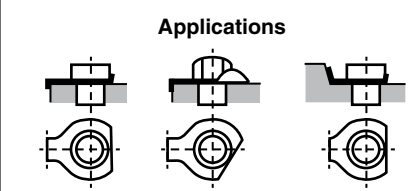
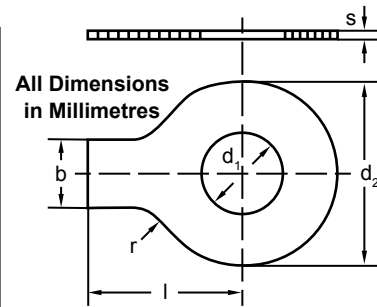

*657-111ZP Zinc Plated

Metric

Split Lockwashers / Tab Lockwashers

Métrique

Rondelles freins fendues / Rondelles freins d'écrous à ergots

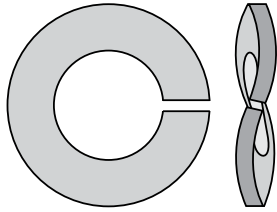

DIN 128B

Metric LOCKWASHERS
Split Twisted Type – Plain Ends

All Dimensions in Millimetres				ORDER BY SPAENAUR NUMBERS BELOW			PKG QTY.
BOLT SIZE	Min. Inside Dia.	Max. Outside Dia.	Nom. Section (Reference only)	STEEL			
				Plain	Zinc Plated	Yellow Zinc Plated	
2	2.1	4.4	.5	664-102	664-102ZP	664-102YZ	100
2.3	2.4	4.9	.6	664-103	664-103ZP	664-103YZ	100
2.5	2.6	5.1	.6	664-104	664-104ZP	664-104YZ	100
2.6	2.7	5.2	.6	664-105	664-105ZP	664-105YZ	100
3	3.1	6.2	.7	664-106	664-106ZP	664-106YZ	100
3.5	3.6	6.7	.7	664-107	664-107ZP	664-107YZ	100
4	4.1	7.6	.8	664-108	664-C01-1T	664-108YZ	100
5	5.1	9.2	1	664-109	664-109ZP	664-109YZ	100
6	6.1	11.8	1.3	664-110	664-110ZP	664-110YZ	100
7	7.1	12.8	1.3	664-111	664-111ZP	664-111YZ	100
8	8.2	14.9	1.6	664-112	664-112ZP	664-112YZ	100
10	10.2	18.1	1.8	664-113	664-113ZP	664-113YZ	100
12	12.2	21.1	2.1	664-114	664-114ZP	664-114YZ	100
14	14.2	24.1	2.4	664-115	664-115ZP	664-115YZ	100
16	16.2	27.4	2.8	664-116	664-116ZP	664-116YZ	100
18	18.2	29.4	2.8	664-117	664-117ZP	664-117YZ	100
20	20.2	33.6	3.2	664-118	664-118ZP	664-118YZ	100
22	22.5	35.9	3.2	664-119	664-119ZP	664-119YZ	100
24	24.5	40	4	664-120	664-120ZP	664-120YZ	50
27	27.5	43	4	664-121	664-121ZP	664-121YZ	50
30	30.5	48.2	6	664-122	664-122ZP	664-122YZ	50
33	33.5			664-123	664-123ZP	664-123YZ	25
36	36.5	58.2	6	664-124	664-124ZP	664-124YZ	25

Metric TAB WASHERS with LONG and SHORT TAB (LOCKING)

All Dimensions in Millimetres

For Bolt Size	Use SPAENAUR No.	I.D. (d ₁)	O.D. (d ₂)	Tab Width (b)	Tab1 Length (l ₁)	Tab2 Length (l ₂)	Thick. (s)	PKG QTY.
M3	657-118	3.2	7	4	13	5	0.38	100
M4	657-119	4.3	9	5	14	6.5	0.38	100
M5	657-120	5.3	10	6	16	8	0.5	100
M6	657-121	6.4	12.5	7	18	9	0.5	100
M8	657-122	8.4	17	8	20	11	0.75	100
M10	657-123	10.5	21	10	22	13	0.75	100
M12	657-124	13	24	12	28	15	1	100
M14	657-125	15	28	12	28	16	1	100
M16	*657-126	17	30	15	32	18	1	100
M18	657-145	19	34	18	36	20	1	100
M20	657-127	21	37	18	36	21	1	50
M22	657-128	23	39	20	42	23	1	50
M24	657-129	25	44	20	42	25	1	50
M27	657-130	28	50	23	48	29	1.6	25
M30	▲657-131	31	56	26	52	32	1.6	25
M33	657-132	34	60	28	56	34	1.6	10
M36	657-133	37	66	30	60	38	1.6	10
M42	657-W10-1C	43	78	35	70	44	1.6	10

DIN 463

Carbon Steel – Plain Finish

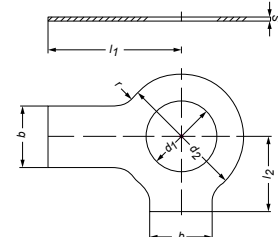

Application
(Metric Long Tab Washers on D28.)

* 657-126ZP - Zinc Plated
▲ 657-131ZP - Zinc Plated



Tooth Lockwashers

Inch

Rondelles freins dentées

Pouce

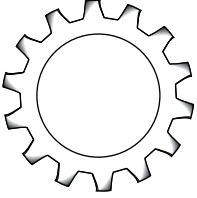
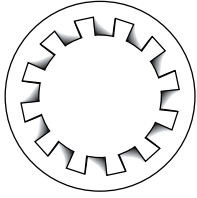
D

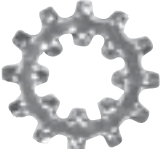
Dimensionally to ASME B18.21.1	Nominal Screw or Bolt Size	DIMENSIONS		ORDER BY SPAENAUR NUMBERS LISTED BELOW			
		Outside Diameter	Thickness	Zinc Plated STEEL	410 STAINLESS STEEL	PHOSPHOR BRONZE	
 <p>EXTERNAL TOOTH (Flat)</p>	2	.285-.275"	.018"	W-215			
	4	.260-.245"	.019-.015"	42-SN	675-A01-2A	W-545	
	6	.320-.305"	.022-.016"	43-SN	W-2047	673-A03-1N	
	8	.381-.365"	.023-.018"	44-SN	675-A03-2Y	W-547	
	10	.410-.395"	.025-.020"	671-W04-1W	675-A08-1W	673-A04-1T	
	12	.475-.460"	.028-.023"	145-A	675-A09-1M		
	1/4"	.510-.494"	.028-.023"	145	675-A10-1W	673-A06-1W	
	5/16"	.610-.588"	.034-.028"	47-SN	675-A04-1C		
	3/8"	.694-.670"	.040-.032"	49-SN	W-2053		
	7/16"	.760-.740"	.040-.032"	1351	W-2054		
	1/2"	.900-.880"	.045-.037"	1352	W-2055		
	9/16"	.985-.960"	.045-.037"	1349			
	5/8"	1.070-1.045"	.050-.042"	1481	W-2056		
	11/16"	.922-.914"	.035"	671-003			
3/4"	1.260-1.220"	.055-.047"	51-SN	W-2057	673-001		
1"	-	-	671-006				
 <p>INTERNAL TOOTH (Flat)</p>	2	.200-.175"	.015-.010"		675-A11-1M		
	3	.232-.215"	.019-.012"	W-144			
	4	.270-.255"	.019-.015"	671-W09-1Y	675-A02-2N	W-550	
	5	.280-.245"	.021-.017"	671-002		W-571	
	6	.295-.275"	.021-.017"	671-W07-1X	675-A05-1N	W-541	
	8	.340-.325"	.023-.018"	671-W11-1Y	675-A06-1T	W-542	
	10	.381-.365"	.025-.020"	671-W03-1K	W-2062	673-A01-1Y	
	12	.410-.394"	.025-.020"	1741	W-2063	W-572	
	1/4"	.478-.460"	.028-.023"	788	W-2064	W-544	
	1/4"	.536-.524"	.039"	W-391			
	5/16"	.610-.594"	.034-.028"	55-SN	W-2065	673-A02-1C	
	3/8"	.692-.670"	.040-.032"	671-W12-1C	675-A07-1K	673-A05-1K	
	7/16"	.789-.740"	.040-.032"	57-SN	W-2066	W-575	
	1/2"	.900-.867"	.045-.037"	671-W01-1N	W-2067	W-576	
	5/8"	1.071-1.045"	.050-.042"	B-404	W-2068	W-578	
	.725-.704"	1.166-1.147"	.045"	671-004			
3/4"	1.245-1.220"	.055-.047"	B-405	675-001	W-579		
7/8"	1.410-1.364"	.060-.052"	B-919				
1"	1.637-1.590"	.067-.059"	B-493				
1-1/8"	1.830-1.799"	.067-.059"	B-859				
1-5/16"	1.950-1.921"	.063"	B-860				
 <p>Zinc Plated STEEL</p> <p>EXTERNAL TOOTH 82° COUNTERSUNK</p>	SPAENAUR No.	Screw Size	 <p>Zinc Plated STEEL</p> <p>INTERNAL-EXTERNAL FLAT</p> <p>■ W-259YZ Yellow Zinc Plated</p>	SPAENAUR No.	Screw Size	Outside Diameter	Nom. Thick.
	1063	6		671-061	6	.510-.495"	.024"
	671-W02-1T	8		671-062	8	.610-.580"	.030"
	888	10		671-063	10	.610-.580"	.030"
	671-W05-1M	12		671-W10-1P	1/4"	.760-.720"	.035"
	1072	1/4"		671-065	5/16"	.900-.865"	.035"
	901	5/16"		■ W-259	3/8"	.985-.965"	.040"
58-SN	3/8"	671-066	1/2"	1.260-1.220"	.050"		
W-335	7/16"	671-069	5/8"	1.620-1.590"	.062"		

CATALOG 14 SPAENAUR

D30

Inch

Tooth Lockwashers Assortments

Pouce

Assortiments de rondelles freins dentées

ASSORTIMENT 4640-S

Tooth Lockwashers

Steel, Zinc Plated
30 VARIETIES
877 PIECES

Furnished in a Regular Size grey enamelled steel drawer with hinged lid and scooped bins. Drawer will fit Slide Racks shown on page A2

Shipping Weight: **2.6 kg** (5.75 lbs.)



ASSORTIMENT 805-529

Tooth Lockwashers

410 Stainless Steel
18 VARIETIES
1050 PIECES

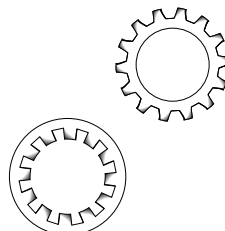

For the complete assortment contents turn to A77

ASSORTIMENT 805-533

**TOOTH LOCKWASHERS
PHOSPHOR BRONZE
16 VARIETIES - 1000 PIECES**

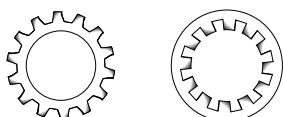

Furnished in a Regular Size grey enamelled steel drawer with hinged lid and scooped bins. Drawer will fit Slide Racks shown on page A2

Shipping Weight **2.04 kg** (4-1/2 lbs.)

Spaenaur No.	Screw / Bolt Size	Outer Diameter	Thickness	Qty.	Page
External Tooth Flat					
W-545	#4	0.260" - 0.245"	0.019" - 0.015"	100	D30
673-A03-1N	#6	0.320" - 0.305"	0.022" - 0.016"		
W-547	#8	0.381" - 0.365"	0.023" - 0.018"		
W-548	#10	0.410" - 0.395"	0.025" - 0.020"		
673-A06-1W	1/4"	0.510" - 0.494"	0.028" - 0.023"	50	D30
Internal Tooth Flat					
W-550	#4	0.270" - 0.255"	0.019" - 0.015"	50	D30
W-571	#5	0.280" - 0.245"	0.021" - 0.017"		
W-541	#6	0.285" - 0.275"	0.021" - 0.017"		
W-542	#8	0.340" - 0.325"	0.023" - 0.018"	100	
673-A01-1Y	#10	0.381" - 0.365"	0.025" - 0.020"		
W-572	#12	0.410" - 0.394"		50	
W-544	1/4"	0.478" - 0.460"	0.028" - 0.023"	50	
673-A05-1K	3/8"	0.692" - 0.670"	0.040" - 0.032"	20	
W-576	1/2"	0.900" - 0.867"	0.045" - 0.037"	10	
W-578	5/8"	1.071" - 1.045"	0.050" - 0.042"		
W-579	3/4"	1.245" - 1.220"	0.055" - 0.047"		

PLASTIKIT «PLASTIKIT» 1706

**TOOTH LOCKWASHER
STEEL ZINC PLATED
19 VARIETIES - 175 PIECES**

Put up in a clear durable plastic container with hinged lid.
Size: 1" x 2-3/4" x 4-1/2"

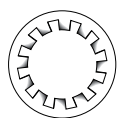
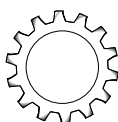



Spaenaur No.	Screw / Bolt Size	Outer Diameter	Thickness	Qty.	Page		
External Tooth Flat							
671-W04-1W	#10	0.410" - 0.395"	0.025" - 0.020"	15	D30		
145-A	#12	0.475" - 0.460"	0.028" - 0.023"				
145	1/4"	0.510" - 0.494"	0.028" - 0.023"				
47-SN	5/16"	0.588" - 0.610"	0.034" - 0.028"				
49-SN	3/8"	0.694" - 0.670"	0.040" - 0.032"				
1351	7/16"	0.760" - 0.740"	0.040" - 0.032"				
1352	1/2"	0.900" - 0.880"	0.045" - 0.037"				
1349	9/16"	0.985" - 0.960"	0.045" - 0.037"				
1481	5/8"	1.070" - 1.045"	0.050" - 0.042"				
51-SN	3/4"	1.260" - 1.220"	0.055" - 0.047"				
Internal Tooth Flat							
671-W03-1K	#10	0.381" - 0.365"	0.025" - 0.020"			15	
1741	#12	0.410" - 0.394"				20	
788	1/4"	0.478" - 0.460"	0.028" - 0.023"			10	
55-SN	5/16"	0.610" - 0.594"	0.034" - 0.028"	5			
671-W12-1C	3/8"	0.692" - 0.670"	0.040" - 0.032"				
57-SN	7/16"	0.789" - 0.740"	0.040" - 0.032"	4			
671-W01-1N	1/2"	0.867" - 0.900"	0.045" - 0.037"	2			
B-404	5/8"	1.071" - 1.045"	0.050" - 0.042"				
B-405	3/4"	1.245" - 1.220"	0.055" - 0.047"				

Tooth Lockwashers

Metric

Rondelles freins dentées

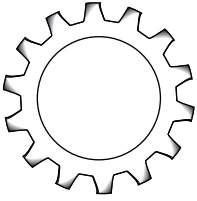
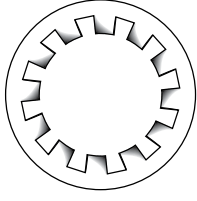
Métrique

METRIC	ORDER BY SPAENAUR NUMBERS BELOW.					Dimensions in mm				PKG QTY.
	STEEL			A2 STAINLESS STEEL	PHOSPHOR BRONZE	NOM. SIZE (Screw Size) mm	I.D.	O.D.	T	
	Plain	Zinc Plated	Yellow Zinc Plated							
 <p>DIN 6797A</p> <p>EXTERNAL TOOTH (Flat)</p>	672-029	672-029ZP	672-029YZ	676-001		2	2.2	4.5	0.3	100
	672-036	672-036ZP	672-036YZ			2.3	2.5	5.	0.4	100
	W-282	W-282ZP	W-282YZ			2.5	2.7	5.5	0.4	100
	672-037	627-037ZP	672-037YZ	676-F03-1K		2.6	2.8	5.5	0.4	100
	672-020	672-020ZP	672-020YZ	676-003	674-003	3	3.2	6.	0.4	100
	672-030	672-030ZP	672-030YZ	676-004	674-004	3.5	3.7	7.	0.5	100
	672-021	672-021ZP	672-021YZ	676-005	674-005	4	4.3	8.	0.5	100
	672-022	672-022ZP	672-022YZ	676-006	674-006	5	5.3	10.	0.6	100
	672-023	672-023ZP	672-023YZ	676-007	674-007	6	6.4	11.	0.7	100
			672-039YZ			7	7.4	12.5	0.8	100
	672-024	672-024ZP	672-024YZ	676-009		8	8.4	15.	0.8	100
	672-025	672-025ZP	672-025YZ	676-010	674-010	10	10.5	18.	0.9	100
	672-026	672-026ZP	672-026YZ	676-011		12	12.5	20.5	1.	100
	672-040	672-040ZP	672-040YZ			13	13.2	22	2.5	100
	672-027	672-027ZP	672-027YZ	676-012		14	14.5	24.	1.	100
	672-028	672-028ZP	672-028YZ	676-013	674-013	16	16.5	26.	1.2	100
	672-032	672-032ZP	672-032YZ	676-014		18	19.	30.	1.4	100
	672-033	672-033ZP	672-033YZ	676-015		20	21.	33.	1.4	50
	672-034	672-034ZP	672-034YZ	676-016		24	25.	38.	1.5	50
672-041	672-041ZP	672-041YZ			27	28.	44.	1.6	50	
672-035	672-035ZP	672-035YZ	676-017		30	31.	48.	1.6	50	
 <p>DIN 6797J</p> <p>INTERNAL TOOTH (Flat)</p>	W-306	W-306ZP	W-306YZ	676-018		2	2.2	4.5	0.3	100
	672-018	672-018ZP	672-018YZ			2.3	2.5	5.	0.4	100
	672-011	672-011ZP	672-011YZ	676-F04-1W		2.5	2.7	5.5	0.4	100
	672-019	672-019ZP	672-019YZ			2.6	2.8	5.5	0.4	100
	672-001	672-K03-1T	672-001YZ	676-F01-1N		3	3.2	6.	0.4	100
	672-012	672-012ZP	672-012YZ	676-021		3.5	3.7	7.	0.5	100
	672-002	672-K02-1N	672-002YZ	676-022	674-022	4	4.3	8.	0.5	100
	672-003	672-003ZP	672-003YZ	676-023	674-E01-1P	5	5.3	10.	0.6	100
	672-004	672-K05-1W	672-004YZ	676-024		6	6.4	11.	0.7	100
	672-043					7	7.4	12.5	0.8	100
	672-005	672-005ZP	672-005YZ	676-026	674-026	8	8.4	15.	0.8	100
	672-006	672-006ZP	672-006YZ	676-027		10	10.5	18.	0.9	100
	672-007	672-007ZP	672-007YZ	676-028		12	13.0	20.5	1.	100
	672-044	672-044ZP	672-044YZ			13	13.2	22	2.5	100
	672-008	672-008ZP	672-008YZ	676-029		14	14.5	24.	1.	100
	672-009	672-009ZP	672-009YZ	676-030		16	16.5	26.	1.2	100
	672-014	672-014ZP	672-014YZ	676-031		18	19.	30.	1.4	100
672-015	672-015ZP	672-015YZ	676-032		20	21.	33.	1.4	50	
672-016	672-016ZP	672-016YZ	676-033		24	25.	38.	1.5	50	
672-045	672-045ZP	672-045YZ			27	28.	44.	1.6	50	
672-017	672-017ZP	672-017YZ	676-034		30	31.	48.	1.6	50	
 <p>DIN 6797V</p> <p>EXTERNAL TOOTH 90° Countersunk</p>		672-087				3.5	3.7	7.	0.25	100
		672-088				4	4.3	8.	0.25	100
		672-089				5	5.3	9.8	0.3	100
		672-090				6	6.4	11.8	0.4	100
		672-092				8	8.4	15.3	0.4	100
		672-K06-1M				10	10.5	19.	0.5	100
		672-094				12	12.5	23.	0.5	100
	672-095				14	14.5	26.3	0.6	100	
	672-096				16	16.5	30.2	0.6	100	

CATALOG 14





SPAENAUR

Metric

Tooth Lockwashers

Métrique

Rondelles freins dentées

METRIC		ORDER BY SPAENAUR NUMBERS BELOW				Dimensions in mm				PKG QTY.
		STEEL		A2 STAINLESS STEEL	NOM. SIZE (Screw Size) mm	I.D.	O.D.	T		
STYLES	Plain	Zinc Plated	Yellow Zinc Plated							
 <p>DIN 6798A</p> <p>Carbon Steel</p> <p>Heat Treated</p>  <p>EXTERNAL TOOTH</p> <p>*672-055PH Black Phosphate Finish</p>	672-050	672-050ZP	672-050YZ	676-035	2	2.2	4.5	0.3	100	
	672-051	672-051ZP	672-051YZ	676-036	2.5	2.7	5.5	0.4	100	
	672-052	672-052ZP	672-052YZ	676-037	3	3.2	6.0	0.4	100	
	672-053	672-053ZP		676-038	3.5	3.7	7.0	0.5	100	
	672-054	672-K07-1X	672-054YZ	676-039	4	4.3	8.0	0.5	100	
	*672-055	672-K08-1A	672-055YZ	676-040	5	5.3	10.0	0.6	100	
	672-056	672-056ZP	672-056YZ	676-041	6	6.4	11.0	0.7	100	
	672-057	672-057ZP	672-057YZ	676-043	8	8.4	15.0	0.8	100	
	672-058	672-058ZP	672-058YZ	676-044	10	10.5	18.0	0.9	100	
	672-059	672-059ZP	672-059YZ	676-045	12	12.5	20.5	1.0	100	
	672-060	672-060ZP		676-046	14	14.5	24.0	1.0	100	
	672-061	672-061ZP		676-047	16	16.5	26.0	1.2	100	
	672-062	672-062ZP			18	19.0	30.0	1.4	100	
	672-063	672-063ZP		676-042	20	21.0	33.0	1.4	50	
	672-109ZP			22	23.0	36.0	1.5	50		
	672-064	672-064ZP		676-048	24	25.0	38.0	1.5	50	
	672-110				27	28.0	44.0	1.6	50	
	672-065	672-065ZP			30	31.0	48.0	1.6	50	
<p>DIN 6798J</p> <p>Carbon Steel</p> <p>Heat Treated</p>  <p>INTERNAL TOOTH</p>	672-066	672-066ZP	672-066YZ	676-F05-1M	2	2.2	4.5	0.3	100	
	672-067	672-067ZP	672-067YZ	676-053	2.5	2.7	5.5	0.4	100	
	672-111		672-111YZ		2.6	2.8	5.5	0.4	100	
	672-068	672-068ZP	672-068YZ	676-F02-1T	3	3.2	6.0	0.4	100	
	672-069	672-069ZP	672-069YZ	676-049	3.5	3.7	7.0	0.5	100	
	672-070	672-070ZP	672-070YZ	676-056	4	4.3	8.0	0.5	100	
	672-071	672-071ZP	672-071YZ	676-057	5	5.3	10.0	0.6	100	
	672-072	672-072ZP	672-072YZ	676-058	6	6.4	11.0	0.7	100	
	672-073	672-073ZP	672-073YZ	676-060	8	8.4	15.0	0.8	100	
	672-074	672-074ZP	672-074YZ	676-061	10	10.5	18.0	0.9	100	
	672-075	672-075ZP		676-062	12	12.5	20.5	1.0	100	
	672-076	672-076ZP		676-063	14	14.5	24.0	1.0	100	
	672-077	672-077ZP		676-064	16	16.5	26.0	1.2	100	
	672-078	672-078ZP			18	19.0	30.0	1.4	100	
672-079	672-079ZP		676-050	20	21.0	33.0	1.4	50		
672-113				22	23.0	36.0	1.5	50		
672-080	672-080ZP		676-051	24	25.0	38.0	1.5	50		
672-114				27	28.0	44.0	1.6	50		
672-081	672-081ZP			30	31.0	48.0	1.6	50		
<p>DIN 6798V</p> <p>EXTERNAL 90° COUNTERSUNK</p>  <p>Carbon Steel</p> <p>Heat Treated</p>	672-098				3	3.2	6.0	0.2	100	
	672-099				3.5	3.7	7.0	0.25	100	
	672-100		672-100YZ		4	4.3	8.0	0.25	100	
	672-101	672-101ZP			5	5.3	9.8	0.3	100	
	672-102	672-102ZP			6	6.4	11.8	0.4	100	
	672-103				8	8.4	15.3	0.4	100	
	672-104				10	10.5	19.0	0.5	100	
	672-K01-1C				12	13.0	23.0	0.5	100	
672-106				14	14.5	24.0	1.0	100		
672-107				16	16.5	26.0	1.2	100		

CATALOG 14

SPAENAUR

D

ASSORTMENT **805-437A**
ASSORTIMENT

Metric TOOTH LOCKWASHERS FLAT

STEEL,
Zinc Plated

24 VARIETIES
850 PIECES



Page
A78

DIN 6797A
EXTERNAL TOOTH
DIN 6797J
INTERNAL TOOTH

ASSORTMENT **805-470**
ASSORTIMENT

METRIC OVERLAP TOOTH LOCKWASHERS - FLAT

DIN 6798A
EXTERNAL TOOTH
DIN 6798J
INTERNAL TOOTH

A2
Stainless Steel

22 VARIETIES
760 PIECES



Page
A80

Furnished in a Regular Size grey enameled steel drawer, with hinged lid and scoop bins. Drawer will fit Slide Racks shown on page A2
Shipping Wt: **2.72 kg** (6 lbs.)

ASSORTMENT **805-451**
ASSORTIMENT

DIN 6797A **DIN 6797J**
EXTERNAL TOOTH INTERNAL TOOTH

METRIC TOOTH LOCKWASHERS - FLAT

A2 STAINLESS STEEL

24 VARIETIES - 850 PIECES

Shipping Wt. **2.95 kg** (6-1/2 lbs.)

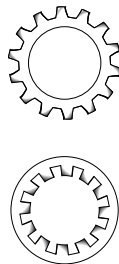

ASSORTMENT **805-438**
ASSORTIMENT

DIN 6798A **DIN 6798J**
EXTERNAL TOOTH INTERNAL TOOTH

METRIC OVERLAP TOOTH LOCKWASHERS - FLAT

SPRING STEEL, Zinc Plated

24 VARIETIES - 730 PIECES

Shipping Weight: **2.72 kg** (6 lbs.)



Furnished in a Regular Size grey enameled steel drawer with hinged lid and scoop bins.
Drawer will fit Slide Racks shown on page A2.



For the complete assortment contents turn to A79