

**Blind Rivets**

**Rivets aveugles**

**STANLEY**  
Engineered Fastening

**POP**<sup>®</sup>

Inch  
Pouce

**ALUMINUM  
Dome Head  
Open-end**

Covered by IFI Spec. 114

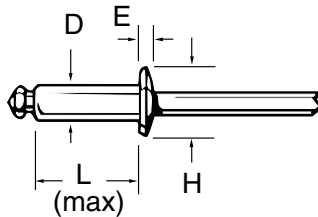

IFI Grade 19

PKG QTY. 500

**5056 Aluminum Body with  
Coated Carbon Steel Mandrel**

Break-stem - Mandrel head remains in rivet body.

\*Values shown are a guide only and may vary depending upon the application.

SPAENAUR No.	Mfr. No.	D RIVET BODY DIA.	HOLE SIZE & DRILL NO.	GRIP RANGE (Inches)	L LENGTH UNDER HD. (Max.)	H HEAD DIA. (Nom.)	E HEAD HEIGHT (Max.)	TYPICAL ULTIMATE STRENGTHS (lb)*	
								SHEAR	TENSILE
310-A16-1C 310-311	AD32BS AD34BS	3/32"	.097-.100 #41	.031-.125 .126-.250	.240 .365	.188	.032	125	175
310-326 310-A08-1W 310-A18-1T 310-A24-1X 310-304 310-305	AD41BS AD42BS AD43BS AD44BS AD45BS AD46BS	1/8"	.129-.133 #30	.031-.062 .063-.125 .126-.187 .188-.250 .251-.312 .313-.375	.203 .265 .328 .390 .453 .515	.250	.040	210	325
310-A13-1A 310-306	AD48BS AD410BS			.376-.500 .501-.625	.640 .765				
PR-70 PR-69 PR-67	AD52BS AD53BS AD54BS	5/32"	.160-.164 #20	.063-.125 .126-.187 .188-.250	.290 .353 .415	.312	.047	340	490
PR-64 310-308	AD56BS AD58BS			.251-.375 .376-.500	.540 .665				
PR-51 310-A17-1N PR-77	AD62BS AD64BS AD66BS	3/16"	.192-.196 #11	.063-.125 .126-.250 .251-.375	.315 .440 .565	.375	.055	445	720
PR-55 310-309 310-310	AD68BS AD610BS AD612BS			.376-.500 .501-.625 .626-.750	.690 .815 .940				
310-313 310-327	AD614BS AD616BS			.751-.875 .876-1.000	1.065 1.190				
PR-73 PR-74 PR-75	AD84BS AD86BS AD88BS	1/4"	.257-.261 F	.063-.250 .251-.375 .376-.500	.490 .615 .740	.500	.073	890	1200
310-328 PR-76 310-329	AD810BS AD812BS AD816BS			.501-.625 .626-.750 .751-1.000	.865 .990 1.240				

**ALUMINUM  
Large Flange Head  
Open-end**

Covered by IFI Spec. 114

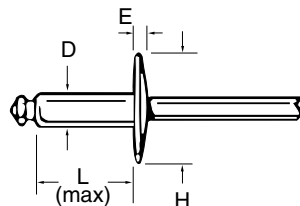

PKG QTY. 500

IFI Grade 19

**5056 Aluminum Body with  
Coated Carbon Steel Mandrel**

Break-stem - Mandrel head remains in rivet body.

310-330 310-331 310-307	AD42BSLF AD43BSLF AD44BSLF	1/8"	.129-.133 #30	.031-.125 .126-.187 .188-.250	.265 .328 .390	.375	.065	210	325
310-332	AD54BSLF	5/32"	.160-.164 #20	.126-.250	.415	.468	.075	340	490
310-333 310-334 310-316	AD64BSLF AD66BSLF AD68BSLF	3/16"	.192-.196 #11	.063-.250 .251-.375 .376-.500	.450 .565 .690	.625	.092	445	720
PR-68LF 310-335 310-336	AD610BSLF AD612BSLF AD616BSLF			.501-.625 .626-.750 .751-1.000	.815 .940 1.190				

Inch and Metric  
Pouce et Métrique

**STANLEY**  
Engineered Fastening

**POP**<sup>®</sup>

**Blind Rivets**  
Rivets aveugles

**ALUMINUM**  
**120° Countersunk Head**  
**Open-end**

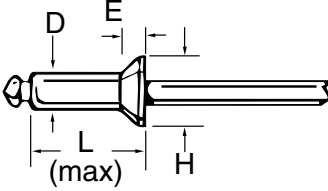

IFI Grade 19  
**5056 Aluminum Body with Coated Carbon Steel Mandrel**  
Break-stem - Mandrel head remains in rivet body.  
\*Values shown are a guide only and may vary depending upon the application.

Covered by IFI Spec.114

PKG QTY. 500

SPAENAUR No.	Mfr. No.	D RIVET BODY DIA.	HOLE SIZE & DRILL NO.	GRIP RANGE (Inches)	L LENGTH (Max.)	H HEAD DIA. (Nom.)	E HEAD HEIGHT (Max.)	TYPICAL ULTIMATE STRENGTHS (lb)*	
								SHEAR	TENSILE
310-A15-1Y	-	2.4 mm	2.5mm #41	2 - 5.6 mm	8.5 mm	4.7 mm	1.05 mm	400 N	550 N
PR-62	AK42BS	1/8"	.129-.133 #30	.063-.125	.265	.220	.030	210	325
310-395	AK43BS			.126-.187	.328	.220			
310-372	AK44BS			.188-.250	.390	.220			
PR-63	AK45BS			.251-.312	.453	.220			
310-373	AK54BS	5/32"	.160-.164 #20	.188-.250	.415	.281	.040	340	490
310-374	AK56BS			.251-.375	.540	.281			
310-394	TAPK512BS			.360-.422	.610	.312			
310-375	AK64BS	3/16"	.192-.196 #11	.126-.250	.440	.348	.050	445	720

**ALUMINUM**  
**Dome Head**  
**Open-end**

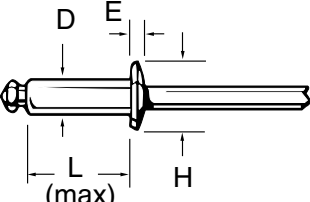

IFI Grade 11  
**5052 Aluminum Body with 7178 Aluminum Mandrel**  
Break-stem - Mandrel head remains in rivet body.

Covered by IFI Spec.114

PKG QTY. 500

310-383	AD32ABS	3/32"	.097-.100 #41	.031-.125	.240	.188	.032	85	135
PR-72	AD34ABS			.126-.250	.365				
310-337	AD36ABS			.251-.375	.490				
310-338	AD41ABS	1/8"	.129-.133 #30	.031-.062	.203	.250	.040	155	235
310-353	AD42ABS			.063-.125	.265				
310-A06-1T	AD43ABS			.126-.187	.328				
PR-66	AD44ABS			.188-.250	.390				
310-350	AD45ABS			.251-.312	.453				
310-351	AD46ABS			.313-.375	.515				
310-A05-1N	AD48ABS	5/32"	.160-.164 #20	.376-.500	.640	.312	.047	225	350
310-340	AD410ABS			.501-.625	.765				
310-354	AD52ABS			.063-.125	.290				
310-341	AD53ABS			.126-.187	.353				
310-355	AD54ABS			.188-.250	.415				
310-356	AD56ABS	3/16"	.192-.196 #11	.251-.375	.540	.375	.055	315	500
PR-79	AD58ABS			.376-.500	.665				
PR-56	AD62ABS			.063-.125	.315				
310-A12-1Y	AD64ABS			.126-.250	.440				
PR-58	AD66ABS	1/4"	.257-.261 F	.251-.375	.615	.500	.073	600	750
PR-59	AD68ABS			.376-.500	.690				
310-A03-1Y	AD610ABS			.501-.625	.815				
310-342	AD612ABS	3/16"	.192-.196 #11	.626-.750	.940	.375	.055	315	500
310-343	AD616ABS			.751-1.00	1.190				
310-344	AD84ABS	1/4"	.257-.261 F	.063-.250	.490	.500	.073	600	750
310-345	AD86ABS			.251-.375	.615				
310-346	AD812ABS			.501-.750	.990				

CATALOG 14  
SPAENAUR

**Blind Rivets**

**Rivets aveugles**

**STANLEY**  
Engineered Fastening

**POP**<sup>®</sup>

Inch  
Pouce

**ALUMINUM**  
**Large Flange Head**  
**Open-end**

Covered by IFI Spec.114

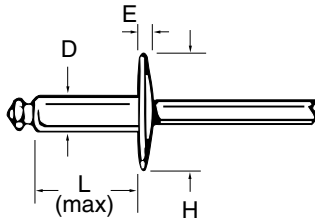

IFI Grade 11  
**5052 Aluminum Body with**  
**7178 Aluminum Mandrel**

Break-stem - Mandrel head remains in rivet body.

\*Values shown are a guide only and may vary depending upon the application.

PKG QTY. 500

SPAENAUR No.	Mfr. No.	D RIVET BODY DIA.	HOLE SIZE & DRILL NO.	GRIP RANGE (Inches)	L LENGTH (Max.)	H HEAD DIA. (Nom.)	E HEAD HEIGHT (Max.)	TYPICAL ULTIMATE STRENGTHS (lb)*		
								SHEAR	TENSILE	
310-352	AD42ABSLF	1/8"	.129-.133	.031-.125	.265	.375	.065	155	235	
310-347	AD44ABSLF		#30	.126-.250	.390					
310-348	AD54ABSLF	5/32"	.160-.164	.126-.250	.415	.468	.075	225	350	
310-349	AD64ABSLF	3/16"	.192-.196	#11	.063-.250	.625	.092	315	500	
310-A07-1K	AD66ABSLF				.251-.375					.565
310-385	AD68ABSLF				.376-.500					.690
310-357	AD610ABSLF				.501-.625					.815
310-358	AD612ABSLF				.626-.750					.940

**120° Countersunk Head**



310-376	AK42ABS	1/8"	.129-.133 #30	.063-.125	.265	.220	.030	155	235
---------	---------	------	---------------	-----------	------	------	------	-----	-----

**ALUMINUM**  
**Dome Head**  
**Open-end**

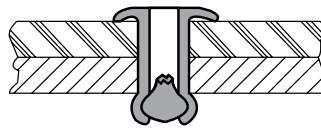

**Soft-Set Rivets**

For Fastening Plastics

Break-stem - Mandrel head remains in rivet body.

**1100 Aluminum Body with Aluminum Mandrel**

PKG QTY. 500

310-377	PAD41ABS	1/8"	.129-.133 #30	.126-.187	.031-.062	.250	.040	65	85	
310-317	PAD42ABS				.063-.125					.265
310-A14-1P	PAD43ABS				.126-.187					.328
310-319	PAD44ABS				.188-.250					.390
310-320	PAD46ABS				.251-.375					.515
310-321	PAD48ABS	.376-.500	.640							
310-322	PAD54ABS	5/32"	.160-.164 #20	.251-.375	.063-.250	.312	.047	105	145	
310-323	PAD56ABS				.251-.375					.540
310-324	PAD66ABS	3/16"	.192-.196 #11	.251-.375	.565	.375	.055	145	205	

**COPPER**  
**DOME HEAD**

Open-End

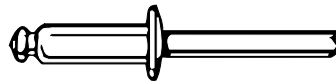

**Copper Body**  
**Coated Carbon Steel Mandrel**

Break-stem - Mandrel head remains in rivet body.

PKG QTY. 500

310-018	CD42BS	1/8"	.129-.133 #30	.126-.250	.265	.250	.040	215	300
310-054	CD44BS								

**Closed-End**



PR-110C	CD43H	1/8"	.129-.133 #30	.063-.187	.377	.236	.051	270	337
310-059	CD-45H								

**E20**

© 2018 Spenaaur Inc. All rights reserved. Catalog may not be reproduced, in whole or in part, without the written permission of Spenaaur Inc. Subject to Catalog Terms and Conditions of Use available at Spenaaur.com and on page TC2 and TC3 at the back of this catalog.  
© 2018 Spenaaur Inc. Tous droits réservés. Le catalogue ne peut être reproduit, en tout ou en partie, sans l'autorisation écrite de Spenaaur Inc. L'utilisation est soumise aux Conditions d'utilisation du Catalogue disponibles sur Spenaaur.com et à la page TC4 et TC5 à la fin de ce catalogue.

Inch  
Pouce

**STANLEY**  
Engineered Fastening

**POP**<sup>®</sup>

**Blind Rivets**  
Rivets aveugles

**ALUMINUM  
Dome Head  
Closed-End**

Hollow Core

IFI Grade 19  
**5056 Aluminum Body with  
Coated Carbon Steel Mandrel**

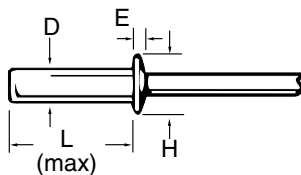

Break-stem  
Mandrel head remains in rivet body.

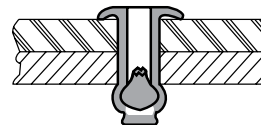

**Closed-End Sealing 'POP' Rivet**

This rivet type incorporates a unique cup-shaped end configuration that seals tight, preventing passage of vapor or liquid around or through the set rivet at pressures up to 500 psi.

PKG QTY. 500

\*Values shown are a guide only and may vary depending upon the application.

SPAENAUR No.	Mfr. No.	D RIVET BODY DIA.	HOLE SIZE & DRILL NO.	GRIP RANGE (Inches)	L LENGTH (Max.)	H HEAD DIA. (Nom.)	E HEAD HEIGHT (Max.)	TYPICAL ULTIMATE STRENGTHS (lb)*	
								SHEAR	TENSILE
PR-104 310-A11-1M PR-109	AD41H	1/8"	.129-.133 #30	.032-.062	.255	.236	.051	305	385
	AD42H			.063-.125	.316				
	AD43H			.126-.187	.377				
310-391 PR-100 310-359	AD44H	5/32"	.160-.164 #20	.188-.250	.440	.312	.066	430	605
	AD45H			.251-.312	.502				
	AD46H			.313-.375	.565				
310-360 PR-108 PR-107	AD48H	3/16"	.192-.196 #11	.376-.500	.690	.375	.081	575	840
	AD52H			.063-.125	.330				
	AD53H			.126-.187	.392				
310-392 PR-101	AD54H	1/4"	.257-.261 F	.188-.250	.435	.500	.099	900	1100
	AD55H			.188-.312	.517				
	AD62H			.063-.125	.345				
PR-105 PR-106 310-429	AD64H	5/32"	.126-.250	.126-.250	.470	.375	.081	575	840
	AD64SSH			.126-.250	.470				
	AD66H			.251-.375	.595				
310-380 310-361 310-362	AD68H	1/4"	.257-.261 F	.376-.500	.720	.500	.099	900	1100
	AD84H			.126-.250	.505				
	AD86H			.251-.375	.630				

**1100 Aluminum Body - with Aluminum Mandrel**

IFI Grade 15

310-386 310-363 310-364	AD42AH	1/8"	.129-.133 #30	.063-.125	.316	.236	.051	105	150
	AD43AH			.126-.187	.377				
	AD44AH			.188-.250	.440				
310-387	AD54AH	5/32"	.160-.164 #20	.063-.250	.455	.312	.066	155	240
310-388 310-382 310-389	AD62AH	3/16"	.192-.196 #11	.063-.125	.345	.375	.081	220	310
	AD64AH			.126-.250	.470				
	AD66AH			.251-.375	.595				
310-390	AD68AH			.376-.500	.720				

**ALUMINUM  
120° Countersunk  
Head  
Closed-End**

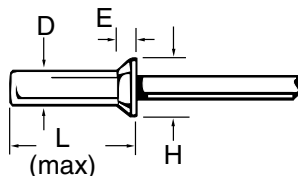

IFI Grade 19  
**5056 Aluminum Body with  
Coated Carbon Steel Mandrel**  
Break-stem - Mandrel head remains in rivet body.

PKG QTY. 500

310-365 310-A39-1Y 310-366	AK41H	1/8"	.129-.133 #30	.031-.062	.297	.233	.050	305	385
	AK42H			.063-.125	.361				
	AK43H			.126-.187	.422				
310-367 310-368	AK44H	5/32"	.160-.164 #20	.188-.250	.486	.312	.065	430	605
	AK45H			.251-.312	.548				
310-369 310-370 310-371	AK53H	3/16"	.192-.196 #11	.126-.187	.452	.375	.075	575	840
	AK64H			.126-.250	.540				
AK66H				.251-.375	.665				

CATALOG 14 SPAENAUR

# Pop® T-Rivets

THE STRONG, RELIABLE FASTENER  
THAT RESISTS VIBRATION

Designed for structural and similar high-strength applications, "Pop" T-Rivets have exceptional pull-up properties, and provide tensile strength up to 1100 pounds, and shear strength up to 2400 pounds. In setting, the hardened steel mandrel splits the aluminum body into a trifurcated shape that insures high clamping strength, even in thin or fragile materials.

Available in 3/16" and 1/4" rivet diameters with dome head.

For maximum performance of T-Rivets use SPAENAUR Power Rivet Tool **PRG-540** with **876-858** Nosepiece for 3/16" Dia. rivets or **876-859** Nosepiece for 1/4" Dia. rivets.



PKG QTY. 100

Aluminum (5056) RIVET with  
Plated Carbon Steel C-1038 Mandrel  
Dome Head - Open End

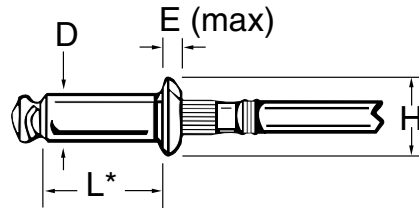
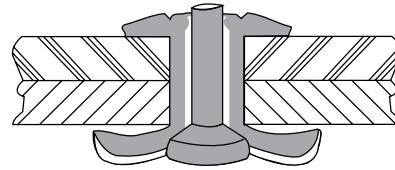

▪ Values shown are a guide only and may vary depending upon the application.

SPAENAUR No.	Mfr. No.	D RIVET BODY DIA.	HOLE SIZE & DRILL NO.	GRIP RANGE (Inches)	L* LENGTH UNDER HD. (Max.)	H HEAD DIA. (Nom.)	E HEAD HEIGHT (Max.)	TYPICAL ULTIMATE STRENGTHS (lb)▪	
								SHEAR	TENSILE
310-019	AD6140TFBS	3/16"	.192-.196 #11	.032-.140	.447	.390	.103	950	600
310-021	AD6250TFBS			.188-.250	.572			1050	
310-022	AD6312TFBS			.252-.312	.635			1100	
310-024	AD6437TFBS			.376-.437	.760			1275	
310-025	AD6519TFBS			.438-.519	.822			1350	
310-026	AD8140TFBS	1/4"	.257-.261	.032-.140	.500	.510	.126	1425	1100
310-027	AD8187TFBS			.141-.187	.552			1575	
310-028	AD8250TFBS			.188-.250	.615			1650	
310-030	AD8375TFBS			.313-.375	.740			2050	
310-031	AD8437TFBS			.376-.437	.802			2150	
310-032	AD8519TFBS			.438-.519	.865			2325	
310-033	AD8620TFBS			.520-.620	.937			2400	

\*To allow for blind side clearance ADD .125" for 3/16" diameter rivets and .165" for 1/4" diameter rivets.

E

Inch  
Pouce

**STANLEY**  
Engineered Fastening

**POP**<sup>®</sup>

**Blind Rivets**  
Rivets aveugles

# Multi-Grip Blind Rivet

## Dome Head

Functions in a wide range of material thicknesses.  
Break-stem - Mandrel head remains in rivet body.

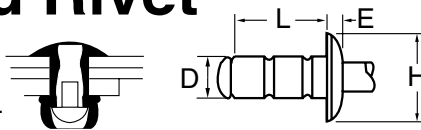

**Aluminum Body with  
Zinc Plated Steel Mandrel**

\*Values shown are a guide only and may vary depending upon the application.

Dimensions in Inches

SPAENAUR No.	Mfr. No.	D - RIVET BODY DIA.	HOLE SIZE	GRIP RANGE	L LENGTH	H HEAD DIA.	E HEAD HEIGHT	TYPICAL ULTIMATE STRENGTHS (lb)*	
								SHEAR	TENSILE
<b>310-A21-1K</b>	AD41-43BS	1/8"	.130-.142	.039-.189	.315	.252	.035	154	220
<b>310-411</b>	AD43-45BS	1/8"	.130-.142	.157-.315	.441	.252	.035	154	220
<b>310-412</b>	AD52-54BS	5/32"	.161-.173	.047-.252	.402	.315	.047	254	364
<b>310-413</b>	AD62-64BS	3/16"	.193-.205	.063-.252	.425	.378	.051	353	507
<b>310-414</b>	AD66-68BS	3/16"	.193-.205	.252-.504	.827	.378	.051	353	507

## 120° Countersunk Head

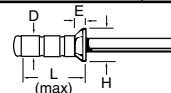
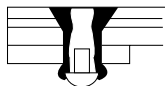

PKG QTY. 500

<b>310-415</b>	AK41-44BS	1/8"	.130-.142	.039-.252	.437	.217	.028	154	209
----------------	-----------	------	-----------	-----------	------	------	------	-----	-----

## Dome Head

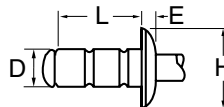
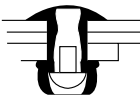

PKG QTY. 500

**Aluminum Body with  
Carbon Steel Mandrel**

<b>310-406</b>	AD45-47BS	1/8"	.130-.142	.251-.437	.594	.250	.036	154	220
<b>310-407</b>	AD53-55BS	5/32"	.161-.173	.126-.312	.485	.312	.043	254	364
<b>310-408</b>	AD68-612BS	3/16"	.193-.205	.437-.750	1.050	.375	.051	353	507

## Large Flange Head

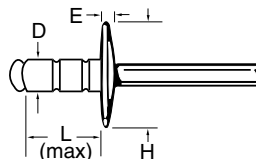
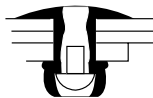

PKG QTY. 500

<b>310-409</b>	AD41-43BSLF	1/8"	.130-.142	.039-.189	.313	.375	.044	154	220
<b>310-416</b>	AD43-45BSLF	1/8"	.130-.142	.157-.315	.453	.375	.044	154	220
<b>310-417</b>	AD52-54BSLF	5/32"	.161-.173	.047-.252	.400	.468	.063	254	364
<b>310-419</b>	AD62-64BSLF	3/16"	.193-.205	.063-.252	.425	.625	.075	353	507
<b>310-420</b>	AD66-68BSLF	3/16"	.193-.205	.252-.504	.716	.625	.075	353	507

## Dome Head

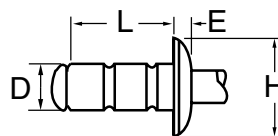
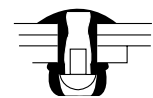

PKG QTY. 500

**Aluminum Body with  
Stainless Steel Mandrel**

<b>310-421</b>	AD62-64SSBS	3/16"	.193-.205	.062-.250	.425	.375	.051	353	507
----------------	-------------	-------	-----------	-----------	------	------	------	-----	-----

## 120° Countersunk Head

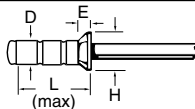
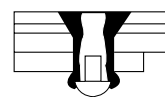

PKG QTY. 500

<b>310-422</b>	AK64-66SSBS	3/16"	.193-.205	.188-.375	.565	.348	.055	353	507
----------------	-------------	-------	-----------	-----------	------	------	------	-----	-----

## Large Flange Head

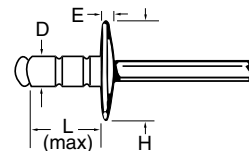

PKG QTY. 500

<b>310-423</b>	AD62-64SSBSLF	3/16"	.193-.205	.062-.250	.425	.625	.075	353	507
<b>310-425</b>	AD68-612SSBSLF	3/16"	.193-.205	.437-.750	1.050	.625	.075	353	507
<b>310-426</b>	AD68-612BSLF	.187"	.193-.205	.437-.750	1.05	.625	.083	350	505

PKG QTY. 500

CATALOG 14

SPAENAUR



**Blind Rivets**

**Rivets aveugles**

**STANLEY**  
Engineered Fastening

**POP**<sup>®</sup>

Inch

Pouce

**STEEL Dome Head Open-end**

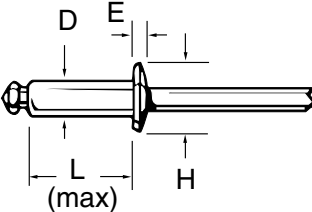

Covered by IFI Spec. 114

IFI Grade 30

**Plated Carbon Steel Body with Coated Carbon Steel Mandrel**

Break-Stem - Mandrel head remains in rivet body.

\*Values shown are a guide only and may vary depending upon the application.

PKG QTY. 500

SPAENAUR No.	Mfr. No.	D RIVET BODY DIA.	HOLE SIZE & DRILL NO.	GRIP RANGE (Inches)	L LENGTH UNDER HD. (Max.)	H HEAD DIA. (Nom.)	E HEAD HEIGHT (Max.)	TYPICAL ULTIMATE STRENGTHS (lb)*	
								SHEAR	TENSILE
310-004	SD32BS	3/32"	.097-.100 #41	.031-.125	.240	.188	.032	150	205
310-005	SD34BS			.126-.250	.365				
310-036	SD41BS	1/8"	.129-.133 #30	.031-.062	.203	.250	.040	295	425
PR-3	SD42BS			.063-.125	.265				
PR-1	SD43BS			.126-.187	.328				
PR-11	SD44BS			.188-.250	.390				
PR-14	SD45BS			.251-.312	.453				
PR-12	SD46BS	.313-.375	.515						
PR-13	SD48BS		.376-.500	.640					
310-037	SD53BS	5/32"	.160-.164 #20	.126-.187	.353	.312	.047	410	570
310-006	SD54BS			.188-.250	.415				
PR-15	SD56BS			.251-.375	.540				
310-035	SD62BS	3/16"	.192-.196 #11	.063-.125	.315	.375	.055	590	815
310-A22-1W	SD64BS			.126-.250	.440				
PR-6	SD66BS			.251-.375	.565				
PR-7	SD68BS			.376-.500	.690				
PR-17	SD610BS			.501-.625	.815				
310-038	SD612BS	.626-.750	.940						
310-039	SD614BS		.751-.875	1.065					
310-041	SD84BS	1/4"	.257-.261 F	.063-.250	.490	.500	.073	1245	1505
310-042	SD86BS			.251-.375	.615				
310-A04-1C	SD88BS			.376-.500	.740				
310-044	SD810BS			.501-.625	.865				
310-045	SD812BS			.626-.750	.990				
310-046	SD816BS			.876-1.000	1.240				

**POP RIVET Body Only**

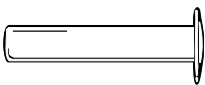

Steel Zinc Plated

PKG QTY. 500

87551	-	1/8	-	-	.640	-	-	-	-
-------	---	-----	---	---	------	---	---	---	---

**STEEL Large Flange Head Open-end**

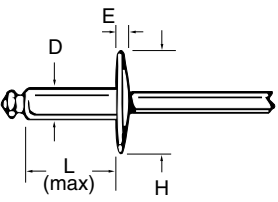

Covered by IFI Spec. 114

IFI Grade 30

**Plated Carbon Steel Body with Coated Carbon Steel Mandrel**

Break-stem - Mandrel head remains in rivet body.

PKG QTY. 500

310-047	SD42BSLF	1/8"	.129-.133 #30	.063-.125	.265	.375	.065	295	425
310-048	SD44BSLF			.126-.250	.390				
310-049	SD54BSLF	5/32"	.160-.164 #20	.126-.250	.415	.468	.075	410	570
310-427	SD56BSLF			.251-.375	.540				
310-050	SD64BSLF	3/16"	.192-.196 #11	.063-.250	.440	.625	.092	590	815
PR-16LF	SD66BSLF			.251-.375	.565				
310-051	SD68BSLF			.376-.500	.690				
310-007	SD610BSLF			.501-.625	.815				
310-052	SD612BSLF			.626-.750	.940				

Inch  
Pouce

**STANLEY**  
Engineered Fastening

**POP**<sup>®</sup>

**Blind Rivets**

**Rivets aveugles**

**STEEL** PKG QTY. 500

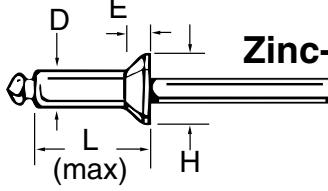
**120° Countersunk Head**  **Zinc-Plated Carbon Steel Body with Coated Carbon Steel Mandrel**

**Open-end**

Break-stem - Mandrel remains in rivet body.  
\*Values shown are a guide only and may vary depending upon the application.

Covered by IFI Spec. 114

SPAENAUR No.	Mfr. No.	D RIVET BODY DIA.	HOLE SIZE & DRILL NO.	GRIP RANGE (Inches)	L LENGTH (Max.)	H HEAD DIA. (Nom.)	E HEAD HEIGHT (Max.)	TYPICAL ULTIMATE STRENGTHS (lb)*	
								SHEAR	TENSILE
310-A20-1T	SK42BS	1/8"	.129-.133 #30	.063-.125	.265	.220	.045	295	425
PR-2	SK43BS			.126-.187	.328				
310-053	SK44BS			.126-.250	.390				

**MONEL** PKG QTY. 500

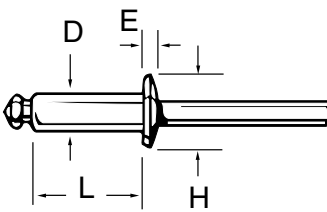
**Dome Head**  **Monel Body with Coated Carbon Steel Mandrel**

**Open-end**

IFI Grade 40  
Break-stem - Mandrel head remains in rivet body.

Covered by IFI Spec. 114

310-381	MD424BS	1/8"	.129-.133 #30	.071-.120	.240	.236	.041	440	565
PR-128	MD429BS			.121-.170	.290				
PR-129	MD440BS			.231-.280	.400				

**Nickel-Copper Alloy Body with Carbon Steel Mandrel**

116184	MD530BS	5/32"	.150-.164 #20	.101-.160"	.305"	.263	.040	495	674
310-A19-1K	MD537BS	5/32"	.160-.164 #20	.161-.230	.395	.263	.040	495	674
116185	MD540BS			.231-.260	.405				
116186	MD545BS			.261-.310	.453				
PR-132	MD636BS	3/16"	.192-.196 #11	.151-.200	.385	.320	.055	742	843
PR-126	MD639BS			.201-.230	.415				
PR-127	MD650BS			.231-.340	.525				
310-900	MD665BS	1/4"	.257-.261 F	.341-.490	.675	.427	.068	1214	1517
PR-133	MD675BS			.491-.590	.775				
310-901	MD850BS			.151-.300	.525				
PR-134	MD870BS	.301-.500	.725						

**120° Countersunk Head** PKG QTY. 500

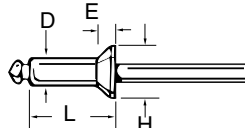
**Open-end**  **Nickel-Copper Alloy Body with Carbon Steel Mandrel**

Break-stem - Mandrel head remains in rivet body.

310-904	MK429BS	1/8"	.129-.133 #30	.151-.200	.346	.257	.036	337	427
310-902	MK440BS			.261-.310	.456				
310-903	MK530BS	5/32"	.160-.164 #20	.131-.190	.359	.263	.039	495	674
310-057	TLPK665BS	3/16"	.192-.196 #11	.371-.520	.709	.320	.045	742	843
310-058	TLPK675BS			.521-.620	.807				

CATALOG 14

SPAENAUR



Blind Rivets

Rivets aveugles

**STANLEY**  
Engineered Fastening

**POP**<sup>®</sup>

Inch

Pouce

PKG QTY. 500

300 Series

**STAINLESS STEEL**

IFI Grade 50

**300 Series Stainless Steel Body with Coated Carbon Steel Mandrel**

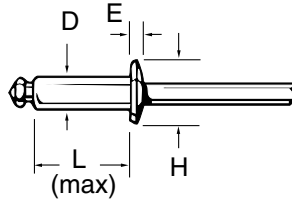

Break-stem - Mandrel head remains in rivet body.

\*Values shown are a guide only and may vary depending on the application.

**Dome Head Open-end**

SPAENAUR No.	Mfr. No.	D RIVET BODY DIA.	HOLE SIZE & DRILL NO.	GRIP RANGE (Inches)	L LENGHT UNDER HD. (Max.)	H HEAD DIA. (Nom.)	E HEAD HEIGHT (Max.)	TYPICAL ULTIMATE STRENGTHS (lb)*	
								SHEAR	TENSILE
310-835	SSD41BS	1/8"	.129-.133 #30	.031-.062	.203	.250	.040	550	700
310-800	SSD42BS			.063-.125	.265				
310-801	SSD43BS			.126-.187	.328				
310-802	SSD44BS			.188-.250	.390				
310-803	SSD46BS			.251-.375	.515				
310-836	SSD48BS			.376-.500	.640				
310-809	SSD52BS	5/32"	.160-.164 #20	.063-.125	.290	.312	.047	900	1130
310-810	SSD54BS			.126-.250	.415				
310-807	SSD56BS			.251-.375	.540				
310-806	SSD62BS	3/16"	.192-.196 #11	.063-.125	.315	.375	.055	1000	1375
310-804	SSD64BS			.126-.250	.440				
310-A01-1A	SSD66BS			.251-.375	.565				
310-808	SSD68BS			.376-.500	.690				

**300 Series Stainless Steel Body with Stainless Steel Mandrel**

310-A10-1W	SSD42SSBS	1/8"	.129-.133 #30	.063-.125	.265	.250	.040	550	700
310-A23-1M	SSD43SSBS			.126-.187	.328				
310-A09-1M	SSD44SSBS			.188-.250	.390				
310-823	SSD46SSBS			.251-.375	.515				
310-A02-1P	SSD48SSBS			.376-.500	.640				
310-827	SSD52SSBS	5/32"	.160-.164 #20	.063-.125	.290	.312	.047	900	1130
310-840	SSD53SSH			.126-.187	.392				
310-828	SSD54SSBS			.126-.250	.415				
310-829	SSD56SSBS			.251-.375	.540				
310-830	SSD62SSBS	3/16"	.192-.196 #11	.063-.125	.315	.375	.055	1000	1375
310-841	SSD62SSH			.032-.125	.353				
310-824	SSD64SSBS			.125-.250	.425				
310-842	SSD64SSH			.126-.250	.477				
310-825	SSD66SSBS			.251-.375	.565				
310-831	SSD68SSBS			.376-.500	.690				

300 Series

**STAINLESS STEEL**  
Large Flange Head  
Open-end

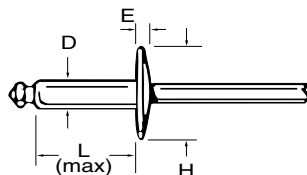

IFI Grade 50

**300 Series Stainless Steel Body with Coated Carbon Steel Mandrel**

Break-stem - Mandrel remains in rivet body.

PKG QTY. 500

310-837	SSD42BSLF	1/8"	.129-.133 #30	.031-.125	.265	.375	.065	550	700
310-838	SSD43BSLF			.126-.187	.328				
310-839	SSD44BSLF			.188-.250	.390				

**300 Series Stainless Steel Body with Stainless Steel Mandrel**

310-832	SSD42SSBSLF	1/8"	.129-.133 #30	.031-.125	.265	.375	.065	550	700
310-833	SSD43SSBSLF			.126-.187	.328				
310-834	SSD44SSBSLF			.188-.250	.390				

Inch  
Pouce

**STANLEY**  
Engineered Fastening

**POP®**

**Blind Rivets / Blind Rivet Plugs**  
Rivets aveugles / Capuchons pour rivets aveugles

**The POP® UltraGrip Rivet – Set it. Forget it.**

PKG QTY. 500

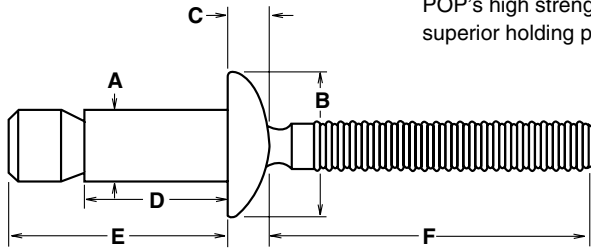

POP's high strength UltraGrip rivets with a positive mechanical locking system provide superior holding power over other high strength rivets. This system also guarantees 100% mandrel retention that's visually verifiable. The locking feature seals the mandrel head into the body preventing head drop-out and keeps the application free of contamination from metal fragments.

UltraGrip high strength rivets provide a wide grip range that allows one rivet size to handle several applications, reducing the amount of parts in inventory. Ultra-Grip rivets are available in 3/16" and 1/4" diameter with grip ranges up to 5/8".

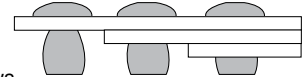

**Dome Head Style**

ORDER BY SPAENAUR NUMBERS LISTED BELOW

Diameter	ORDER BY SPAENAUR NUMBERS LISTED BELOW			Grip Range	Hole Size	Fastener Dimensions					
	Steel Body & Mandrel	Aluminum Body & Mandrel	Stainless Steel Body & Mandrel			A	B	C	D	E	F
3/16"		301-360	301-800	.062-.270"	.191-.201"	.183"	.385"	.085"	.415"	.675"	1.00"
		301-362	—	.062-.437"							
1/4"	301-443		301-801	.080-.375"	.261-.272"	.253"	.525"	.117"	.560"	.970"	1.00"
			301-802	.080-.625"							

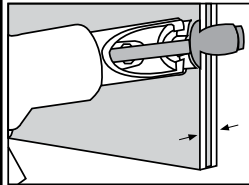

After inserting an UltraGrip rivet with its "easy entry" chamfered head into the prepared hole, the POP Rivetool engages the mandrel pulling it into the rivet body.

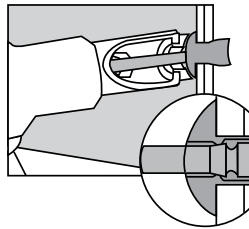

As the mandrel head recedes into the rivet body it draws the materials together and forms an expanded head on the blind side. The positive mechanical lock is formed when the rivet body's internal locking ring seats itself in the mandrel's groove.

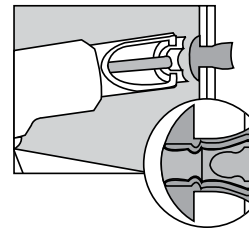

The POP Rivetool continues to pull, breaking the mandrel flush and completing installation. There is no need for grinding or other smoothing operations. Visual inspection verifies that the rivet is fully set and that the mandrel head is locked in place.

**Typical Installed Values in Nominal Grip - Pounds / Material and Finish Specifications.**

Material	Dia.	Shear	Tensile	Pin Push-Out	Material Specifications		Finish Specifications	
					Body	Mandrel	Body	Mandrel
Steel	3/16"	1400	1100	150	AISI 1006	AISI 10B22	Zinc Plated with Clear Chro. Fin.	Gold Finish
	1/4"	2500	2150	300	(Steel)	(Steel)		
Aluminum	3/16"	700	500	50	5056	7075	Clear Chromate	Gold Chromate
	1/4"	1300	890	100	(Aluminum)	(Aluminum)		
Stainless	3/16"	1400	1000	125	AISI 302	AISI 305	No Plate	No Plate
	1/4"	2500	2000	250	(Stainless Steel)	(Stainless Steel)		

**Aluminum Mushroom Plugs for use with 3/16" Dia. Pop® Rivets**

SPAENAUR No.	A Tapered End Diameter	D Head Diameter	E Stem Diameter	PKG QTY.
310-060	.108"	.432"	.1195"	500

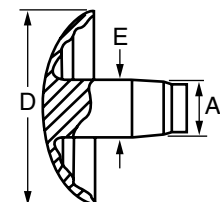

CATALOG 14 SPAENAUR