

Socket Adapter / Ratchets / Extensions / Drive Tool

Adaptateur de douille / Clés à rochet / Rallonges / Outil d'entraînement



Inch and Metric
Pouce et Métrique

Socket Adapter

DIN 3123, ISO 3316

1/4 inch 3/8 inch

Chrome-Plated Chrome-Vanadium

- 3/8" ■, 1/4" □,
- drive nominal size 6.3 = 1/4"
- drive nominal size 10 = 3/8"



SPAENAUR No.	HAZET No.	■ inch	□	L mm
991-208	858-1	3/8	1/4	26.5

Spin Type Speeder

DIN 3122, ISO 3315

Chrome-Vanadium

Chrome-Plated

- 1/4" ■,
- With trinamic®-handle, black (protected by design patent)



SPAENAUR No.	HAZET No.	mm	L inch
991-217	866	134	5-1/4

Reversible Ratchets

DIN 3122, ISO 3315

Chrome-Vanadium

1/4" ■,



With HAZET ergonomic® plastic handle, black (protected by design patent), 20 teeth.

Chrome-Plated Polished

SPAENAUR No.	HAZET No.	mm	L inch
991-210	863 P	115	4-1/2

Extensions

DIN 3123, ISO 3316

Chrome-Vanadium

- 1/4" ■, 1/4" □ drive,
- drive nominal size 6.3 = 1/4"
- drive nominal size 6.3 = 1/4"



SPAENAUR No.	HAZET No.	mm	L inch
991-218	867-2	55	2
991-219	867-4	100	4

Reversible Ratchets

With hinge joint

Chrome-Vanadium

1/4" ■,

With HAZET ergonomic® plastic handle, black (protected by design patent), 20 teeth.

Chrome-Plated Polished



SPAENAUR No.	HAZET No.	mm	L inch
991-212	863 G	135	5-5/16

DIN 3123, ISO 3316



991-220	868	147	5-3/4"
---------	-----	-----	--------

Universal Joint

DIN 3123, ISO 3316

Chrome-Vanadium

1/4" ■, 1/4" □ drive,

Chrome-Plated



SPAENAUR No.	HAZET No.	mm	L inch
991-221	869	36.5	1-7/16"

Flexible Handle

DIN 3122, ISO 3315

Chrome-Vanadium

1/4" ■,

Chrome-Plated

With HAZET ergonomic® plastic handle, black (protected by design patent),



SPAENAUR No.	HAZET No.	mm	L inch
991-215	864	143	5-5/8

N

Inch and **Metric**
Pouce et **Métrique**



Socket Sets / Extensions / Adapters / 6 Point Socket
Ensembles de douilles / Rallonges / Adaptateurs / Douille à 6 pointes

1/4
inch



SPAENAUR No. 991-229
(HAZET No. 854)

-with Screwdriver Bits-

30 parts

SPAENAUR No's.

	991-210
	991-216
	991-217
	991-218
	991-220
	991-221

187 x 125 x 39 mm

6 Point Sockets				Hex Bits		Torx Bits		
SPAENAUR No.	Sizes	SPAENAUR No.	Sizes	SPAENAUR No.	Sizes	SPAENAUR No.	Sizes	
991-142	4	991-149	9	991-183	3	991-201	1	
991-144	5	991-150	10	991-184	4	991-202	2	
991-145	5.5	991-151	11	991-185	5	Torx Bits		
991-146	6	991-152	12	991-186	6		991-205	1
991-147	7	991-153	13	991-187	8		991-206	2
991-148	8	991-154	14					

Extensions

DIN 3123, ISO 3316
Chrome-Vanadium
1" ■, 1" □, drive
■ with locking device,
□ with bolt for locking device

1
inch

**Chrome-Plated
Polished**

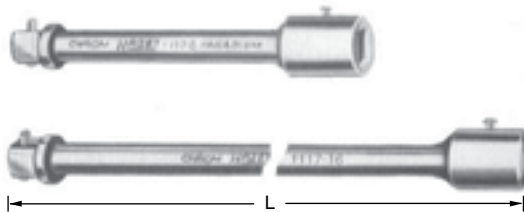

SPAENAUR No.	HAZET No.	L		Ø
		mm	inch	
991-876	1117-8	200	8	28
991-877	1117-16	400	16	28

Universal Joint

Chrome-Vanadium
1" ■, 1" □, drive (DIN 3120)
■ with locking device,
□ with bolt for locking device

1
inch

Chrome-Plated



SPAENAUR No.	HAZET No.	L		Ø
		mm	inch	
991-878	1121	143	5-3/4	48

Adapter

DIN 3123, ISO 3316
Chrome-Vanadium
1" □ drive,
■ with ball fitting and locking device,
□ with bolt for locking device



SPAENAUR No.	HAZET No.	L mm	inch	
			■	□
991-879	1158-2	70	3/4	1

6 Point Spark Plug Sockets

Foreign patents
Chrome-Vanadium
3/8" □ drive (DIN 3120)

3/8
inch

**Chrome-Plated
Polished**



SPAENAUR No. 993-978
Replacement Magnet for 991-372

SPAENAUR No. 993-977
Replacement Magnet for 991-373

Long pattern, with permanent magnet and guide bushing
Centres all plugs automatically.



SPAENAUR No.	HAZET No.	s		L mm	d ₁ mm	d ₂ mm	t mm
		mm	inch				
991-372	880 Mg T	20.8	13/16	64	27.4	22.5	9.0
991-373	880 A Mg T	16.0	5/8	64	21.6	21.7	9.0

Inch and Metric
Pouce et Métrique



Breaker Bars / Ratchets / Extensions
Poignées articulées / Clés à rochet / Rallonges

Flexible Handle - Power Bar

DIN 3122, ISO 3315

Chrome-Vanadium

3/8" ■ drive,

with HAZET-ergonomic® plastic handle, black (protected by design patent)



Chrome-Plated
Polished

SPAENAUR No.	HAZET No.	L	
		mm	inch
991-421	8814	250	10

Reversible Ratchet

Chrome-Vanadium

3/8" ■ drive (DIN 3120),

with 30 teeth, with HAZET-ergonomic® plastic handle, black (protected by design patent),

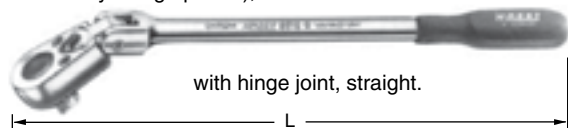

Chrome-Plated
Polished

SPAENAUR No.	HAZET No.	L	
		mm	inch
991-424	8816 G	276	11

Reversible Ratchet

Din 3122, ISO 3315

Chrome-Vanadium

3/8" ■ drive,

with 30 teeth, with HAZET -ergonomic® plastic handle, black (protected by design patent)



Chrome-Plated
Polished

SPAENAUR No.	HAZET No.	L	
		mm	inch
991-428	8816 P	200	7-3/4

Flexible Extension

Chrome-Vanadium

3/8" ■, 3/8" □ drive (DIN 3120)

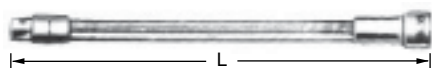

Chrome-Plated
Polished
Shaft Burnished

SPAENAUR No.	HAZET No.	L	
		mm	inch
991-438	8830	210	8-1/4

Socket Adapters

DIN 3123, ISO 3316

Chrome-Vanadium

3/8" □ drive

Chrome-Plated



SPAENAUR No.	HAZET No.	L mm	■	□
			inch	inch
991-439	8858-1	36	1/2	3/8
991-440	8858-2	26	1/4	3/8

Universal Joint

DIN 3123, ISO 3316

Chrome-Vanadium

3/8" ■, 3/8" □

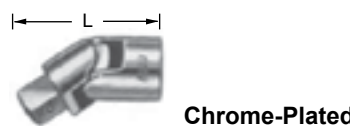

Chrome-Plated

SPAENAUR No.	HAZET No.	L	
		mm	inch
991-429	8820	46.5	2

Sliding T-Handle

DIN 3122, ISO 3315

Chrome-Vanadium

3/8" ■ drive



Chrome-Plated
Polished

SPAENAUR No.	HAZET No.	L	
		mm	inch
991-422	8815	198	7-3/4

Extensions

DIN 3123, ISO 3316

Chrome-Vanadium

3/8" ■, 3/8" □ drive



Chrome-Plated
Polished

SPAENAUR No.	HAZET No.	L	
		mm	inch
991-430	8821-3	74	3
991-431	8821-5	126	5
*991-432	8821-6	150	6
*991-433	8821-8	202	7-3/4
991-434	8821-10	254	10
*991-435	8821-12	304	12
*991-436	8821-20	508	20
*991-437	8821-28	711	28

*not according to DIN

Inch and Metric
Pouce et Métrique



Ratchet / Extensions / Adapters
Clés à rochet / Rallonges / Adaptateurs

Reversible Ratchet

DIN 3122, ISO 3315

Chrome-Vanadium

1/2" ■ drive,
with HAZET-ergonomic®
plastic handle, black
(protected by design patent)

**Chrome-Plated
Polished**
32 teeth



SPAENAUR No.	HAZET No.	mm	L inch
991-634	916 SP	275	10-3/4

*Replacement Plastic Handle
for 991-630 and 991-634*
SPAENAUR No. 993-310
(HAZET No. 916 KG-02)

Socket Adapters

DIN 3123, ISO 3316

Chrome-Vanadium

1/2" □ drive

Chrome-Plated



991-640



991-641

SPAENAUR No.	HAZET No.	L mm	■ inch	□ inch
991-640	958-1	50	3/4	1/2
991-641	958-2	36	3/8	1/2

Extensions

DIN 3123, ISO 3316

Chrome-Vanadium

1/2" ■, 1/2" □ drive

**Chrome-Plated
Polished**

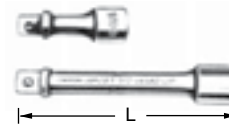

SPAENAUR No.	HAZET No.	mm	L inch
991-635	917-3	76	3
991-636	917-5	123	5



Long Pattern

991-637	918-10	248	9-3/4
991-638	918-23	575	22-1/2

Universal Joint

DIN 3123, ISO 3316

Chrome-Vanadium

1/2" ■, 1/2" □ drive

Chrome-Plated



SPAENAUR No.	HAZET No.	mm	L inch
991-639	920	70	2-3/4

Wobble Extension

With ball shaped, conical
outside square drive -
allows 12.5° angular
movement to every side.

For working on fasteners
in constricted areas.

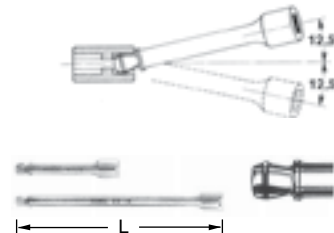

SPAENAUR No.	HAZET No.	mm	L inch
993-802	919-5	123	4-7/8
993-803	919-10	248	9-3/4

Ratchet / Adapters / 12 Point Sockets / Extensions

Clé à rochet / Adaptateurs / Douilles à 12 pointes / Rallonges



Inch and Metric
Pouce et Métrique

Ratchet Head

Chrome-Vanadium
3/4" ■ (DIN 3120),
■ with ball fitting and locking device,
shank with bolt for locking device
32 teeth



Chrome-Plated

SPAENAUR No.	HAZET No.	L		Ø mm
		mm	inch	
991-835	1016	165	6-1/2	—

Extensions

Chrome-Vanadium
3/4" ■, 3/4" □ drive,
■ with ball fitting and locking device
□ with bolt for locking device

Chrome-Plated
Polished

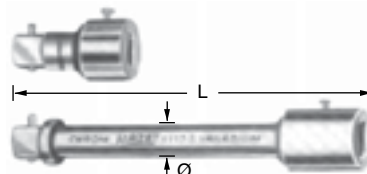

SPAENAUR No.	HAZET No.	L		Ø mm
		mm	inch	
*991-837	1017-3	75	3	25
991-838	1017-8	200	8	20

*not according to DIN
991-838 = DIN 3123, ISO 3316

Adapters

DIN 3123, ISO 3316
Chrome-Vanadium
3/4" □ drive
with ball fitting and locking device



Chrome-Plated

SPAENAUR No.	HAZET No.	L mm	inch	
			■	□
991-841	1058-1	60	1	3/4
991-842	1058-2	52.3	1/2	3/4

DIN 3123, ISO 3316



991-839	1018	400	16	22
---------	------	-----	----	----

12 Point Sockets

Chrome-Vanadium
For injection nozzles on diesel engines
VW-Audi, Mercedes-Benz, Opel, Ford,
Peugeot-Talbot, Volvo, Toyota, Mazda,
Nissan, Mitsubishi, Daihatsu,
MB-No. 001 589 65 09 00

For turning the engine over at
the crankshaft hex head screws.
With special relief-turned
section of accommodate
the small leakage return tubes.

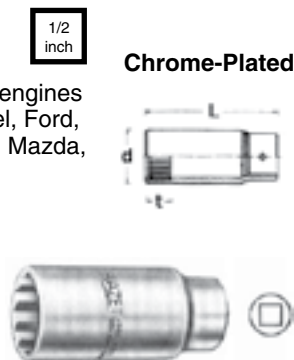

Chrome-Plated

SPAENAUR No.	HAZET No.	s mm	L mm	d mm	t mm
992-908	4555	27	82	36.2	15

Crown Wrench

Chrome-Vanadium
For tightening and slackening
the nozzle holder nuts
in Mercedes-Benz trucks
M 401/421, M 402/422, LA,A,
M 403/423, M 470 h,
MB-No. 403 589 04 07 00

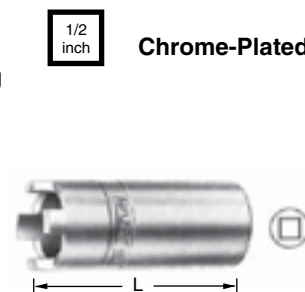

Chrome-Plated

SPAENAUR No.	HAZET No.	L mm
992-912	4558	72

For injection nozzles on
BMW-Diesel 524 td,
Ford-Diesel Lincoln
Continental (USA),
Lincoln Mark VII, VII LSC



992-909	4555-1	20	82	36.2	15
---------	--------	----	----	------	----

N

Impact Adapters / Extensions / 6 Point Impact Sockets

Adaptateurs de clé à choc / Rallonges / Douilles de clé à chocs à 6 points



Inch and Metric
Pouce et Métrique

Impact Adapter

To hold impact sockets for use on electric and pneumatic drills, with 1/4" □ drive

1/4 inch

6,3
DIN 3121
(1/4")



E 6,3
DIN 3126,
Form E
(1/4")



SPAENAUR No.	HAZET No.	L		L mm
		mm	inch	
991-900	8508 S-3	6.3	1/4	50

Adapter

To hold impact sockets for application on electric and pneumatic drills, with 3/8" □ drive,

10
DIN 3121
(3/8")

5/16"



SPAENAUR No.	HAZET No.	L		L mm
		mm	inch	
991-930	8808 S-1	10	3/8	75

Impact Extensions

3/8" ■, 3/8" □ drive (DIN 3121)

3/8 inch

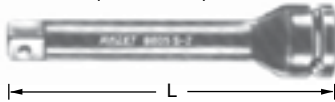

SPAENAUR No.	HAZET No.	L		inch
		mm	inch	
991-926	8805 S-6	152	6	3/8

1/2" Drive 6 Point Impact Sockets Long Pattern

1/2" □ drive
□ DIN 3121,
6 point DIN 475

1/2 inch



SPAENAUR No.	HAZET No.	mm	L mm	d ₁ mm	d ₂ mm	t mm
991-953	900 S Lg-13	13	85	20.8	25	8.5
991-954	900 S Lg-16	16	85	24.8	30	13.5
991-955	900 S Lg-17	17	85	26.2	30	13.5
991-956	900 S Lg-18	18	85	28.5	30	17.5
991-957	900 S Lg-19	19	85	28.8	30	17.5
▲ 991-958	900 S Lg-21	21	85	31.3	30	15.5
991-959	900 S Lg-22	22	85	32.5	30	17.5
991-960	900 S Lg-24	24	85	35.0	30	17.5
991-961	900 S Lg-27	27	85	38.8	30	19.5

▲ For wheel nuts/screws

Impact Adapters

3/4" □ drive

3/4 inch



992-022



992-023

SPAENAUR No.	HAZET No.	inch	inch	L mm
992-022	1007 S-1	1/2	3/4	56
992-023	1007 S-2	1	3/4	65