

**Extruded Channels**

Inch

**Profils extrudés**



Pouce

**Material:** EPDM, Santoprene®, SBR, Neoprene, PVC, Vinyl, etc., as indicated.

(Please refer to "Elastomer Compound Characteristics" — page R19.)

**Hardness:** Durometer shown under profile and No., subject to ±5.

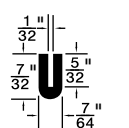
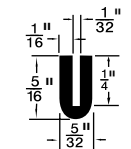
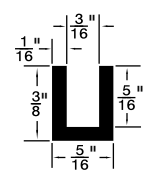
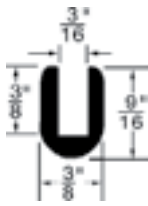
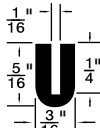
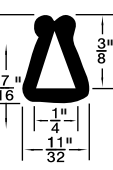
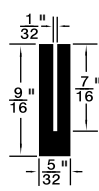
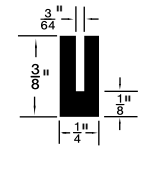
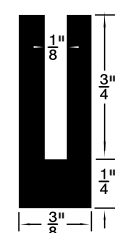
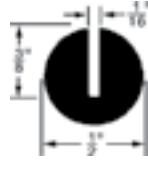
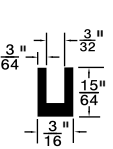
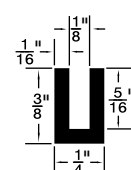
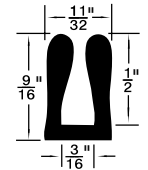
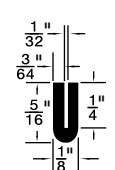
**Colour:** Black.

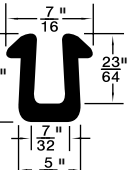
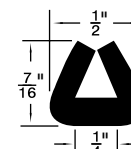
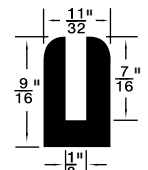
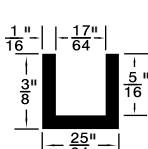
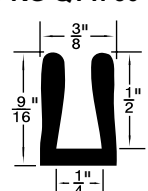
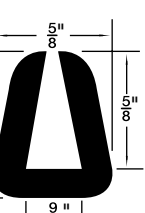
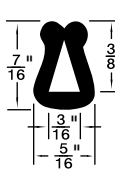
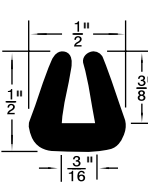
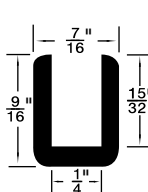
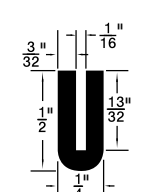
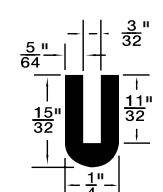
 <p><b>825-B19-1W</b> EPDM Duro 70 PKG QTY. 100</p>	 <p><b>825-B28-1N</b> EPDM Duro 70 PKG QTY. 100</p>	 <p><b>4511-A</b> EPDM Duro 70 PKG QTY. 50</p>	 <p><b>825-229</b> EPDM Duro 50 PKG QTY. 50</p>	 <p><b>825-B13-2P</b> EPDM Duro 65-75  <b>825-B07-1A</b> Neoprene Duro 70 PKG QTY. 50</p>
 <p><b>4517</b> SBR Duro 50 PKG QTY. 50</p>	 <p><b>RW-45</b> SBR Duro 65 PKG QTY. 200</p>	 <p><b>825-B39-1C</b> SBR Duro 70 PKG QTY. 100</p>	 <p><b>825-042</b> Neoprene Duro 60 PKG QTY. 50</p>	 <p><b>825-227</b> Neoprene Duro 60 PKG QTY. 50</p>
 <p><b>825-B36-1A</b> SBR Duro 70 PKG QTY. 100</p>	 <p><b>825-B14-1Y</b> SBR Duro 70 PKG QTY. 50</p>	 <p><b>4514</b> SBR Duro 70 PKG QTY. 50</p>	 <p><b>RW-102</b> SBR Duro 70 PKG QTY. 100</p>	 <p><b>825-228</b> Neoprene Duro 55 PKG QTY. 50</p>
 <p><b>RW-40</b> SBR Duro 70 PKG QTY. 100</p>	 <p><b>825-B38-1Y</b> SBR Duro 70 PKG QTY. 50</p>	 <p><b>RW-35</b> SBR Duro 70 PKG QTY. 50</p>	 <p><b>RW-44</b> SBR Duro 70 PKG QTY. 100</p>	 <p><b>825-B22-1M</b> Santoprene® Duro 70 PKG QTY. 50</p>
 <p><b>C-19</b> SBR Duro 70 PKG QTY. 4 Lengths (11'-6")</p>	 <p><b>4516</b> SBR Duro 70 PKG QTY. 50</p>	 <p><b>825-B05-1N</b> SBR Duro 70 PKG QTY. 50</p>	 <p><b>4588</b> SBR Duro 70 PKG QTY. 50</p>	 <p><b>825-B06-2X</b> Santoprene® Duro 70 PKG QTY. 100</p>
				 <p><b>825-B20-1K</b> Santoprene® Duro 70 PKG QTY. 100</p>

Continued on Next Page

CATALOG 14

SPAENAUR

Inch

**Extruded Channels & Weatherstrips**

Pouce

**Profilés et bourrelets d'étanchéité extrudés**

...Continued from previous page.

Colour: Black, unless otherwise indicated.

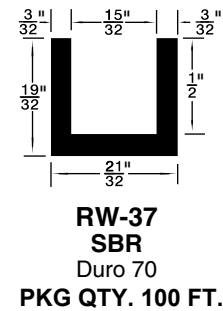
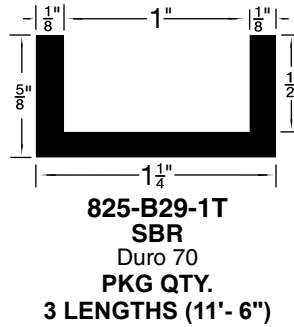
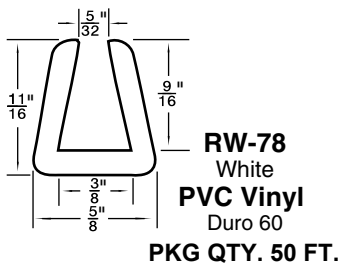
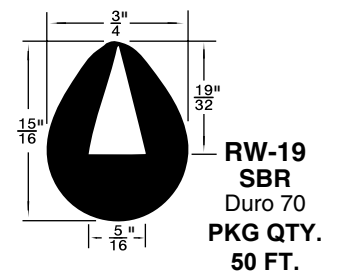
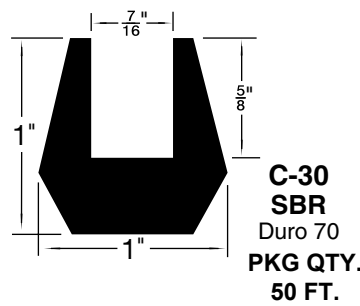
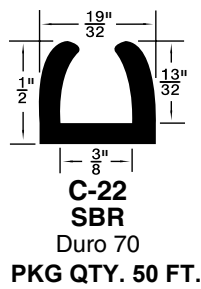
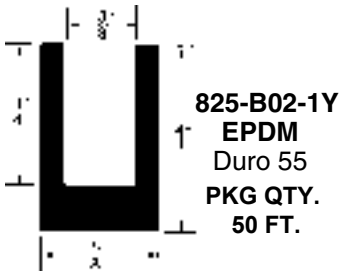

**ONE PIECE SELF-SEALING WEATHERSTRIPS**

Material: EPDM, or SBR as indicated.

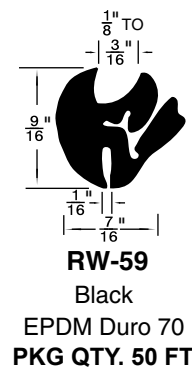
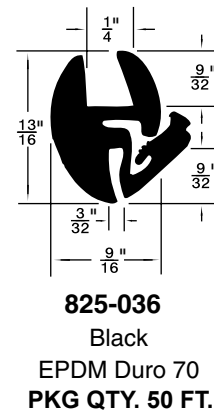
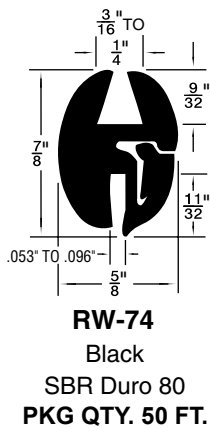
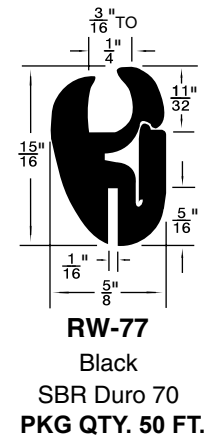
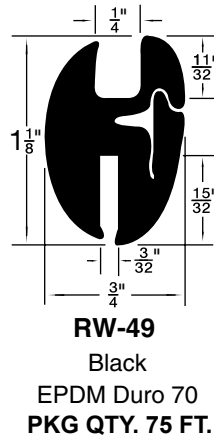
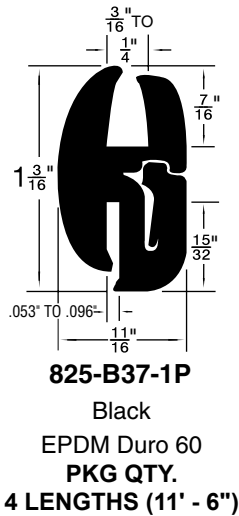

CATALOG 14 SPAENAUR

See section 'R19' for Compound Selection Guide

K