

Tinnerman® Products Table of Contents

Table des matières des produits Tinnerman^{MD}

PRODUCTS / PRODUITS		<i>Page No.</i>
	<p>Engineering Data/Finishes How to Use Section</p> <p>Informations Technique /Traitement de Surface Utilisation de cette Section</p>	C68-C71
	<p>Single Thread Engaging/One-Piece/Self-Retaining (Flat, Round, Anchor, Angle Bracket & W-Type)</p> <p>Écrous Plat/Engagement à un filet (Plat, Rond, Ancre, Angle et Forme -W)</p>	C72-C74
	<p>Single Thread Engaging/One-Piece/Self-Retaining (J-Type, U-Type, Expansion, Specials)</p> <p>Écrous à Pince pour Montage en aveugle (Forme-J, Forme-U, Expansion, Spéciaux)</p>	C75-C83
	<p>Nut & Bolt Retainers (Standard, Self-anchoring & J-Type Nut Retainers)</p> <p>Écrous et Vis en Cage (Regulier, Ancre et Écrous Forme-J)</p>	C84-C87, C100-C101
	<p>Stud Receivers/One-Piece/Self-Locking (Push-On, Grooveless, Ball Stud, Tubular)</p> <p>Écrous Tubulaires (Clip Standard, Attaches de Fermeture Gougons, Tubulaires)</p>	C88-C94, C97
	<p>Tube, Hose & Harness Clamps/Cable, Wire & Tube Clips (Clutch Type and Clips)</p> <p>Attaches pour Cables et Tubes (Collier couvé, et Agrafe)</p>	C95-C96
	<p>Plastics/Standard & Custom Molded (Cap, Expansion, & Dart Type)</p> <p>Pièces Plastiques Standard et Spéciaux (Capuchon, Expansion, Obturateur)</p>	C98-C99
	<p>Flat Type Speed Nut Removal Tool Outil de dépose d'écrou rapide de type plat</p>	C72
	<p>Pushnut Applicator Tools Outils d'installation d'écrous capuchons</p>	C100

CATALOG 14

SPAENAUR

Tinnerman® Engineering Data

Données d'ingénierie Tinnerman^{MD}

Tinnerman® Fastener Engineering Data

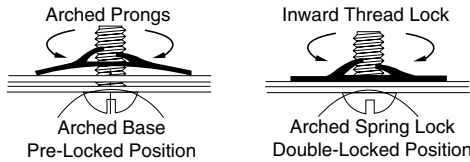

The Tinnerman® Principle of Spring Tension Fastening

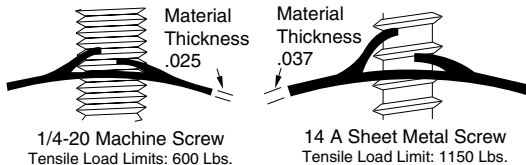

The greater the material thickness, the stronger the Tinnerman® fastener.

Tinnerman® brand fasteners are one-piece and self-locking. They provide an inward thread lock plus an arched spring lock which are energized as the screw tightens. The combined forces of this double locking action resist vibration loosening... and are exclusive with Tinnerman® spring steel fasteners.

While they provide a strong and reliable double-locking action with standard screws, even greater strength can be attained by increasing the material thickness of the fastener and using A or B-type screws. The example illustrated nearly doubles tensile strength with only a 48% increase in material thickness.

Excessive small parts handling can

be drastically reduced through the use of the Tinnerman principle of spring tension fastening. Fully documented case histories prove that assembly savings of 30 to 80% have resulted from the following inherent benefits:

- easier handling, faster application
- elimination of lockwashers, spanner washers, and other loose pieces
- perform multiple functions
- self-retaining, self-locking
- no special tools, skills for equipment required
- will not "freeze" to threads or clog with paint
- ideal for service locations, reused indefinitely
- lock on unthreaded studs
- many types used without screw, stud or mounting hole.

Screw Lengths

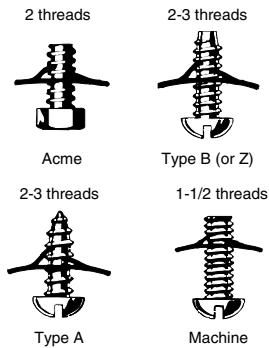

Average Torque And Tensile Values

Tinnerman fasteners are tightened only enough to produce the **inward thread lock** and **arched spring lock** described above. They derive their locking characteristics, holding power and vibration resistance solely from spring tension. Unlike ordinary threaded nuts, they do not have to be tightened with a great amount of torque. In fact, any torque applied beyond the recommended installation torques charted are excessive and could result in loss of spring tension resiliency. The table shows the **average** amount of torque to use in tightening Tinnerman fasteners, plus the **average** tensile load limits. These averages were determined through exhaustive testing. It is recommended that these values be followed. Established as guides for general application. Tests prove that Tinnerman fasteners will withstand greater tensile loads if the screw holes provide **minimum** clearance. These do not apply to self-retaining fasteners, e.g. "U" or "J" types, where part of the fastener engages

All Dimensions in Inches

RECOMMENDED VALUES FOR PEAK FASTENER PERFORMANCE

Screw Size	Threads Per Inch	Max. Dia.	Root Dia.	Standard Max. Thick.	Clearance Hole Dia.	Install. Torque	Tensile Load Limit
2-56	56	.086	.063	.010	.109	*	*
2A	32	.088	.061	.017	.109	*	*
2B	32	.088	.064	.017	.109	*	*
4-36	36	.112	.080	.012	.125	3" lbs.	100 lbs.
4-40	40	.112	.080	.012	.125	3" lbs.	100 lbs.
4A	24	.114	.083	.022	.125	9" lbs.	300 lbs.
4B	24	.114	.086	.022	.125	9" lbs.	300 lbs.
6-32	32	.138	.099	.017	.156	5" lbs.	150 lbs.
6A	18	.141	.102	.025	.156	11" lbs.	400 lbs.
6B	20	.139	.104	.025	.156	11" lbs.	400 lbs.
8-32	32	.164	.125	.017	.187	7" lbs.	250 lbs.
8A	15	.168	.123	.028	.187	17" lbs.	600 lbs.
8B	18	.166	.122	.028	.187	17" lbs.	600 lbs.
10-24	24	.190	.138	.022	.218	12" lbs.	350 lbs.
10A	12	.194	.133	.031	.218	31" lbs	800 lbs.
10B	16	.189	.141	.031	.218	31" lbs.	800 lbs.
12-24	24	.216	.164	.022	.250	12" lbs.	350 lbs.
12A	11	.221	.162	.034	.250	34" lbs.	900 lbs.
1/4-20	20	.250	.188	.025	.281	30" lbs	600 lbs.
14A	10	.254	.185	.037	.281	48" lbs.	1150 lbs.
14B	14	.246	.192	.037	.281	48" lbs.	1150 lbs.
5/16-18	18	.312	.243	.028	.343	30" lbs.	1000 lbs.
5/16B	12	.315	.244	.044	.343	16' lbs.	1200 lbs.
5/16ACME	10	.312	.232	.044	.343	19' lbs.	2200 lbs.
20A	9	.333	.234	.044	.375	*	*
3/8ACME	12	.375	.282	.060	.406	*	*
3/8B	12	.380	.309	.060	.406	19' lbs.	2500 lbs.
24A	9	.390	.291	.060	.421	*	*

the mounting, or clearance hole. The proper lengths of machine screws to use with Tinnerman® fasteners are the same as for general practice, i.e., 1-1/2 thread protrusion beyond the threads (or prongs of the fastener).

Since A- or B-type sheet metal screws taper at the end, longer screws must be used. Sheet metal

*computed on application.

screws **must** protrude 2 to 3 threads beyond the prongs to assure proper grip on the full root diameter of the screw.

Important

All Tinnerman® fasteners shown on these pages are of the Standard-Thread Fit Class unless otherwise specified!

Tinnerman® Standard Finishes

Finitions de série Tinnerman^{MD}

Standard Finishes For Tinnerman® Fasteners.

Listed below are the most commonly used finishes available for protective coating and rust-proofing Tinnerman® Brand Fasteners.

To specify desired finish use corresponding dash number, shown below as **the last dash number**, affixed to the Manufacturer's No.

Examples: C183-012-**27**, C1053-012-**4**, C1158-5610-**1**

FINISH	DESCRIPTION	COLOUR	ADVANTAGES	SALT SPRAY TEST
-27 Soluble Oil Dipped	Ferrous parts (except stainless steel) have a light coating of soluble oil applied. Non-ferrous parts are cleaned where necessary and are left in plain condition.	Natural.	Low-cost finish, recommended on ferrous parts for conditions of relatively little corrosion or for parts that are to receive a finish in the customer's plants.	5% solution at 95° F. Ferrous parts: first rust spots after 1 hour, end point (1/16" dia. rust spots) after 2-1/2 hours. Non-ferrous parts: corrosion will be normal for the plain finish of the material.
-4 Phosphate and Oil	Parts are phosphate coated, then dipped in a special oil and spun dry.	Black.	Moderate corrosion resistance. Neat in appearance — will not wear off in handling.	5% solution at 95° F. First rust spots after 32. hours. End point (1/16" dia. rust spots) after 48 hours.
-1 Phosphate and 2 Coats Olive Drab Paint	Parts are phosphate coated, then two coats of olive drab paint are applied. Each coat is properly baked to obtain maximum protection.	Olive drab.	Good corrosion resistance. Does not cause hydrogen embrittlement common with electroplated high carbon spring steel. Excellent for insulating dissimilar metals against electrolytic action.	5% solution at 95° F. First rust spots after 48 hours. End point (1/16" dia. rust spots) after 96 hours. Being replaced by finishes -255 & -963
-67 Phosphate and 2 Coats Aluminum Paint	Parts are phosphate coated, then two coats of aluminum paint are applied. Each coat is properly baked to insure maximum protection.	Aluminum colour—smooth appearance.	Recommended in place of cadmium plating where appearance and corrosion resistance are requirements. High in abrasion resistance and a non-conductor of electricity.	5% solution at 95° F. rust spots after 48 hours. End point (1/16" dia. rust spots) after 96 hours. Being replaced by finishes -255 & -963
-373 Phosphate, 2 Coats of Paint and Oil	Parts are phosphate coated, then two coats of a bright green paint are applied. Each coat is properly baked. A supplementary coat of a special oil solution is added to insure the maximum corrosion resistance possible.	Bright green.	Exceptional corrosion resistance. Insulates dissimilar metals against electrolytic action. Does not cause hydrogen embrittlement.	5% solution at 95° F. First rust spots after 150 hours. End point (1/16" dia. rust spots) after 250 hours.
-255 & -963 Water based zinc coating Dacromet 320 or equivalent Plus clear sealer.	Parts are coated in a water based zinc coating for maximum protection.	Grey metallic	Exceptional corrosion resistance. Does not cause hydrogen embrittlement.	-255 5% solution at 95° F. End point (1/16" dia. rust spots) after 330 -963 5% solution at 95° F. End point (1/16" dia. rust spots) after 400 hours.
-252 Water based zinc coating plus water base organic black coating	Parts are water based zinc coated with the second coat being an organic finish.	Black	Exceptional corrosion resistance. Does not cause hydrogen embrittlement.	5% solution at 95° F. End point (1/16" dia. rust spots) after 400 hours.
NOTE: The following electroplate finishes are limited to only a few parts, such as Tubular Type Clips and Tube Clamps. Please do not specify these finishes for other types of Tinnerman Fasteners without the approval of our engineering department.				
-600 Zinc Mechanical-plate	Parts are mechanically plated from .00015" to .0003" thick. A clear chromate is applied as a sealer.	Satin Silver Colour	Excellent electrical conductivity and moderate corrosion resistance. No hydrogen embrittlement.	5% solution at 95° F. End point (red rust) after 24 hours.
-3B Zinc Electroplate	Parts are zinc electroplated from .00015" to .0002" thick and baked to reduce hydrogen embrittlement.	Silver colour. Slight discoloration from baking may occur.	Excellent electrical conductivity and moderate corrosion resistance.	5% solution at 95° F. End point (red rust) after 24 hours.

CATALOG 14 SPAENAUR

Tinnerman® - How to Use

Tinnerman^{MD} – mode d'emploi

How To Use the Tinnerman® Section of the SPAENAUR Catalog.

This Tinnerman® Fastener section is designed to help solve your fastening problems quickly and efficiently. The index lists type and product illustrations for easy location and quick reference. Once the category and type of fastener required has been determined, isolating the exact design is a simple matter of deduction. The basic or standard designs are shown in the dimensional drawings on each charted page. Major reference dimensions are shown as variable call-out letters which appear in the column heads of the chart. The charts are organized as follows:

<p>1</p> <p>Column one shows the SPAENAUR No. given to the Tinnerman® part in stock.</p> <p>2</p> <p>Column two is the Manufacturer's No. The dash numbers specify screw size, stud size, material thickness and are critical for proper identification. If a SPAENAUR No. precedes the Manufacturer's part number the last dash number is the finish. When ordering state the preferred finish.</p> <p>3</p> <p>Column three, states the screw size, stud size, tube dia., panel range, etc. found in bold type, which are prime factors for easy selection.</p>	<p>4</p> <p>Design Variations column indicates whether a part is standard (as drawn and specified "Std.") or a modification of standard e. g. A, B, C or ABC in combination. Such variations are identified and illustrated. Parts are available only as specified in the Design Variation column. Further modification requires special tooling and order processing.</p> <p>5...</p> <p>The remaining columns chart the reference dimensions such as length A, width B, edge of panel to mounting hole C, material thickness T. These call-out letters have been standardized to always represent the same dimension (e.g., A is always length). This makes is easier to discuss dimensions without confusion.</p>
--	--

Materials Guide For Plastic Fasteners

Plastic materials for Tinnerman® Fasteners are selected for their most appropriate characteristics, such as temperature factors, flame resistance, impact strength, etc. All fasteners are designed for top quality performance whether for general use or specific application.

Material	Part No. Suffix	Flame Class	Expansion Type	Toggles & Clinch Types	Wall-board Toggle	Cap Nut	Poly-Clamp	Dart Type	Clamps & Ratchet Strap	Adhesive Clamps	Sleeve	Slide Seal	TPI Insert	Screw	Special
ABS	-AE	SB													■
Acetal	-AG	SB						■						■	
Nylon	-AA	SE	■	■			●	●	■		■			●	
Glass-Filled Nylon	-AC	SB													■
Polycarbonate	-AF	SE											■		
Polyethylene	-AB	SB				■	●					■			
Polypropylene	-AD	SB		●	■	●	■	●	■		■				
Rigid PVC	-AR	SE								■					

■ Standard Material ● Optional Material SB = Slow Burning SE = Self-Extinguishing

ABS
A versatile engineering thermo-plastic offering the best balance of properties of common rigid thermoplastic materials — good heat resistance, good impact strength, good low-temperature properties, excellent electrical properties, and fair-to good chemical resistance. Plateable grades available.

ACETAL
An engineering thermoplastic that offers strength, rigidity, and good moisture, heat, and chemical resistance. Excellent abrasion resistance.

NYLON
Most common materials for standard plastic fasteners. Structurally strong, nylon features low coefficient of friction, good insulating properties, resistance to heat (self-extinguishing), shock, vibration, and chemical solvents. Light, elastic; has superior torque strength. Available glass filled or unfilled.
Material has temperature range of -40° to 250°F.

POLYCARBONATE
Most desirable balance of properties of any thermoplastic material available — excellent high and low temperature strength, good heat resistance (up to 250°F under load), high impact strength (in -275 to +250°F range), excellent dimensional stability, nontoxic, self-extinguishing, and excellent electrical insulation.

POLYETHYLENE
Low-cost, medium-strength material. Good insulator and has "rubber-like" characteristics. Can be used for temperature applications up to 190°F.

POLYPROPYLENE
Lightest of thermoplastics. Excellent chemical, heat, and electrical resistance properties. Is original "living" hinge material. Main disadvantage is low-temperature brittleness. Plateable grades available.

RIGID PVC (Polyvinyl Chloride)
Used for many specials fastener applications. Exceptional resistance to acids, alkalis, and alcohols. Excellent in corrosive applications. Self-extinguishing. Will not impart taste or colour to materials handed. Good abrasion resistance.

TYPICAL APPLICATIONS

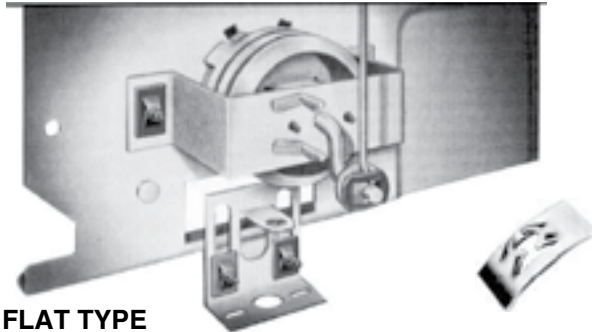

FLAT TYPE

One-piece, self-locking, heat-treated, spring-steel fasteners. Flat type Tinnerman fasteners replace threaded nuts, lock washers and spanner washers. Available in a wide variety of shapes and screw sizes. Also available in round designs with spanner holes for driving. Underside of room air conditioner control panel reveals flat type fasteners in use for reliable vibration-resistant attachments.

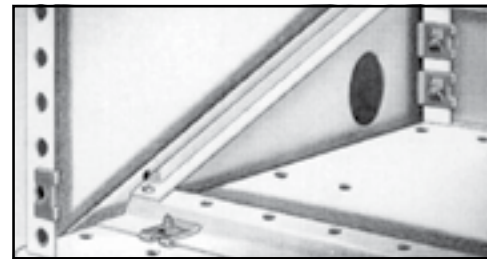

“J” TYPE

Snaps over edge of panels or into centre-hole locations. Holds itself in place for blind assembly. “Floats” freely for easy hole alignment. Electronic console cabinet makes good use of self-retaining “J” types on adjustable shelving installations. Tight tolerances and paint clogging are eliminated and attachments are 3-1/2 times stronger than with former methods.



“U” TYPE

Similar to the “J” type retainer, but has a full lower leg. Ideal for attachments requiring full bearing on lower leg. Extrusion on the lower leg is for instant alignment. Fly-wheel is secured to pump assembly on an automatic transmission unit - application is fast and sure - assembly is dependable and trouble-free.

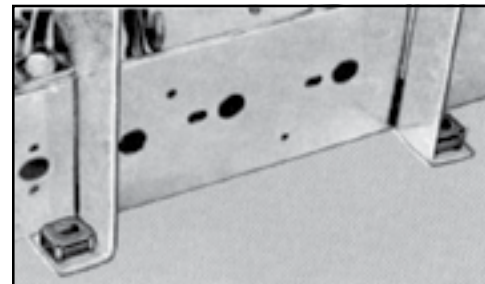

SELF-ANCHORING TYPE

Features a unique locking feature for permanent self-retention. Tinnerman nut retainers are ideal for mounting this television receiver chassis. Sturdy, self-retaining and easily applied, they release special skills and equipment for use in other areas.

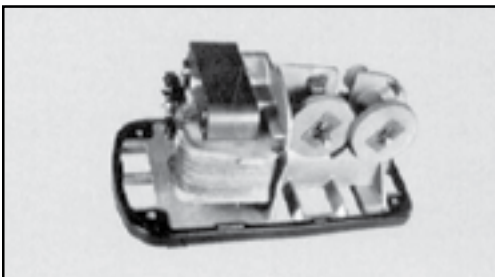

PUSH-ON TYPE

Zips over unthreaded die-cast or plastic studs, rivets, nails, tubing, or wire to lock parts securely. Tinnerman® Standard Push-on type fasteners mount the grinding wheels securely in place on the electric knife sharpener. They bite hard into the shaft for permanent retention.



TUBULAR TYPE

For use with unthreaded studs or rivets, on attachments where there is access to front side only. Permanent lock or removable types. Tubular type Tinnerman fasteners grip mating studs on this removable range top, providing a secure lock, yet allowing the panels to be separated for cleaning and service.

Tinnerman® Flat-Type Panel Clips

Inch

Attaches plates pour panneaux Tinnerman^{MD}

Pouce

FLAT-TYPE Fasteners
(rectangular)

MATERIAL:

All parts are SPRING STEEL, heat treated, unless otherwise specified. The only variations available are those shown with suffix letters in the manufacturer's number:

SS —Stainless Steel BE — Beryllium Copper P — Phosphor Bronze

DESIGN VARIATIONS:

Parts shown as standard or with design variations are available only in that particular design.

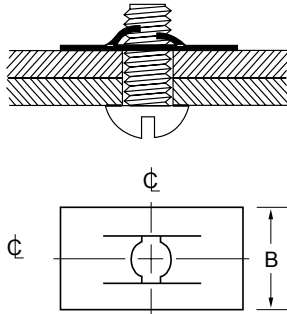

The INCH dimensions of the listed parts are reference dimensions only. For complete design information, please request a blueprint.

DESIGN VARIATIONS

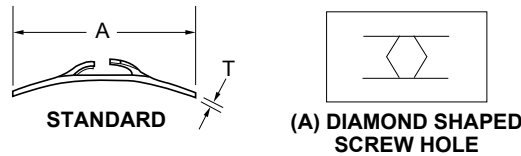

SPAENAUR No.	Tinnerman® Manufacturer's No.	Screw Size	Design Variation	A Length	B Width	T Material Thickness
*1896	C07885-012-27	2-56	Std.	.38	.22	.010
2089	C00410-632-1	6-32	Std.	.51	.31	.017
202-100	C00112-632-4		Std.	.88	.38	.017
TN-145	C08002-8-27	8A or B	Std.	.87	.47	.028
202-029	C07000-1024-4	10-24	Std.	.63	.38	.022
TN-9	D00430-1032-27	10-32	Std.	.75	.44	.017
1900	C07000-10-4	10A or B	Std.	.75	.50	.031
B-1170	D00430-10A-27	10A	Std.	.75	.44	.031
2064	C00917-10A-27		Std.	.88	.38	.031
202-001	C07000-1420-4	1/4-20	Std.	.75	.50	.025

* Limited quantities available.

C68 & C69 **SEE PAGES**

Tinnerman® Fastener Engineering
Data and Standard Finishes

Contact Sales Desk For Package Quantities

TOOL For Removing FLAT TYPE SPEED NUTS

Not Tinnerman® brand

Overall Length 3-3/4"



SPAENAUR No.

T-130

Miniature pry-off bar.
Flips off speed nuts fast!
As a pry-bar, has many uses.

Inch

Tinnerman® Flat-Type Panel Clips

Pouce

Attaches plates pour panneaux Tinnerman^{MD}

FLAT-TYPE Fasteners

(rectangular)

Zip-on Fit

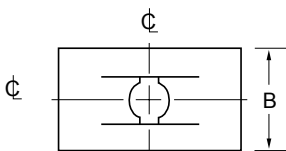
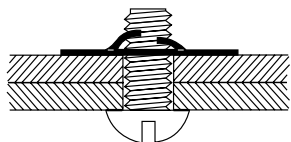

Zip-on fit

Longer, more resilient prongs permit zipping of SPEED NUT over screw threads. Only one or two turns of the screw locks the assembly. Ideal for rapid installation. Not recommended where maximum tensile and torque values are required.

MATERIAL:

All parts are SPRING STEEL, heat treated, unless otherwise specified. The only variations available are those shown with suffix letters in the manufacturer's number:
 SS —Stainless Steel BE — Beryllium Copper P — Phosphor Bronze

DESIGN VARIATIONS:

Parts shown as standard or with design variations are available only in that particular design.

DESIGN VARIATIONS

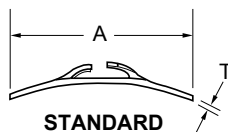

STANDARD

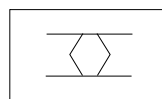

(A) DIAMOND SHAPED SCREW HOLE



(D) ENDS TURNED UP

SPAENAUR No.	Tinnerman® Manufacturer's No.	Screw Size	Design Variation	A Length	B Width	T Material Thickness
TN-132	D07516-017-4	1/2-13	A	1.220	.88	.017
TN-189	C07156-017-1	5/8-11	D	1.450	1.00	.017

The INCH dimensions of the listed parts are reference dimensions only. For complete design information, please request a blueprint.

FLAT-TYPE Fasteners

(round)

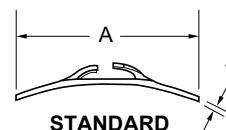
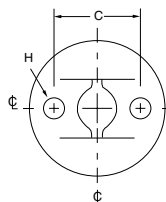
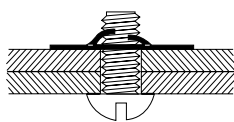

STANDARD

DESIGN VARIATIONS:

Parts shown as standard or with design variations are available only in that particular design.

Dimension in Inches

SPAENAUR No.	Tinnerman® Manufacturer's No.	Screw Size	A Dia.	B* Width	C Centre to Centre	H Hole Dia.	T Mat'l. Thick.
TN-64	C01000-632-27	6-32	.38	.34	—	—	0.17

C68 & C69 SEE PAGES

Tinnerman® Fastener Engineering Data and Standard Finishes

Contact Sales Desk For Package Quantities

CATALOG 14

SPAENAUR

Tinnerman® Flat / W-Type Panel Clips

Inch

Attaches pour panneaux plates / type W Tinnerman^{MD}

Pouce

FLAT-TYPE and Zip-on Fit Fasteners (round)

ZIP-ON FIT: Longer, more resilient prongs permit zipping of SPEED NUT over screw threads. Only one or two turns of the assembly. Ideal for rapid installation. Not recommended where maximum tensile and torque values are required.

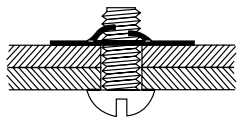

DESIGN VARIATIONS

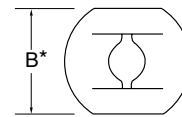
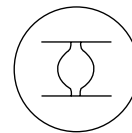
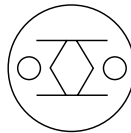
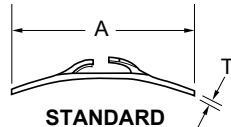
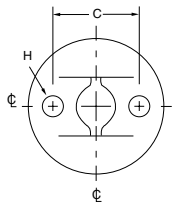

(A) DIAMOND SHAPED SCREW HOLE

(B) NO SPANNER WRENCH HOLES

(C) STRAIGHT SIDES

SPAENAUR No.	Tinnerman® Manufacturer's No.	Screw Size	Design Variation	A Dia.	B* Width	C Centre to Centre	H Hole Dia.	T Mat'rl. Thick.
202-143	C08595-012-4	6-32	BC	.38	.34	—	—	.012
TN-104	C01156-014-4	7/16-20	AC	.91	.69	.694	.101	.014

W-TYPE Fasteners

MATERIAL:

All parts are SPRING STEEL, heat treated, unless otherwise specified. The only variations available are those shown with suffix letters in the manufacturer's number:
SS —Stainless Steel BE — Beryllium Copper P — Phosphor Bronze

DESIGN VARIATIONS:

Parts shown as standard or with design variations are available only in that particular design.

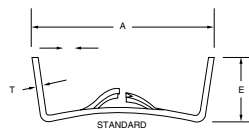
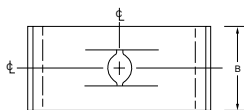
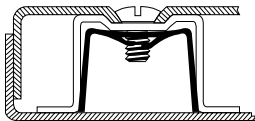

DESIGN VARIATIONS

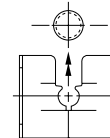

(E) APPLIED FROM SIDE

SPAENAUR No.	Tinnerman® Manufacturer's No.	Screw Size	Design Variation	A Length	B Width	E Height	T Material Thickness
202-055	C06325-1420-1	1/4-20	E	1.01	.88	.24	.025

C68 & C69 **SEE PAGES**

Tinnerman® Fastener Engineering
Data and Standard Finishes

Inch

Tinnerman® J-Type Panel Clips

Pouce

Attaches pour panneaux type J Tinnerman^{MD}

J-TYPE Fasteners

MATERIAL: All parts are SPRING STEEL, heat treated, unless otherwise specified. The only variations available are those shown with suffix letters in the manufacturer's number:

DESIGN VARIATIONS: Parts shown as standard or with design variations are available only in that particular design.

SS - Stainless Steel
P - Phosphor Bronze

BE - Beryllium Copper
S - Low Carbon Steel

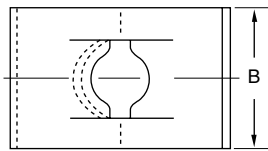
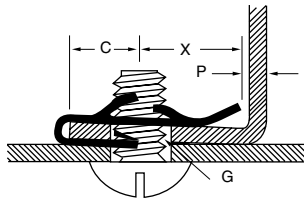

DESIGN VARIATIONS

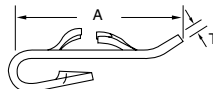

STANDARD

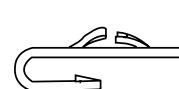

(A) STRAIGHT UPPER LEG

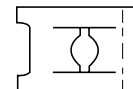

(D) RELIEF NOTCH

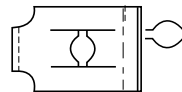

(E) CORNERS CUT OFF

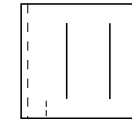

(F) IMPRESSIONS TURNED 90°



(N) KEYHOLE IMPRESSION

The INCH dimensions of the listed parts on this page are reference dimensions only. For complete design information, please request a blueprint.

SPAENAUR No.	Tinnerman® Manufacturer's No.	Screw Size	Design Variation	P Panel Range	A Length	B Width	C Max Centre Hole to Edge	X Centre Imp. to End	G Panel Hole Dia.	T Mat'l. Thick-ness
202-064 TN-238	D08019-632-4	6-32	ADF	.025-.040	.47	.50	.218	.21	.187	.017
	C08022-632-27		AE	.045-.062	.63	.31	.296	.29	.187	.017
TN-168 TN-37 TN-111	C08027-6-27	6A or B	AE	.025-.040	.63	.31	.296	.29	.187	.025
	C08029-6-27		AE	.025-.040	.81	.31	.468	.30	.187	.025
	C08026-6-27		ADF	.045-.062	.47	.50	.218	.20	.187	.025
TN-14 TN-234	C01690-832-27	8-32	AF	.032-.040	.50	.50	.265	.21	.250	.017
	C08034-832-27		AEN	.045-.062	.68	.41	.328	.30	.218	.017
TN-182	C01248-8A-27	8A	E	.115-.128	.63	.44	.250	.30	.218	.025
B-1131	C09125-8-27	8A or B	ADF	.023-.051	.48	.50	.250	.20	.218	.028
202-157	C08043-1024-4	10-24	ADFN	.025-.040	.59	.63	.203	.28	.250	.022
2303 B-1155	C01573-10A-27	10A	ADF	.027-.045	.47	.69	.203	.24	.265	.031
	C00834-10A-1		DF	.040-.050	.64	.63	.343	.27	.281	.031
TN-38	C08052-10-27	10A or B	AE	.045-.062	.78	.50	.359	.36	.250	.031
B-1173	C00702-1420-27	1/4-20	D	.040-.051	.78	.50	.312	.40	.343	.025
202-P31-1M	C01246-14-27		AE	.093-.105	.87	.56	.468	.36	.343	.034

(Special J-Type Fasteners on following page.)

CATALOG 14 SPAENAUR

Contact Sales Desk For Package Quantities

Tinnerman® U-Type Panel Clips

Inch

Attaches pour panneaux type U Tinnerman^{MD}

Pouce

U-TYPE Fasteners

MATERIAL: All parts are SPRING STEEL, heat treated, unless otherwise specified. The only variations available are those shown with suffix letters in the manufacturer's number:

DESIGN VARIATIONS: Parts shown as standard or with design variations are available only in that particular design.

SS - Stainless Steel
P - Phosphor Bronze

BE - Beryllium Copper
S - Low Carbon Steel

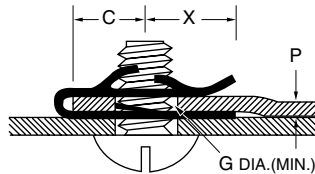

DESIGN VARIATIONS

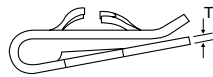

STANDARD

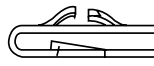

(A) STRAIGHT UPPER LEG



(B) CORNER TURNED UP



(C) NO EXTRUSION ON LOWER LEG

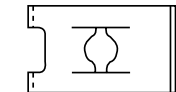
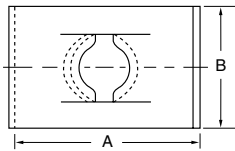

(D) RELIEF NOTCH

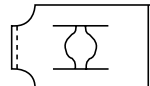

(E) CORNERS CUT OFF

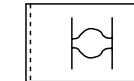

(F) IMPRESSION TURNED 90°



(N) KEYHOLE IMPRESSION

The INCH dimensions of the listed parts on this page are reference dimensions only. For complete design information, please request a blueprint.

SPAENAUR No.	Tinnerman® Manufacturer's No.	Screw Size	Design Variation	P Panel Range	A Length	B Width	C Max Centre Hole to Edge	X Centre Imp to End	G Panel Hole Dia.	T Mat'rl. Thick-ness
202-151	C09815-632-1	6-32	ABC	.012-.031	.38	.31	.187	.19	.187	.017
202-065	C08093-632-4		E	.045-.062	.65	.31	.296	.30	.187	.017
TN-225	C15471-632-27		EN	.135-.150	.51	.31	.265	.23	.187	.017
202-091	C08104-832-1	8-32	E	.025-.040	.69	.41	.328	.31	.218	.017
202-P10-1P	C08106-832-4		E	.025-.040	.86	.41	.515	.31	.218	.017
202-068	C09807-832-4		CN	.031-.051	.52	.44	.250	.22	.218	.017

Continues on Next Page

C68 & C69 SEE PAGES

Tinnerman® Fastener Engineering Data and Standard Finishes

Contact Sales Desk For Package Quantities

Inch

Tinnerman® U-Type Panel Clips

Pouce

Attaches pour panneaux type U Tinnerman^{MD}

U-TYPE Fasteners

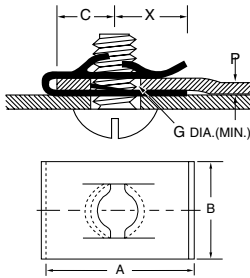

MATERIAL: All parts are SPRING STEEL, heat treated, unless otherwise specified. The only variations available are those shown with suffix letters in the manufacturer's number:

- SS - Stainless Steel
- BE - Beryllium Copper
- P - Phosphor Bronze
- S - Low Carbon Steel

DESIGN VARIATIONS:

Parts shown as standard or with design variations are available only in that particular design.

DESIGN VARIATIONS

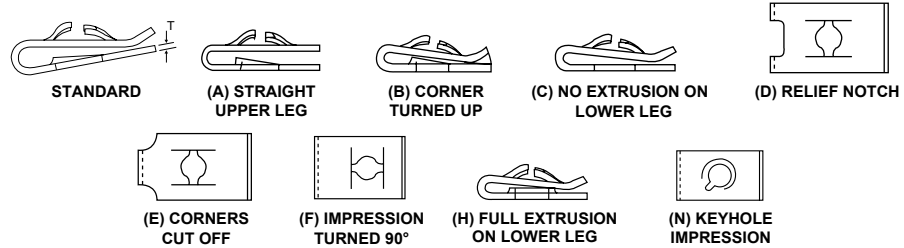

The INCH dimensions of the listed parts on this page are reference dimensions only. For complete design information, please request a blueprint.

SPAENAUR No.	Tinnerman® Manufacturer's No.	Screw Size	Design Variation	P Panel Range	A Length	B Width	C Max Centre Hole to Edge	X Centre Imp to End	G Panel Hole Dia.	T Mat'l. Thickness
TN-232	C01022-8A-27	8A	C	.025-.064	.83	.44	.500	.31	.187	.028
202-142	C01022-8A-255		C	.025-.064	.83	.44	.500	.31	.187	.028
B-993	C00636-8A-27		ADF	.040-.051	.53	.50	.218	.26	.250	.028
202-114	C11137-8A-255	8A or B	AC	.187-.218	.59	.44	.250	.24	.187	.028
202-041	C08109-8-3B		DF	.045-.062	.52	.50	.234	.26	.218	.028
TN-53	C08111-8-27		E	.045-.062	.67	.41	.328	.32	.218	.028
TN-101	D07159-8-27		D	.055-.080	.71	.44	.281	.31	.281	.028
202-092	D11539-8-1	8B	CD	.081-.094	.61	.44	.281	.30	.281	.028
202-261	D09031-8-4		DF	.102-.125	.70	.63	.406	.25	.281	.028
202-090	C01787SS-8Z-27	8B	D	.025-.064	.84	.44	.500	.32	.281	.028
202-189	C09223-8Z-27		ABD	.120-.140	.90	.63	.531	.32	.265	.028
202-088	D98214-8Z-4		Std.	.156-.187	1.16	.54	.750	.32	.281	.028
202-164	D01155-1024-27	10-24	CD	.025-.064	.64	.44	.312	.31	.218	.020
TN-188	C01379-1024-27		ND	.025-.064	.84	.44	.500	.32	.281	.020
TN-257	C00550-1024-27		H	.025-.081	.63	.44	.312	.30	.312	.020
202-109	D01152-1024-4		CD	.025-.093	.63	.44	.312	.31	.250	.020
202-063	C07674-1024-4	DF	.036-.050	.46	.50	.250	.18	.281	.020	
TN-34	C8115-1024-27	10-24	DF	.045-.062	.56	.63	.250	.25	.250	.022
TN-118	C09040-1024-27		N	.100-.120	.62	.44	.265	.30	.281	.020

Continued...

C68 & C69 **SEE PAGES**

Tinnerman® Fastener Engineering Data and Standard Finishes

SPAENAUR No.	Tinnerman® Manufacturer's No.	Stud Size
TN-54	C22228-031-27	.090

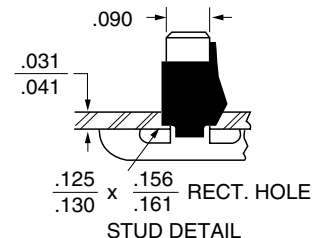
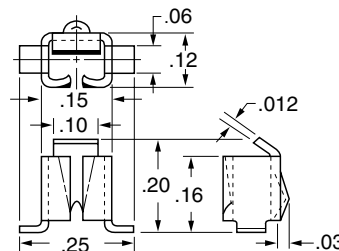

Contact Sales Desk For Package Quantities

Tinnerman® U-Type Panel Clips

Inch

Attaches pour panneaux type U Tinnerman^{MD}

Pouce

U-TYPE Fasteners

MATERIAL: All parts are SPRING STEEL, heat treated, unless otherwise specified. The only variations available are those shown with suffix letters in the manufacturer's number:

SS - Stainless Steel
P - Phosphor Bronze

BE - Beryllium Copper
S - Low Carbon Steel

DESIGN VARIATIONS:

Parts shown as standard or with design variations are available only in that particular design.

DESIGN VARIATIONS

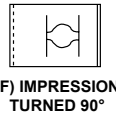
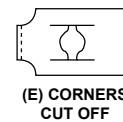
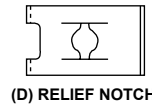
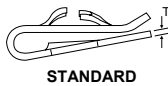
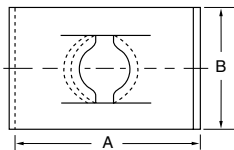
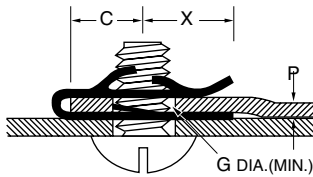

The INCH dimensions of the listed parts on this page are reference dimensions only. For complete design information, please request a blueprint.

SPAENAUR No.	Tinnerman® Manufacturer's No.	Screw Size	Design Variation	P Panel Range	A Length	B Width	C Max Centre Hole to Edge	X Centre Imp to End	G Panel Hole Dia.	T Mat'l. Thick-ness
202-061	C00575-1024-4	10-24	C	.115-.130	.63	.44	.250	.32	.218	.020
TN-193	C01880-1024-27		Std.	.156-.187	1.14	.44	.750	.31	.281	.020
202-062	D00907-10-27	10A	AEFHM	.030-.043	.50	.53	.250	.25	.265	.031
202-087	D09223-10A-255		ABD	.120-.140	.90	.63	.531	.32	.265	.031
202-P21-1A	D08834-10-27	10A or B	DF	.023-.050	.47	.50	.250	.22	.281	.031
TN-149	D00636-10-27		ADF	.040-.051	.53	.50	.218	.26	.250	.031
TN-131	D11621-10-4		CDF	.051-.064	.46	.50	.250	.21	.281	.031
202-005	C01793-10-27		DF	.064-.093	.70	.63	.437	.24	.281	.031
202-119	D07343-1420-4	1/4-20	C	.062-.125	.96	.50	.500	.41	.281	.025
B-1154	C06520-1420-27		Std.	.093-.125	.89	.50	.437	.43	.375	.025
TN-112	C08126-14A-27	14A	E	.028-.056	.93	.56	.421	.43	.312	.037
TN-133	C10392-14Z-27	14B	Std.	.105-.120	.98	.50	.500	.45	.343	.040
TN-186	D07511-5618-27	5/16-18	A	.112-.140	1.04	.63	.562	.40	.375	.028

C68 & C69 **SEE PAGES**

Tinnerman® Fastener Engineering Data and Standard Finishes

CATALOG 14

SPAENAUR

Inch and Metric

Pouce et Métrique

Tinnerman® U-Type Panel Clips

Attaches pour panneaux type U Tinnerman^{MD}

U-TYPE Fasteners

(Standard)

MATERIAL: All parts are SPRING STEEL, heat treated, unless otherwise specified. The only variations available are those shown with suffix letters in the manufacturer's number:

SS - Stainless Steel
P - Phosphor Bronze

BE - Beryllium Copper
S - Low Carbon Steel

DESIGN VARIATIONS:

Parts shown as standard or with design variations are available only in that particular design.

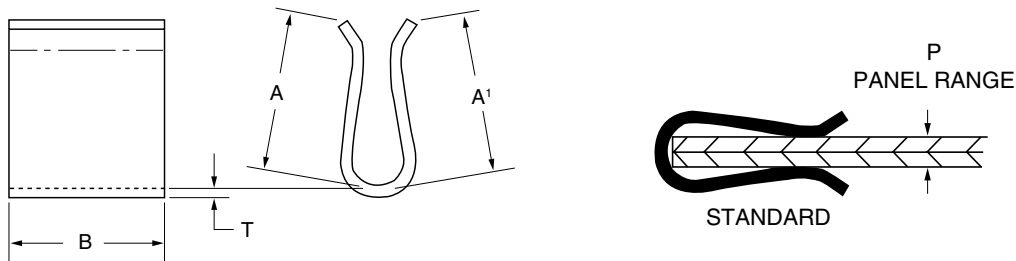

DESIGN VARIATIONS

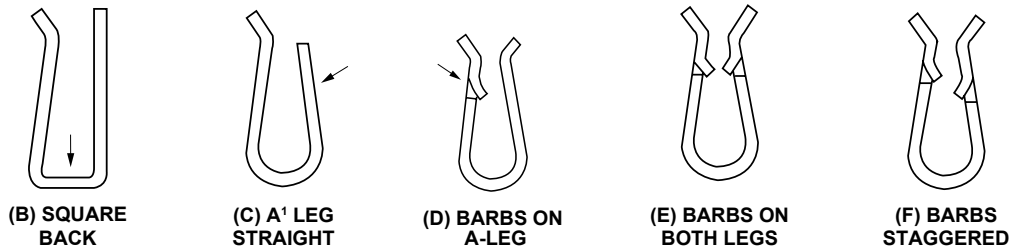

The INCH dimensions of the listed parts are reference dimensions only. For complete design information, please request a blueprint.

SPAENAUR No.	Tinnerman® Manufacturer's No.	P Panel Range	Design Variation	A	A1	B Width	T Matr'l. Thick.
202-146	D27091-014-27	.115-.185	E	.42	.42	.50	.014
202-112	D20285-014-4	.050-.100	CE	.34	.35	.50	.014
88786	D98284-014-27	.080-.140	D	.36	.29	.38	.014
086-F46-1X	C29495-025-4	.140-.200	D	.74	.67	.63	.025
202-154	D56491-036M-373	3.81-4.31	E	10.29-11.05	10.29-11.05	12.45-12.95	.36
202-072	C45931-014-4	.245-.255	BE	.36	.36	.50	.014

C68 & C69 **SEE PAGES**

Tinnerman® Fastener Engineering
Data and Standard Finishes

Tinnerman® U-Type Panel Clips

Inch

Attaches pour panneaux type U Tinnerman^{MD}

Pouce

U-TYPE Fasteners (Special)

MATERIAL: All parts are SPRING STEEL, heat treated, unless otherwise specified. The only variations available are those shown with suffix letters in the manufacturer's number:

SS - Stainless Steel
P - Phosphor Bronze

BE - Beryllium Copper
S - Low Carbon Steel

DESIGN VARIATIONS: Parts shown as standard or with design variations are available only in that particular design.

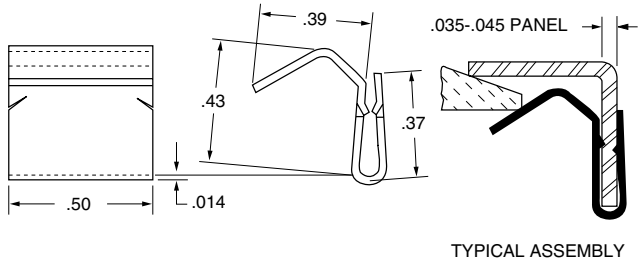

SPAENAUR No.	Tinnerman® Manufacturer's No.	Panel Range
202-080	C44320-014-1	.035-.045

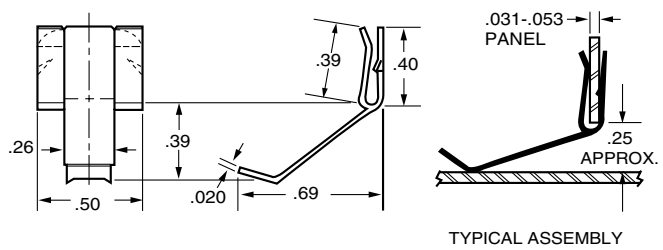

SPAENAUR No.	Tinnerman® Manufacturer's No.	Panel Range
202-167	C28464-020-4	.031-.053

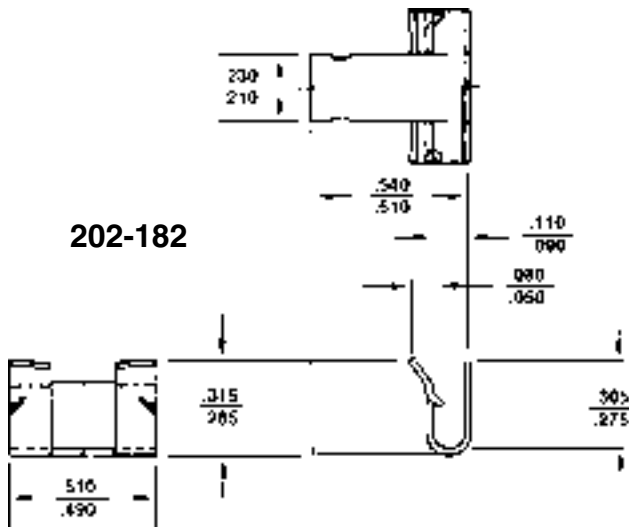

202-182

The INCH dimensions of the listed parts are reference dimensions only. For complete design information, please request a blueprint.

SPAENAUR No.	Tinnerman® Manufacturer's No.	P Panel Range	T Matr'l. Thick.
202-182	C41412-017-4	.070-.090	.017

SPECIAL PURPOSE Fasteners

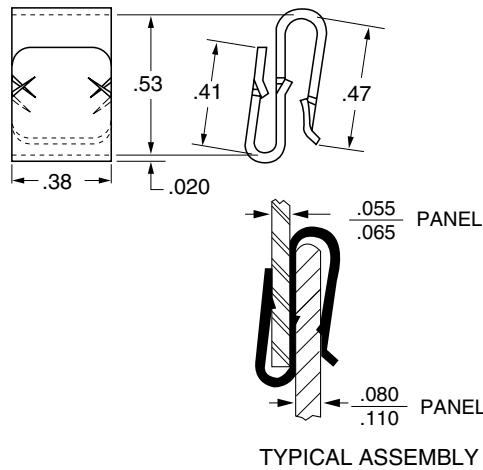

SPAENAUR No.	Tinnerman® Manufacturer's No.	Panel Ranges
086-350	D40991-020-4	.055-.065 .080-.110

C68 & C69 **SEE PAGES**

Tinnerman® Fastener Engineering Data and Standard Finishes

Contact Sales Desk For Package Quantities

Inch

Tinnerman® U-Type Panel Clips

Pouce

Attaches pour panneaux type U Tinnerman^{MD}

U-TYPE Fasteners (Special)

**WIDE PANEL RANGE U-NUTS
NO CENTRE BACK LEG.**

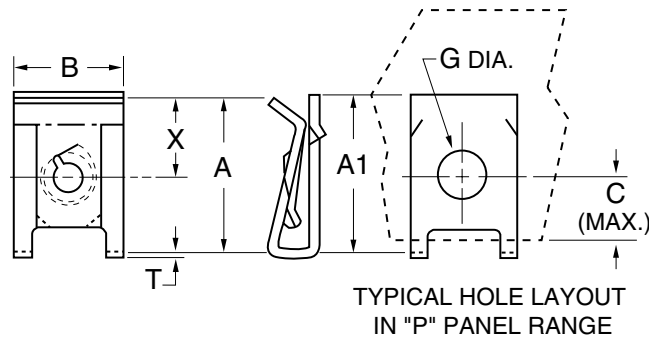

The INCH dimensions of the listed parts on this page are reference dimensions only. For complete design information, please request a blueprint.

SPAENAUR No.	Tinnerman® Manufacturer's No.	Screw Size	P Panel Range	A	A1	B	C	X Centre to Edge	G Panel Hole	T Mat'rl. Thick.
202-047	D06377-8AB-4	8AB	.070-.150	.67	.75	.53	.312	.380	.328	.028

U-TYPE Fasteners (Special)

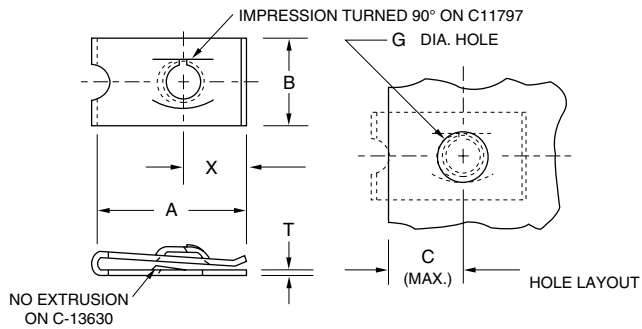

The INCH dimensions of the listed parts on this page are reference dimensions only. For complete design information, please request a blueprint.

SPAENAUR No.	Tinnerman® Manufacturer's No.	Screw Size	Panel Range	Installation Torque	A	B	C	G	X	T
TN-129	C11797-020-27	10A	.060-.080	21 in lbs.	.75	.63	.400	.281	.30	.020

CATALOG 14

SPAENAUR

C68 & C69 **SEE PAGES**

Tinnerman® Fastener Engineering
Data and Standard Finishes

Contact Sales Desk For Package Quantities

Tinnerman® U-Type Panel Clips

Inch

Attaches pour panneaux type U Tinnerman^{MD}

Pouce

U-TYPE Fasteners (Special)

MATERIAL: All parts are SPRING STEEL, heat treated, unless otherwise specified. The only variations available are those shown with suffix letters in the manufacturer's number:

SS - Stainless Steel
P - Phosphor Bronze

BE - Beryllium Copper
S - Low Carbon Steel

DESIGN VARIATIONS: Parts shown as standard or with design variations are available only in that particular design.

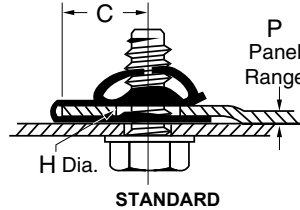
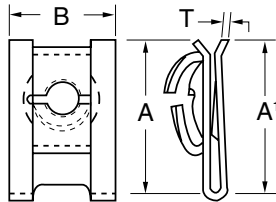

STANDARD

SPAENAUR No.	Tinnerman® Manufacturer's No.	Screw Size	Design Variation	P Panel Range	A Length	A' Length	B Width	C Max Hole to Edge	H Min. Dia.	T Mat'rl. Thick.
202-051	D98320-071M-1	8AB	Std.	.035-.045	.634	.720	.540	.320	.320	.028

U-TYPE Fasteners (Special)

MATERIAL: All parts are SPRING STEEL, heat treated, unless otherwise specified. The only variations available are those shown with suffix letters in the manufacturer's number:

SS - Stainless Steel
P - Phosphor Bronze

BE - Beryllium Copper
S - Low Carbon Steel

DESIGN VARIATIONS: Parts shown as standard or with design variations are available only in that particular design.

WIDE PANEL RANGE U-TYPE FASTENERS

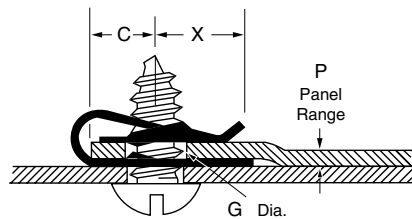
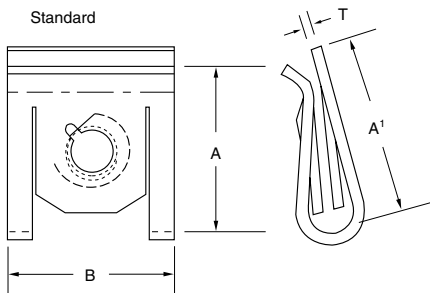

DESIGN VARIATIONS



SPAENAUR No.	Tinnerman® Manufacturer's No.	Screw Size	Design Variation	Panel Range	A	A'	B	C	X	G	T
202-035	D19640-8AB-4	8B or AB	AC	.025-.150	.770	.770	.53	.250	.420	.280	.028
202-046	D19641-8AB		AC	.025-.150	.970	1.000	.53	.470	.385	.280	.028

SEE PAGES **C68 & C69**

Tinnerman® Fastener Engineering Data and Standard Finishes

Contact Sales Desk For Package Quantities

Inch

Tinnerman® U-Type Panel Clips

Pouce

Attaches pour panneaux type U Tinnerman^{MD}

U-TYPE Fasteners (Special)

MATERIAL THICKNESS .011

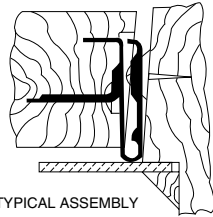

MATERIAL: All parts are SPRING STEEL, heat treated, unless otherwise specified. The only variations available are those shown with suffix letters in the manufacturer's number:

- SS - Stainless Steel
- P - Phosphor Bronze
- BE - Beryllium Copper
- S - Low Carbon Steel

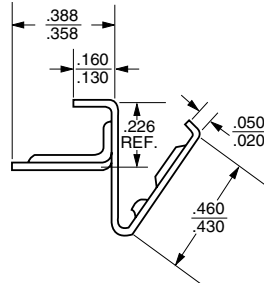

Special Shape Speed Clip

SPAENAUR No.	Tinnerman® Manufacturer's No.
202-110	D44215-011-4

The INCH dimensions of the listed parts on this page are reference dimensions only. For complete design information, please request a blueprint.

U-TYPE Fasteners (Special)

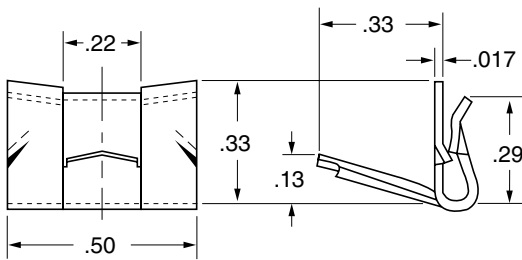

.031-.041 PANEL

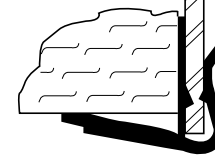

SPAENAUR No.	Tinnerman® Manufacturer's No.	Panel Range
202-070	C22960-017-255	.031-.041

SPAENAUR No. 202-183

Mfr. No. C21116-020-4

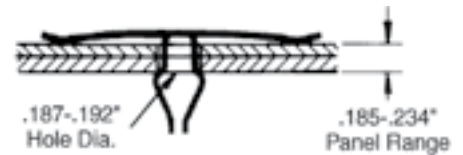
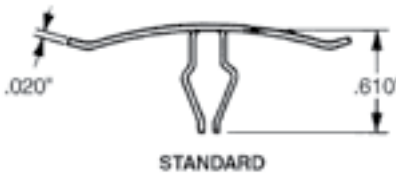
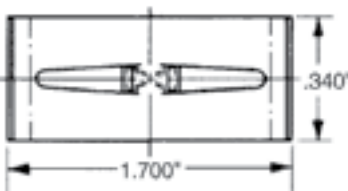

PANEL CLIPS

SPAENAUR No. C-1072

Mfr. No. D03568-022-27

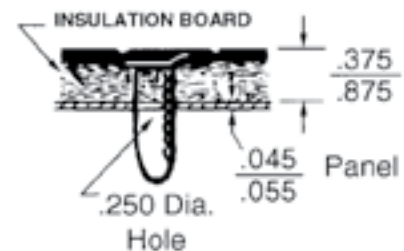
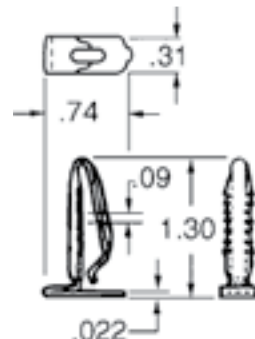

The INCH dimensions of the listed parts are reference dimensions only. For complete design information, please request a blueprint.

Contact Sales Desk For Package Quantities

Tinnerman® Nut Retainers

Inch

Retenues d'écrous Tinnerman^{MD}

Pouce

STANDARD NUT RETAINERS

MATERIAL: All retainers are SPRING STEEL, heat treated unless otherwise specified.
Square Nuts — Low Carbon Steel

FINISH: Available in -4, -27, -24, -3B only.

Metric — all standard nut retainers can be made available in equivalent metric thread sizes.

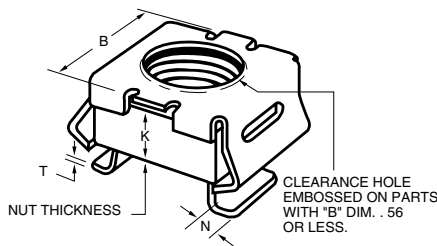
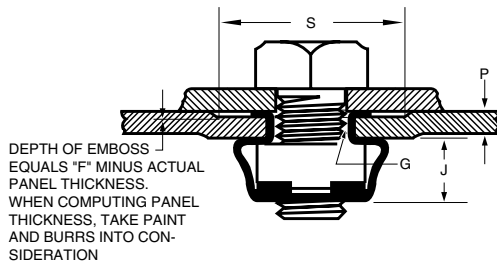

G Mounting hole layout variations:

Where more than one hole layout is assigned to a part, the smaller is recommended when the panel is subjected to extraordinarily rough handling previous to the insertion of the screw.

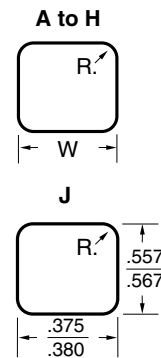

Style	R.	W
A	.03	.375-.380
B	.03	.343-.348

The INCH dimensions of the listed parts are reference dimensions only.
For complete design information, please request a blueprint.

SPAENAUR No.	Tinnerman® Manufacturer's No.	Screw Size	P Panel Range	F	S Emboss Square (min.)	G Mounting Hole	B	J	N	K	T Mat'rl. Thickness
2501	D07931-1032-27	10-32	.025-.063	.100	.531	A or B	.52	.25	.06	.156	.020
202-136	D07931-1032-3B		.025-.063	.100	.531	A or B	.52	.25	.06	.156	.020
202-P05-1M	D07941-1032-3B		.064-.105	.140	.531	A or B	.52	.25	.06	.156	.020
◆202-169	D98579-1032-81		.064-.105	.140	.531	A or B	.52	.25	.06	.156	.020

◆Stainless Steel, waxed finish

Continues on Next Page

SEE PAGES **C68 & C69**

Tinnerman® Fastener Engineering
Data and Standard Finishes

Contact Sales Desk For Package Quantities

Inch

Tinnerman® Nut Retainers

Pouce

Retenues d'écrous Tinnerman^{MD}

STANDARD NUT RETAINERS

MATERIAL: All retainers are SPRING STEEL, heat treated unless otherwise specified.

Square Nuts — Low Carbon Steel

FINISH: Available in -4, -27, -24, -3B only.

Metric — all standard nut retainers can be made available in equivalent metric thread sizes.

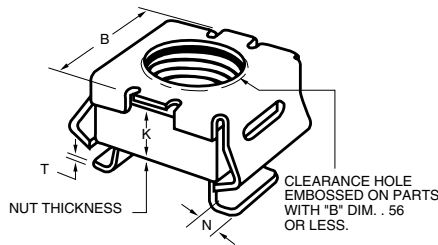
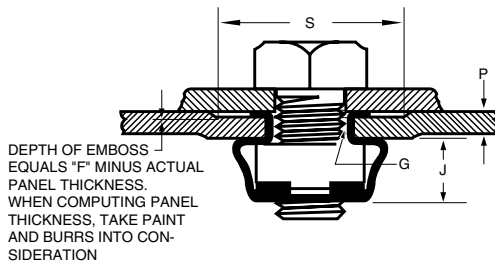

G Mounting hole layout variations:

Where more than one hole layout is assigned to a part, the smaller is recommended when the panel is subjected to extraordinarily rough handling previous to the insertion of the screw.

Style	R.	W
A	.03	.375-.380
B	.03	.343-.348
C	.13	.503-.508
D	.031	.460-.465

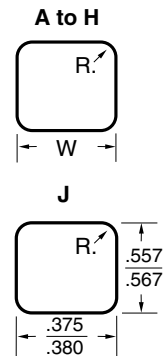

The INCH dimensions of the listed parts are reference dimensions only. For complete design information, please request a blueprint.

SPAENAUR No.	Tinnerman® Manufacturer's No.	Screw Size	P Panel Range	F	S Emboss Square (min.)	G Mounting Hole	B	J	N	K	T Mat'rl. Thickness
TN-6R	D07988-1420-27	1/4-20	.025-.063	.100	.531	A or B	.52	.25	.06	.187	.020
202-128	D07988-1420-4		.025-.063	.100	.531	A or B	.52	.25	.06	.187	.020
202-129	D07988-1420-3B		.025-.063	.100	.531	A or B	.52	.25	.06	.187	.020
202-130	D07998-1420-3B		.064-.105	.140	.531	A or B	.52	.25	.06	.187	.020
202-124	D07956-1420-3B		.093-.126	.160	.531	A or B	.52	.25	.06	.187	.020
202-125	D07956-1420-3F	.093-.126	.160	.531	A or B	.52	.25	.06	.187	.020	
202-122	D07953-5618-3B	5/16-18	.057-.092	.135	.734	C or D	.66	.30	.10	.218	.025
202-127	D07957-5618-3B		.093-.126	.175	.734	C or D	.66	.30	.10	.218	.025

Continues on Next Page

C68 & C69 SEE PAGES

Tinnerman® Fastener Engineering Data and Standard Finishes

Contact Sales Desk For Package Quantities

Tinnerman® Nut Retainers

Inch

Retenues d'écrous Tinnerman^{MD}

Pouce

STANDARD NUT RETAINERS

MATERIAL: All retainers are SPRING STEEL, heat treated unless otherwise specified.

Square Nuts — Low Carbon Steel

FINISH: Available in -4, -27, -24, -3B only.

Metric — all standard nut retainers can be made available in equivalent metric thread sizes.

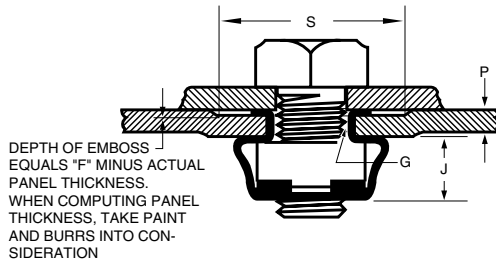

G Mounting hole layout variations:

Where more than one hole layout is assigned to a part, the smaller is recommended when the panel is subjected to extraordinarily rough handling previous to the insertion of the screw.

A to H

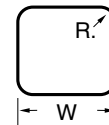

K

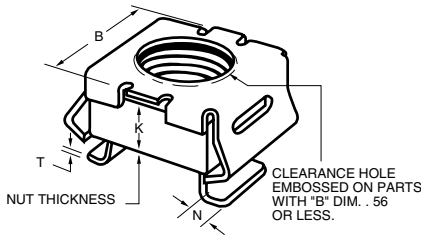
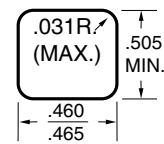

Style	R.	W
C	.13	.503-.508
D	.031	.460-.465
E	.06	.588-.593
F	.031	.573-.578
G	.12	.590-.610
H	.06	.559-.564

The INCH dimensions of the listed parts are reference dimensions only. For complete design information, please request a blueprint.

SPAENAUR No.	Tinnerman® Manufacturer's No.	Screw Size	P Panel Range	F	S Emboss Square (min.)	G Mounting Hole	B	J	N	K	T Mat'rl. Thickness
202-166	D07935-5618-3B	5/16-18	.127-.162	.205	.734	C or D	.66	.30	.10	.218	.025
202-081	D31910-5618-4		.177-.197	.245	.734	C or D	.66	.30	.10	.218	.025
TN-59R	D07953-3816-4	3/8-16	.057-.092	.135	.734	C or D	.66	.30	.10	.218	.025
202-126	D07957-3816-3B		.093-.126	.175	.734	C or D	.66	.30	.10	.218	.025
202-131	D30683-3816-4		.162-.210	.245	.828	G or F	.87	.41	.10	.304	.025

SEE PAGES **C68 & C69**

Tinnerman® Fastener Engineering Data and Standard Finishes

Contact Sales Desk For Package Quantities

Inch

Tinnerman® Nut Retainer Assortment

Pouce

Assortiment de retenues d'écrous Tinnerman^{MD}

ASSORTMENT 805-640G



Tinnerman® Spring Nuts and Tubular Stud Retainers

SPRING STEEL - HEAT TREATED

An excellent kit for general industrial maintenance, electronics, repair shops, etc. as well as for automotive general use. Inside label shows illustrations and size data.

Separate refill items available in "Unit Packages"

65 Varieties 875 Pieces

Contains a full range of all most popular sizes, in **Flat, U and J Type Spring Nuts, and Tubular Stud Retainers.**

Furnished in Large Size grey enamel drawer with scooped bins for easy access. Drawers will fit into Slide Racks shown on page A3

Shipping Weight: **4.31 kg** (9.5 lbs.)



Name	Spaenaur No.	Thread Size	Nut Thickness	Qty.	Page	
Flat Type Fastener Rectangular	1896	#2-56	0.010"	25	C72	
	1898	#6-32	0.017"			
	TN-7	#8-32	0.033"			
	202-203	#8B	0.033"	15	C72	
	202-029	#10-24	0.022"			
	1901	#10-32	0.017"	25	C72	
	TN-9					
	1900	#10A	0.031"	15		
	B-1170					
	2064			10		
	202-001	1/4"-20	0.025"	15		
	202-401					
	J Type Fasteners	202-064	#6-32	0.017"	10	C75
B-1131		#8	0.028"	8		
2303		#10	0.031"	10		
202-P23-1Y						
B-1155						
2055						
TN-38		#14	0.034"	12		
B-1186						
2059						
B-1166		1/4"-20	0.025"	8		
B-1173						
202-044						
Flat Type Fasteners Round Zip-On Fit	202-139	#8-32	0.012"	25	C74	
Name	Spaenaur No.	Compatible Stud ø	Speed Nut Shape	Qty.	Page	
Push-On Type Fasteners Round Studs	B-1167	0.062"	Rectangular	10	C88	
	TN-13	0.093"		15		
	1909	0.100"		40		
	1906			25		
	1914	0.125"		10	C88	
	1897	0.153" - 0.157"		Round	15	C89
	202-159	0.156"	Rectangular	12	C90	
	TN-99	0.187"		20		
	1905	0.187"		25		
	2102			10		
	202-071	0.250"		Round		15
	TN-171	0.250"		Rectangular		10
	2104	0.250"	Round	12		
	202-057	0.357"	Rectangular	15		
	B-1182	0.500"		22		
	2106	0.625"		10		
	TN-146	0.625"		10		
	202-P02-1T	0.625"	10			
	TN-184	0.625"	10			
Name	Spaenaur No.	Compatible Stud ø	Compatible Panel Thickness	Qty.	Page	
Tubular Type Fasteners	TN-125	0.062"	0.025" - 0.125"	10	C95	
	TN-95	0.088"	0.032" - 0.040"			
	TN-54	0.090"	0.031" - 0.041"	12	C77	
	TN-254	0.093" - 0.105"	0.031" - 0.042"			
	TN-5	1/8"	0.038" - 0.044"	15	C94	
	B-1190		0.050" - 0.060"			
	B-1380	0.180"	0.020" - 0.032"	10	C104	
	TN-229	0.184" - 0.190"	0.036" - 0.042"			
	2066	3/16"	0.038" - 0.044"	12		
	TN-66	1/4"	0.034" - 0.040"	10	C77	
Name	Spaenaur No.	Compatible Stud ø	Nut Thickness	Qty.	Page	
Push-On Type Rectangular Studs Special	2060	0.250"	0.017"	10		
Name	Spaenaur No.	Compatible Screw Size	Compatible Panel Thickness	Qty.	Page	
U Type Fasteners	202-193	#8A or B	0.025" - 0.040"	8	C78	
	B-993	#8A	0.040" - 0.051"	10		
	2062	#10A	0.030" - 0.043"	8		
	TN-149	#10A or B	0.040" - 0.051"	10		
	TN-131		0.051" - 0.064"			
	202-202		0.102" - 0.125"			
	2293	1/4"-20	0.064" - 0.125"	12	C79 H34	

Tinnerman® Push-On Type Fasteners

Inch

Fixations de type à pression Tinnerman^{MD}

Pouce

PUSH-ON TYPE Fasteners

(round studs)

MATERIAL: All parts are SPRING STEEL, heat treated, unless otherwise specified. The only variations available are those shown with suffix letters in the manufacturer's number:

SS - Stainless Steel
P - Phosphor Bronze

BE - Beryllium Copper
S - Low Carbon Steel

DESIGN VARIATIONS:

Parts shown as standard or with design variations are available only in that particular design.

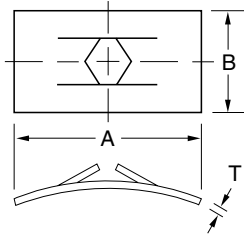

STANDARD RECTANGULAR

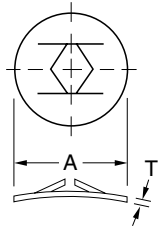

STANDARD ROUND

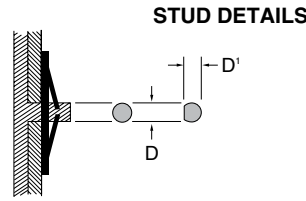

IMPRESSION "A" IS REMOVABLE WHEN USED WITH A D-SHAPED STUD

DESIGN VARIATIONS

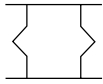

(A) FOR ROUND STUDS AND STUDS WITH D' WIDTH

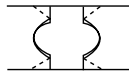

(B) FOR HARDENED STUDS



(D) 4 PRONG-SHEARED



(L) SIDES CUT OFF



(P) TURNED UP ENDS



(R) NO ARCH IN BASE

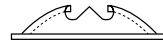

(T) SPHERICAL DOME

The INCH dimensions of the listed parts are reference dimensions only. For complete design information, please request a blueprint.

SPAENAUR No.	Tinnerman® Manufacturer's No.	Stud Size		Type	Design Variation	A Length or Dia.	B Width	T Mat'l. Thick.
		D Dia.	D' Width					
B-1167	C01619-014-27	.062	—	Rect.	Std.	.88	.31	.014
202-390	C15164-012-27	.078	—	Round	AL	.38	.34	.012
TN-13	C08148-017-27	.093	—	Rect.	B	.45	.23	.017
1914	C0711-017-27	.125	—	Rect.	Std.	.50	.31	.017
TN-35	C01128-012-27	.120-.125	—	Rect.	P	.80	.31	.012
TN-167ZP	C12042-017-3B	.124-.126	—	Round	L	.38	.34	.017
1897	C00109-012-27	.125	.085	Rect.	A	.58	.31	.012
202-171	D12003-014-4		.100	Rect.	A	.58	.31	.014
202-159	C12003-017-4		.100	Rect.	A	.58	.31	.017
TN-87	C08153-012-27	.125	.100	Rect.	A	.90	.50	.012
202-137	C14100-014SS-27		—	Round	DR	.38	—	.014
TN-121	C11943-017-27		—	Round	A	1.38	—	.017
TN-99	C12043-012-4	.153-.157	—	Round	L	.38	.34	.012

Continues on Next Page

SEE PAGES **C68 & C69**

Tinnerman® Fastener Engineering
Data and Standard Finishes

Contact Sales Desk For Package Quantities

Inch

Tinnerman® Push-On Type Fasteners

Pouce

Fixations de type à pression Tinnerman^{MD}

PUSH-ON TYPE Fasteners

(round studs)

MATERIAL: All parts are SPRING STEEL, heat treated, unless otherwise specified. The only variations available are those shown with suffix letters in the manufacturer's number:

SS - Stainless Steel
P - Phosphor Bronze

BE - Beryllium Copper
S - Low Carbon Steel

DESIGN VARIATIONS: Parts shown as standard or with design variations are available only in that particular design.

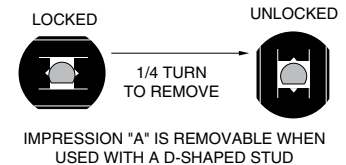
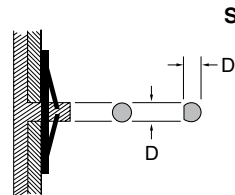
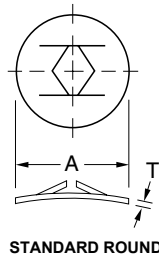
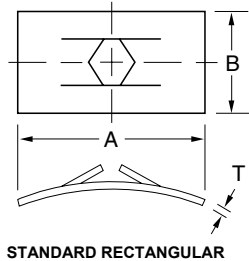

DESIGN VARIATIONS

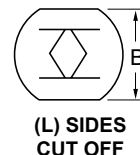
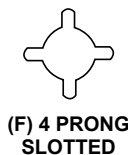
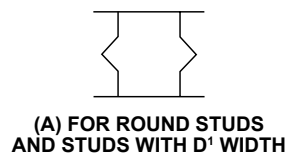

The INCH dimensions of the listed parts are reference dimensions only. For complete design information, please request a blueprint.

SPAENAUR No.	Tinnerman® Manufacturer's No.	Stud Size		Type	Design Variation	A Length or Dia.	B Width	T Mat'rl. Thick.
		D Dia.	D' Width					
202-156	D00433-012-27	.156	—	Rect.	Std.	.75	.44	.012
202-060	C17324-014-4	.170	—	Round	L	.50	.38	.014
202-071	C12005-017-4	.187	.150	Rect.	A	.63	.38	.017
202-102	C12045-012-4	.218	—	Round	L	.50	.38	.012
202-057 B-1182 2106	C12007-017-4	.250	.200	Rect.	A	.63	.44	.017
	C01540-017-1		—	Rect.	Std.	.95	.63	.017
	C00183-012-27		—	Round	Std.	.56	—	.012
202-150	C13113-014-4	.265	—	Round	Std.	.56	—	.014
202-004	C00185-014-4	.300	—	Rect.	Std.	.62	.50	.014
202-085	C13329-014-4	.310-.315	—	Round	FR	.64	—	.014

Continues on Next Page

C68 & C69 **SEE PAGES**

Tinnerman® Fastener Engineering
Data and Standard Finishes

Contact Sales Desk For Package Quantities

Tinnerman® Push-On Type Fasteners

Inch

Fixations de type à pression Tinnerman^{MD}

Pouce

PUSH-ON TYPE Fasteners

(round studs)

MATERIAL: All parts are SPRING STEEL, heat treated, unless otherwise specified. The only variations available are those shown with suffix letters in the manufacturer's number:

SS - Stainless Steel
P - Phosphor Bronze

BE - Beryllium Copper
S - Low Carbon Steel

DESIGN VARIATIONS:

Parts shown as standard or with design variations are available only in that particular design.

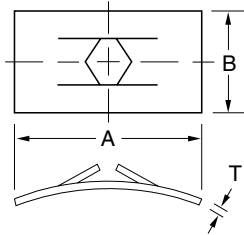

STANDARD RECTANGULAR

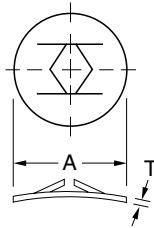

STANDARD ROUND

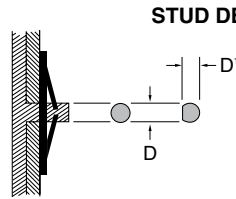

IMPRESSION "A" IS REMOVABLE WHEN USED WITH A D-SHAPED STUD

DESIGN VARIATIONS

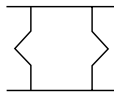

(A) FOR ROUND STUDS AND STUDS WITH D' WIDTH



(P) TURNED UP ENDS

The INCH dimensions of the listed parts are reference dimensions only. For complete design information, please request a blueprint.

SPAENAUR No.	Tinnerman® Manufacturer's No.	Stud Size		Type	Design Variation	A Length or Dia.	B Width	T Mat'rl. Thick.
		D Dia.	D' Width					
202-082	C11653-017-27	.312	—	Round	Std.	1.380	—	.017
202-172	C12009-020-4	.375	.300	Rect.	A	.75	.56	.020
TN-146	C12010-017-4		—	Rect.	P	1.00	.69	.017
202-P02-1T	C00867-017-27	.500	—	Rect.	P	.92	.75	.017
TN-184	C00507-017-27	.625	—	Rect.	P	1.49	1.00	.017

SEE PAGES

C68 & C69

Tinnerman® Fastener Engineering Data and Standard Finishes

Contact Sales Desk For Package Quantities

Inch

Tinnerman® Push-On Type Fasteners

Pouce

Fixations de type à pression Tinnerman^{MD}

PUSH-ON TYPE Fasteners

MATERIAL: All parts are SPRING STEEL, heat treated, unless otherwise specified. The only variations available are those shown with suffix letters in the manufacturer's number:

DESIGN VARIATIONS: Parts shown as standard or with design variations are available only in that particular design.

SS - Stainless Steel
P - Phosphor Bronze

BE - Beryllium Copper
S - Low Carbon Steel

(round stud specials)

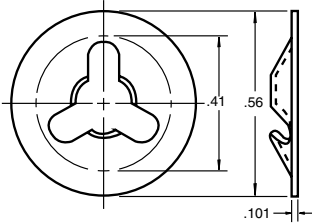

SPAENAUR No.	Manufacturer's No.	Stud Dia.
TN-45	C14562-010-4	.186-.192

(odd shaped stud special)

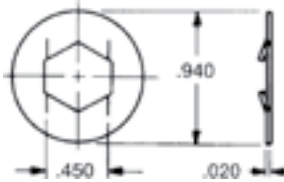

For 7/16" Hex Rod.

SPAENAUR No.	Manufacturer's No.	Stud Dia.
202-177	D05282-020-4	.437 Hex

PUSH-ON TYPE Fasteners

MATERIAL: All parts are SPRING STEEL, heat treated, unless otherwise specified. The only variations available are those shown with suffix letters in the manufacturer's number:

DESIGN VARIATIONS: Parts shown as standard or with design variations are available only in that particular design.

SS - Stainless Steel
P - Phosphor Bronze

BE - Beryllium Copper
S - Low Carbon Steel

(rectangular stud)

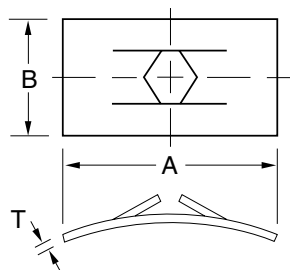

STANDARD RECTANGULAR

STUD DETAIL
(Studs Engage As Shown)

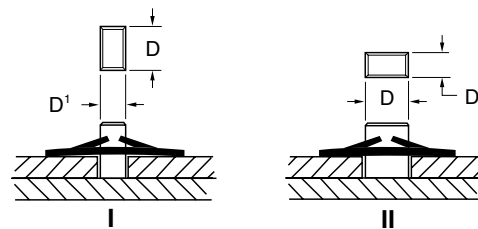

SPAENAUR No.	Manufacturer's No.	Stud Size		Type	Stud Detail	A Length or Dia.	B Width	T Mat'rl. Thick.
		D Length	D1 Width					
TN-241	C09451-010-4	.181-.190	.181-.190	Rect.	I or II	.63	.38	.010

SEE PAGE **C57**

SEE PAGES **C68 & C69**

for more Push-on Fasteners Tinnerman® Fastener Engineering Data and Standard Finishes

Contact Sales Desk For Package Quantities

CATALOG 14

SPAENAUR

Tinnerman® Friction Catches & Studs

Inch

Fermeirs et goujons à friction Tinnerman^{MD}

Pouce

BALL-STUD Fasteners

MATERIAL: All parts are SPRING STEEL, heat treated, unless otherwise specified. The only variations available are those shown with suffix letters in the manufacturer's number:

SS - Stainless Steel

Studs— low carbon steel unless otherwise specified.

DESIGN VARIATIONS:

Parts shown as standard or with design variations are available only in that particular design.

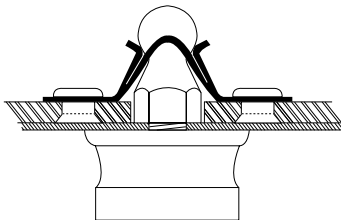
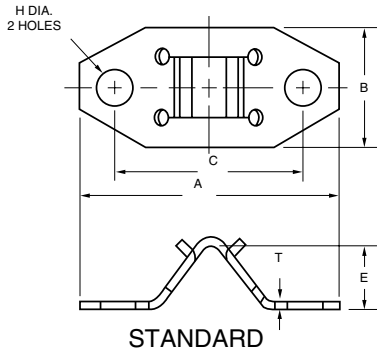

C68 & C69 **SEE PAGES**

Tinnerman® Fastener Engineering Data and Standard Finishes

SPAENAUR No.	Tinnerman® Manufacturer's No.	H Hole Dia.	Design Variation	Pull-Out Tension Stud Type		A Length	B Width	C Ctr. to Ctr.	E Height	T Matr'l. Thick.
				Ball	Serrated					
086-647	C01663-012-3B	.135	Std.	3.5 lbs.	5 lbs.	.97	.44	.685	.22	.012
086-692	C01663-017-3B		Std.	8 lbs.	9 lbs.	.97	.44	.685	.22	.017
086-690	C01663-031-4		Std.	30 lbs.	30 lbs.	.97	.44	.685	.22	.031
◆086-F88-1C	C01663-022-4		Std.	12 lbs.	13 lbs.	.97	.44	.685	.22	.022
086-694	C04883-031-4	.145	Std.	30 lbs.	30 lbs.	.97	.44	.685	.22	.031

◆ Not necessarily Tinnerman® brand

Internally Threaded Studs

SPAENAUR No. C-968

DP-101-525-495
Not Tinnerman® brand
Internal Thread
6-32 NC2

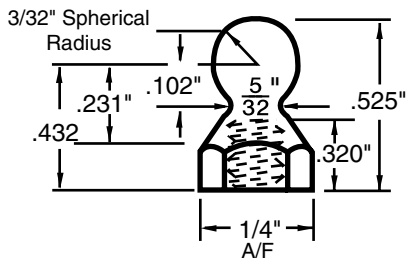

Externally Threaded Studs

SPAENAUR No. 086-689

Mfgr. No. P116
Not Tinnerman® brand
External Thread
M4 x 6 mm long

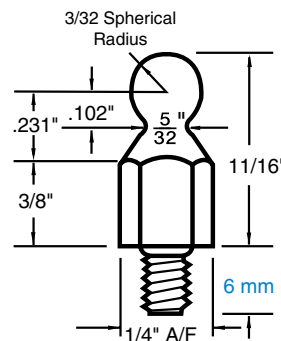

The INCH dimensions of the listed parts are reference dimensions only. For complete design information, please request a blueprint.

Contact Sales Desk For Package Quantities

Inch

Tinnerman® Retaining Rings / Applicator Tools

Pouce

Bagues de retenue / Outils d'installation Tinnerman^{MD}

APPLICATIONS



Grooveless Retainer Rings

(G-R-R's)

The Thin-Wall Stud Receivers

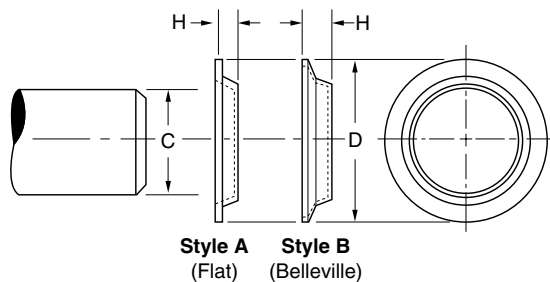

HAND TOOLS

of Tough DELRIN

Black Colour

PKG QTY. 1

Select hand tool listed in the extreme right column, opposite retaining ring numbers.

Retainer Ring SPAENAUR No.	Manufacturer's No.	C Stud Size	Metric Equiv. (mm)	D O.D.	H Height	Mat'l. Thick.	Style	HAND TOOL SPAENAUR No.
260-300	T99220SS-60-576	.093	2.36	.218	.030	.008	A	—
260-302	T99220SS-83-576	.117	2.97	.245	.030	.010	A	—
260-304	T99220SS-58-576	.125	3.17	.245	.025	.006	A	—
260-305	T99220SS-74-576	—	—	.325	.025	.006	A	—
260-306	T99220SS-77-576	.130	3.30	.245	.025	.006	A	—
—	T99220SS-66-576	.156	3.96	.260	.025	.008	A	876-339
—	T99220SS-73-576	.175	4.44	.312	.025	.008	A	876-340
260-314	T99220SS-64-576	.312	7.92	.437	.030	.010	A	—



Superior Stainless Steel Fasteners provide 360° of bearing surface for maximum holding power without a groove!

Tinnerman Grooveless Retainer Rings press over studs, shafts, or any round shape from .046" to .625" diameter. G-R-R's become an integral part of the axial application, replacing snap or bearing rings, cotter pins, staking, swaging, spinning, heat forming, ultrasonics, coining, cementing, or upsetting...eliminating high-cost operations.

Designed without slots, or shears, G-R-R's will not "walk-off" or spring free. Low profile flat designs require a minimum of space. Wall dimensions as thin as .024" make them ideal for limited access locations. They need as little as .032" of shaft or stud extension for full anchor.

Quality stainless steel assures long life, corrosion resistance, minimal distortion, dry finish, eliminates heat treat, finish and handling operations..and the extra costs they entail. A full range of sizes has been developed on modular tooling. Virtually any unlisted size can be made that falls within the limits of the tools, for a one-time set up charge. Sizes beyond this range can be made but require special tooling. Application tools are available for all sizes.

Contact Sales Desk For Package Quantities

Tinnerman® Tubular Panel Clips

Inch

Attaches tubulaires pour panneaux Tinnerman^{MD}

Pouce

TUBULAR TYPE Fasteners

MATERIAL: All parts are SPRING STEEL, heat treated, unless otherwise specified. The only variations available are those shown with suffix letters in the manufacturer's number:

SS - Stainless Steel
P - Phosphor Bronze

BE - Beryllium Copper
B - Brass

DESIGN VARIATIONS: Parts shown as standard or with design variations are available only in that particular design.

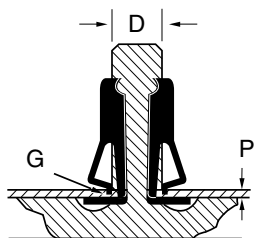
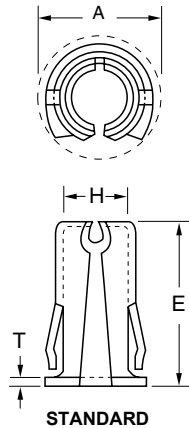

DESIGN VARIATIONS

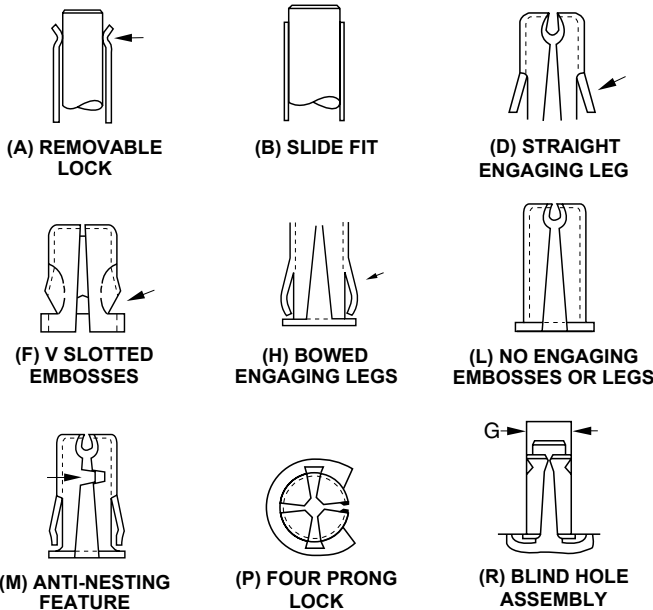

The INCH dimensions of the listed parts are reference dimensions only. For complete design information, please request a blueprint.

SPAENAU No.	Tinnerman® Manufacturer's No.	D Stud Dia.	P Panel Range	Design Variation	A	E Height	H Opening At End	G Panel Hole Dia.	T Matr'l. Thick.
TN-5	C02204-040-4	.125	.038-.044	Std.	.21	.26	.104	.161	.012
TN-73	C02733-040-27		.038-.044	A	.23	.26	.107	.161	.012
202-106	C02252-051-4		.049-.055	B	.23	.26	.121	.161	.012
202-144	D40231-075-4	.184-.190	.075-.085	DP	.34	.31	.125	.250	.017
TN-229	D40231-036-27	.186-.190	.036-.046	DP	.34	.29	.125	.250	.017
2066	C02198-040-27	.187	.038-.044	Std.	.32	.46	.163	.228	.012
B-1380	C02297-020-27	.188	.020-.032	FM	.25	.28	.168	.218	.012
TN-66	C03598-036-252	.250	.034-.040	Std.	.43	.47	.210	.281-.284	.012

C68 & C69 **SEE PAGES**

Tinnerman® Fastener Engineering
Data and Standard Finishes

Contact Sales Desk For Package Quantities

CATALOG 14

SPAENAU

Inch

Tinnerman® Tubular Clips / Wire & Cable Clips

Pouce

Attaches tubulaires / Pincettes pour fils et câbles Tinnerman^{MD}

SPECIAL PURPOSE Fasteners

SPAENAUR No.	Tinnerman® Manufacturer's No.	Stud Size
202-059	C15941-020-4	.186

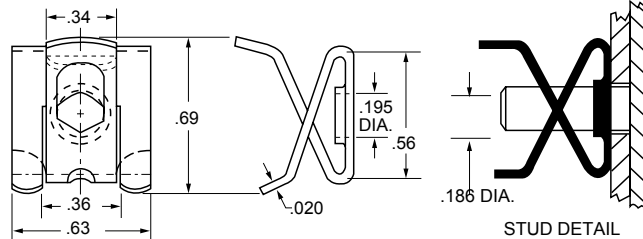

CABLE, WIRE, ROD & TUBE CLIPS

The INCH dimensions of the listed parts are reference dimensions only. For complete design information, please request a blueprint.

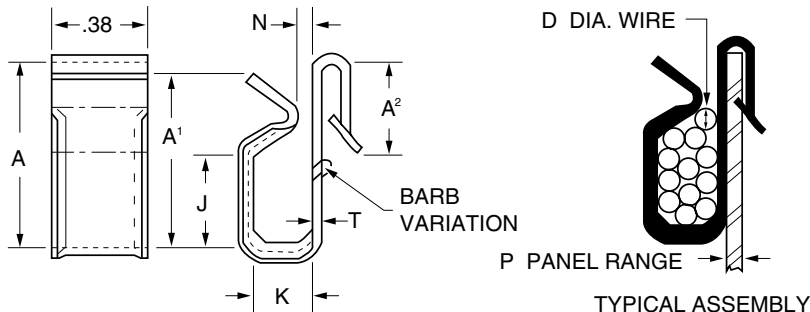

SPAENAUR No.	Tinnerman® Manufacturer's No.	D	P	A	A¹	A²	J	K	N	T
C-439	C26410-017-1	.343 (one)	.083-.093	.81	.81	.40	.41	.28	.14	.017

CABLE, WIRE, ROD & TUBE CLIPS

MATERIAL: All parts are SPRING STEEL, heat treated, unless otherwise specified. The only variations available are those shown with suffix letters in the manufacturer's number:

SS - Stainless Steel
P - Phosphor Bronze

BE - Beryllium Copper
S - Low Carbon Steel

DESIGN VARIATIONS:

Parts shown as standard or with design variations are available only in that particular design.

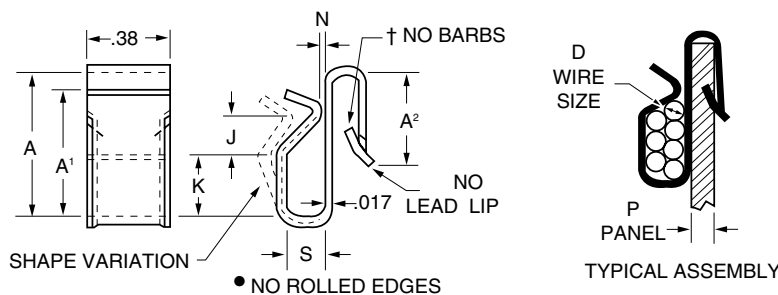

C68 & C69 **SEE PAGES**
Tinnerman® Fastener Engineering
Data and Standard Finishes

SPAENAUR No.	Manufacturer's No.	D	P	A	A¹	A²	J	K	N	S
C-988	C42686-017-4	.090 dia. (seven)	.030-.050	.68	.64	.44	.22	.30	.03	.19
086-019	C28572-017-1	.125 dia. (three)	.135-.165	.60	.62	.43	.18	.29	.03	.19

Contact Sales Desk For Package Quantities

Tinnerman® Tube Clips

Inch

Pinces pour tubes Tinnerman^{MD}

Pouce

TUBE CLIPS

MATERIAL: All parts are SPRING STEEL, heat treated, unless otherwise specified. The only variations available are those shown with suffix letters in the manufacturer's number:

SS - Stainless Steel
P - Phosphor Bronze

BE - Beryllium Copper
S - Low Carbon Steel

DESIGN VARIATIONS:
Parts shown as standard or with design variations are available only in that particular design.

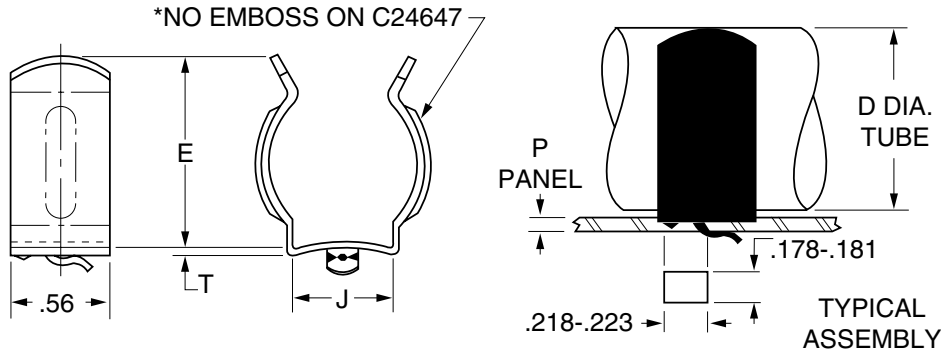

SPAENAUR No.	Tinnerman® Manufacturer's No.	D Tube Dia.	P Panel Range	J Base Width	E Height	T Mat'rl. Thick.
086-033	C24937-11-047-4	1.375 - 1.50	.035/.060	.68	1.40	.020
086-035	D54764-020-255	1.468 - 1.531	.025/.033	—	1.85	—

The INCH dimensions of the listed parts are reference dimensions only. For complete design information, please request a blueprint.

TUBE CLIPS

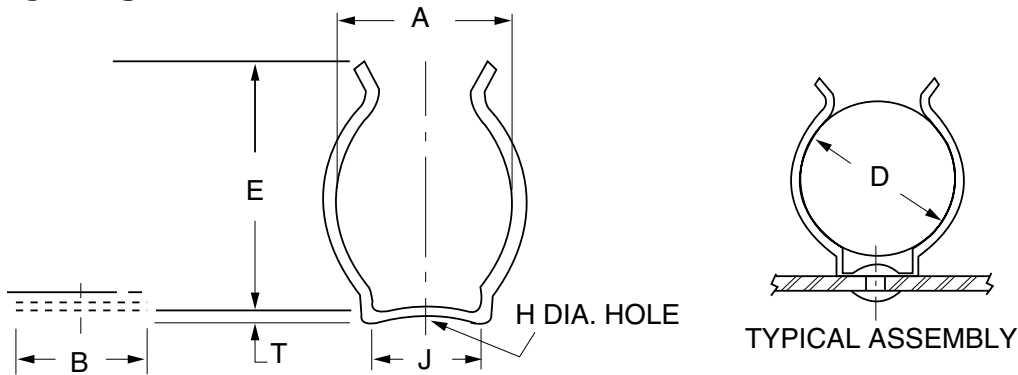

SPAENAUR No.	Tinnerman® Manufacturer's No.	D	A	B	E	H	J	T
086-034	C22275-020-4	1.062-1.312	1.05	.50	1.19	.149	.56	.020

The INCH dimensions of the listed parts are reference dimensions only. For complete design information, please request a blueprint.

Inch

Tinnerman® Push-On Stud Caps

Pouce

Capuchons pour goujons à pression Tinnerman^{MD}

**CAP TYPE PUSH-ON
Plastic Fasteners**

MATERIALS: High density linear polyethylene plastic cap SPRING STEEL, heat treated inserts.

FINISH: Plastic cap — Smooth gloss in choice of colours.

DESIGN VARIATIONS: Parts shown as standard or with design variations are available only in that particular design.

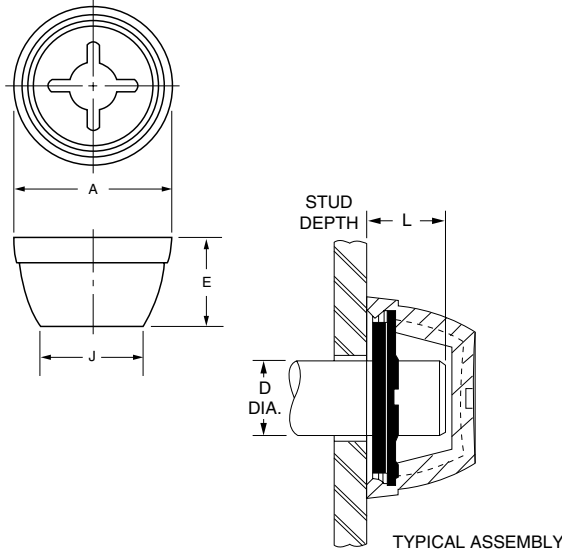

DESIGN VARIATIONS - AT MANUFACTURER'S OPTION.

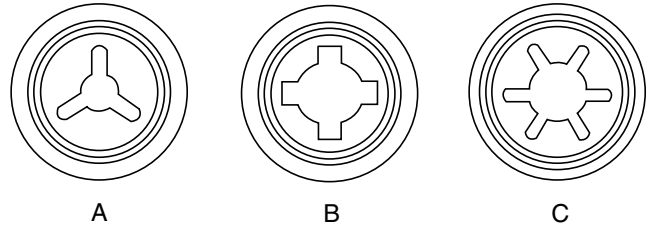

*The INCH dimensions of the listed parts are reference dimensions only.
For complete design information, please request a blueprint.*

SPAENAUR No.	Tinnerman® Manufacturer's No.	D Stud Diameter	Colour	A Dia.	E Height	J Dia.	L
076-022	C60002-125-805	.125	Black	.650	.35	.37	.125-.250
076-012	C60002-187-802	.187	White	.650	.35	.37	.125-.235
076-023	C60002-187-805		Black	.650	.35	.37	.125-.235
076-028	C60002-218-805	.218	Black	.650	.35	.37	.125-.170
076-024	C60012-250-805	.250	Black	.650	.35	.37	.125-.150
076-029	C60008-312-805	.312	Black	.835	.46	.55	.200-.343
076-026	C60008-375-805	.375	Black	.835	.46	.55	.200-.343

Available Colours:

Plastic Cap fasteners are available in eight standard colours; Minimum quantities may apply:

- Natural (-801)
- Red (-803)
- Black (-805)
- Yellow (-807)
- White (-802)
- Blue (-804)
- Silver (-806)
- Green (-808)

When ordering, add the dash number shown next to colour selected, to the Manufacturer's No.
Example: C60002-125-805 (black)

C68 & C69 SEE PAGES

Tinnerman® Fastener Engineering
Data and Standard Finishes

Contact Sales Desk For Package Quantities

Tinnerman® Clinch Type / Tinnerman® Plastic Inserts

Inch

Écrous autobloquants Tinnerman^{MD} / Douilles en plastique Tinnerman^{MD}

Pouce

CLINCH TYPE Plastic Fasteners

MATERIAL: Nylon (AA).
FINISH: Natural or black.

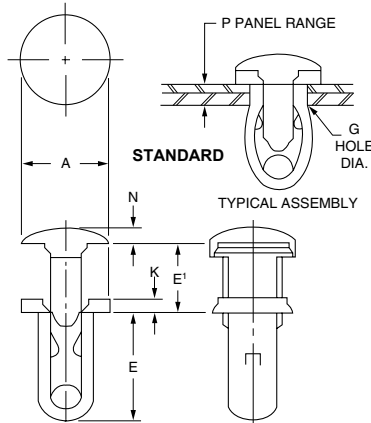

DESIGN VARIATIONS:
Parts shown as standard or with design variations are available only in that particular design.

The INCH dimensions of the listed parts are reference dimensions only. For complete design information, please request a blueprint.

SPAENAUR No.	Tinnerman® Manufacturer's No.	G Hole Dia.	P Panel Range	Design Variation	A	E	E'	K	N
086-211	C60203AA-020-801	.125	.020-.174	Std.	.25	.39	.235	.04	.04

Tinnerman® Plastic Inserts

MATERIAL: Polycarbonate Resin.
FINISH: Natural.

DESIGN VARIATIONS:
Parts shown as standard or with design variations are available only in that particular design.



Tinnerman® Plastic Inserts... may be easily rapped into wood or plastic as an insert, or wrenched on studs like a nut. Either way, TPI's provide solid, secure fastening at minimum cost.

Two types of TPI nuts are available: **Pretapped**, used with machine screws for greater ease of assembly and **Plain** for use with tapping or machine screws where prevailing torque is a requisite. The screw forms its own thread as driven. Listed are sizes for No. 10 through 5/16" screws showing torque and tensile values.

When seated as an insert, the 8-point splined body prevents rotation as the screws driven or removed. Used as a nut, the splines fit a standard 8-point socket wrench. TPI's are molded of polycarbonate resin which has many inherent advantages. It is non-toxic, has a very low absorption rate and can be painted. Mechanical properties approach those of metals. It is also corrosion proof, has excellent dielectric properties and will withstand temperatures ranging from -50 to 250 degrees Fahrenheit.

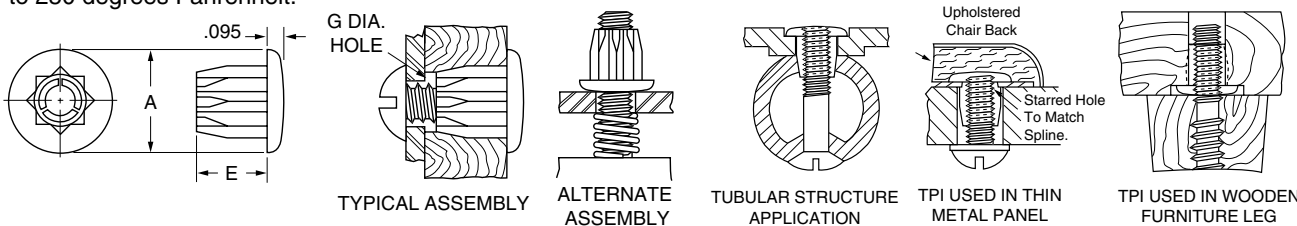

SPAENAUR No.	Tinnerman® Manufacturer's No.	Screw Size	Pre-tapped	Average Test Values				A	E	G Hole Dia.
				Prevailing Torque (in. lbs.)	Destruct. Torque (in. lbs.)	Install. Torque (in. lbs.)	Tensile Load Limit			
086-259	C61918AF-801	8B	No	—	30	25	300	.64	.44	.375

Contact Sales Desk For Package Quantities

Inch

Tinnerman® Dart Clips

Pouce

Clips sapins Tinnerman^{MD}

BUTTON HEAD DARTS Plastic Fasteners

These versatile button-head darts offer many diversified application possibilities. They may be used for light retention, as bumpers, hole plugs, bearings or spacers. Ideally suited for simplified assembly of products shipped knocked-down for consumer assembly. Available in different materials, head types and panel ranges.

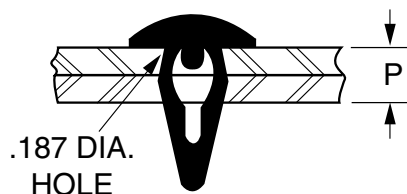

TYPICAL ASSEMBLY

MATERIAL: Acetal, Nylon or Polypropylene

FINISH: Natural or Black.

DESIGN VARIATIONS:

Parts shown as standard or with design variations are available only in that particular design.

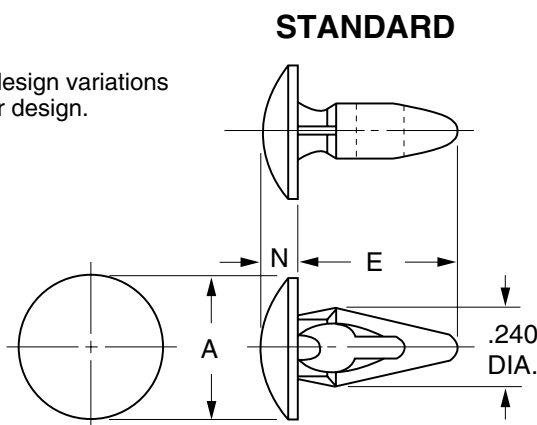

DESIGN VARIATIONS

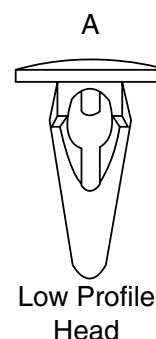

The INCH dimensions of the listed parts are reference dimensions only. For complete design information, please request a blueprint.

SPAENAUR No.	Manufacturer's No.	P Panel Range	Design Variation	A	N	E	Material	Colour
086-213	C61546AG-028-805	.035-.100	Std.	.420	.100	.475	Acetal	Black
086-204	C61546AD-028-801		Std.	.420	.100	.475	Polypropylene	Natural
086-205	C61782AA-060-801	.060-.100	A	.445	.062	.595	Nylon	Natural
086-207	C61622AA-130-801	.130-.180	Std.	.420	.100	.555	Nylon	Natural
086-208	C61622AG-130-801		Std.	.420	.100	.555	Acetal	Natural
086-F41-1W	C61375AA-170-801	.170-.234	A	.420	.050	.595	Nylon	Natural
086-215	C61375AA-170-805		A	.420	.050	.595	Nylon	Black

Contact Sales Desk For Package Quantities

CATALOG 14 SPAENAUR



Fasteners Right Now®

Tinnerman® PT Style Pushnuts & Applicator Tools

Inch and Metric

Écrous capuchons style PT et outils d'installation Tinnerman^{MD}

Pouce et Métrique

Tinnerman®

Sizes, Tooth Designs, Dimensions and Performance

PUSHNUTS "PT" Style

INCH SIZES

BOLT DIA.	SPAENAUR No.	DESIGN	DIMENSIONS			PERFORMANCE		PKG QTY.
			DIA. D	HGT. H	MATL. THICK.	PUSH-ON FORCE LBS. (Max.)	HOLDING STRENGTH LBS. (Min.)	
#6	177-H04-1P	3	11/32"	.047"	.010"	17	40	100
#10	177-061	3	7/16"	.065"	.012"	26	65	100
1/4"	177-H05-1Y	1	1/2"	.078"	.010"	17	65	100
3/8"	177-063	2	25/32"	.093"	.015"	38	150	100

METRIC SIZES

PUSHNUTS "PT" Style

mm	Spaenaur No.	Design	mm	mm	mm	Newtons	Newtons	PKG QTY.
M6	▲177-303MZ	1	12.7	1.91	.25	111.2	400.5	100
M6.3	177-304	1	12.7	1.98	.25	111.2	400.5	100
M8	177-H08-1T	1	15.9	2.08	.33	155.7	445.0	100
M10	■177-H03-1A	2	19.8	2.36	.38	155.7	667.5	100

▲ Mechanical Zinc Finish ■ 177-306MZ, Mechanical Zinc Finish

Applicator Tools for above PUSHNUTS listed below.

Tools for Tinnerman®

PKG QTY. 1

SPAENAUR No. Tool	Fastener	Design No.	Overall Length L	Dia. D	Stud Clearance Depth
876-288	177-069	1	3/4"	7/16"	3/4"
876-289	177-070	2	3"	1/2"	1-1/2"
876-290	177-072	2	3"	5/8"	1-1/2"
876-287	177-077	1	3"	7/16"	1-1/4"
876-294		4	3"	1/2"	.635"

NOTE: Any tool will fit any fastener listed between same horizontal lines. See fasteners on next page. All tools have magnetized shanks.

For more Pushnuts Tools, visit page C102

Inch

Tinnerman® Arched Rectangular Pushnuts

Pouce

Écrous capuchons rectangulaires arqués Tinnerman^{MD}

Tinnerman® Arched Rectangular/round types

Spring Steel Material, with protective finish



Style PH



Style PA



Style PZ



Style PV

*Recommended diameter tolerance of stud for PH and PZ fasteners is ±.005"; for PA fasteners, +.002" and -.003". Surface hardness of stud must not exceed Rockwell 30T-78. Nickel-chrome plating on studs for PH fasteners must not exceed .001". Nickel-chrome plating or other hard finishes not recommended on steel studs for PA fasteners.

Arched types provide spring tension or "take-up" to compensate for unavoidable slack. Round styles require minimum space. These styles develop optimum clamping strength only when the body arch is substantially flattened against the work. Therefore, the bearing surface must be hard enough for the fastener edge to slide on, strong enough to resist breaking, and rigid enough not to yield.

See page C100 for Tinnerman Tools

PKG QTY. 100

STYLE PH	DIMENSIONS				Wgt. Lbs./M	To Fit Smooth Round Stud Diameter (Inch)*	SPAENAUR No.	PERFORMANCE		
	Steel Thick. (Inch)	Width W (Inch)	Length L (Inch)	H (Inch)				In Pounds		
								Push-On Force	Seat. Force	Minumum Holding Strength
	.015	.375	.672	.116	1.0	1/8 (.125)	177-077	45	70	130
	.013	.375	.625	.107	0.8	3/16 (.188)	▲177-078	20	50	170

▲ STYLE PZ

STYLE PA	DIMENSIONS					Wgt. Lbs./M	To Fit Smooth Round Stud Diameter (Inch)*	SPAENAUR No.	PERFORMANCE		
	Design No.	Steel Thick. (Inch)	Total Height H (Inch)	Washer Dia.					Push On Force	Seat. Force	Minumum Holding Strength
				Inside F (Inch)	Outside D (Inch)						
	1	.009	.073	.228	3/8	0.3	1/8 (.125)	177-H12-1W	15	15	130
	1	.013	.078	.228	3/8	0.4	1/8 (.125)	177-067	26	25	350
	2	.010	.087	.320	7/16	0.4	3/16 (.188)	177-068	10	50	200
	2	.012	.095	.388	17/32	0.7	1/4 (.250)	177-070	25	60	400
	2	.017	.103	.388	17/32	1.0	1/4 (.250)	177-071	30	115	600
	2	.013	.058	.320	7/16	0.5	5/32 (.156)	◆177-079	25	—	180
	2	.021	.114	.456	5/8	1.5	5/16 (.312)	177-084	60	120	900

◆ Flat Round Type

STYLE PV	ZINC PLATED										
	—	.015	.083	.750	15/16	2.6	1/4 (.250)	177-081	14	—	100

CATALOG 14

SPAENAUR