

Inch
Pouce



Slam Latches & Paddle Handles

Loquets à ressort et loquets à palette

SLEEK, CONTEMPORARY ... Eclipse® adds value to cabinets, consoles, panels, controls enclosures, etc., with SEVEN different styles from which to choose. Low profile appearance.

THE ECLIPSE® LATCHES are available from stock in non-locking and key-locking versions (furnished with 2 keys).

Photographs shown are actual size. Latches available in BLACK MATTE FINISH.

LATCH MATERIALS

HOUSINGS and HANDLES — Made of thermoplastic alloy. A polycarbonate-based polymer blend providing strength, light weight and excellent heat and chemical resistance.

SLIDE BOLT and PIVOT LEVERS — Made of nylon with 30% fiberglass reinforcement for wear resistance and a smooth operation.

METAL STAMPINGS and FASTENERS — 300 Series Stainless Steel.

KEY CYLINDERS — Zinc die cast.

FEATURES & BENEFITS

Installation is fast with the use of the mounting bracket and (2) screws, which are provided. No external fasteners. No weld marks to mar finish. Eclipse® latches can be assembled on finished panels. An oil-resistant flange gasket is also provided. All Eclipse® series latches fit the same size cutout.

**Pull Ring Latch
(Slam Latch)**



The Eclipse® pull ring handle offers a simple, one-finger activation.

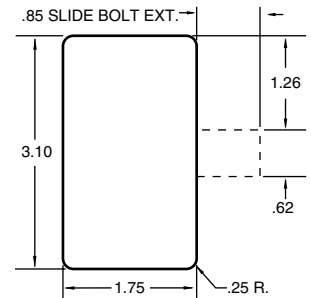
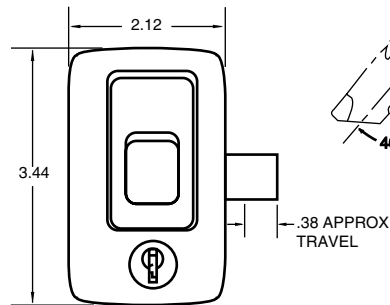

Suggested Cutout

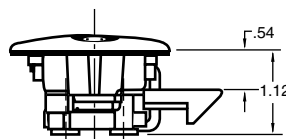
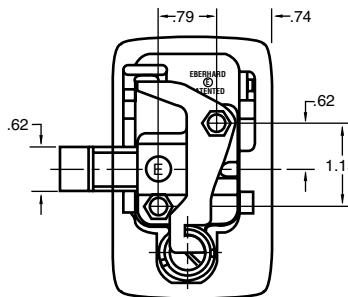

Paddle Handle

same as 099-400 (At left) except supplied with paddle handle instead of pull ring.



(Illustration half size)

099-400 Non-Locking

Mfr. #ECL-130-P8

PKG QTY. 1

099-410 Non-Locking

Mfr. #ECL-730-P8

099-411 Key Locking

Mfr. #ECL-730-KP8

CATALOG 14

SPAENAUR

Inch

Pouce



Rotary Slam Latch / Folding Tee Handle

Loquet à ressort rotatif / poignée en T pliante

Three methods of release.

Compact Rotary Slam Latch

SPAENAUR No. 099-153 (Mfr. #200)
STEEL - Electro Zinc Finish

SPAENAUR No. 099-B09-1C (Mfr. #200SS)
304 STAINLESS STEEL

Latch Pawls are Carbon Steel with black coating.

- Recommended for small hoods, lids, doors, or panels.
- Universal mounting.
- Easily mounted with two 1/4" bolts.
- Receives any 3/8" dia. striker.

● Suggested maximum load 100 lbs.

WARNING
This product must not be used for personal restraint applications.

Folding-T Handle with attached stamped steel escutcheon. A concealed stainless steel spring holds the zinc die-cast handle in the folded position.

5/16" square shank.
1-13/32" long

SPAENAUR No. 099-197
STEEL Zinc-plated
PKG QTY. 1

Mfr. # 4855-A

Weight: 0.4 lbs.

Rotary Paddle Lock (Slam Latch)

The new Key-locking rotary paddle lock was designed for a wide variety of applications requiring a durable means of positive latching, incorporating the industry standard paddle latch configuration with the positive latching features of our two-stage rotary.

SPAENAUR No. 099-194 STAINLESS STEEL
(Mfr. # 3-4373SS) Bright Polished

099-194 includes four 11/64" dia. mounting holes on 3-3/4" x 3-13/16" hole centres.

Non-Locking and Mounting Hole Versions are available.

PKG QTY. 1

Weight: 1.37 lbs.

CATALOG 14 SPAENAUR

Inch

Pouce



Rotary Latches / Flush Mount Paddle Handle

Loquets rotatifs / poignée à palette affleurante

ZINC PLATED

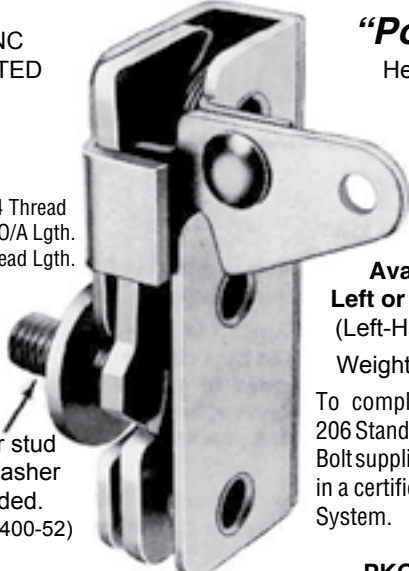

7/16"-14 Thread
1-9/16" O/A Lgth.
3/4" Thread Lgth.

Striker stud and Washer included.
(Mfr. #2-400-52)

"Positive"
Heavy-duty

(Mfr. #400)

Available in Left or Right-Hand
(Left-Hand Shown)

Weight: 1 lb. each

To comply with FMVSS 206 Standards, the Striker Bolt supplied must be used in a certified FMVSS Door System.

Rotary Latching Points

Mounts through the pivot points of the mechanism rather than through the holes of the case extension.

This latch can be used on cab and other vehicle door applications to which the FMVSS 206 applies. It can also be used on any other enclosure application that would benefit from positive latching.

When the door is closed, the gripping member of the latch captures the shank of the hex-headed striker stud horizontally, vertically, and axially. The design affords easy trip-release action, positive gripping, and smooth opening and closing. Both primary and secondary latching capabilities are inherent in the design.

SPAENAUR No.	Style	Mfr. #
099-030	Right-Hand	400R with 2-400-52
099-031	Left-Hand	400L with 2-400-52
099-218	Striker Stud with Washer	2-400-52

PKG QTY. 1

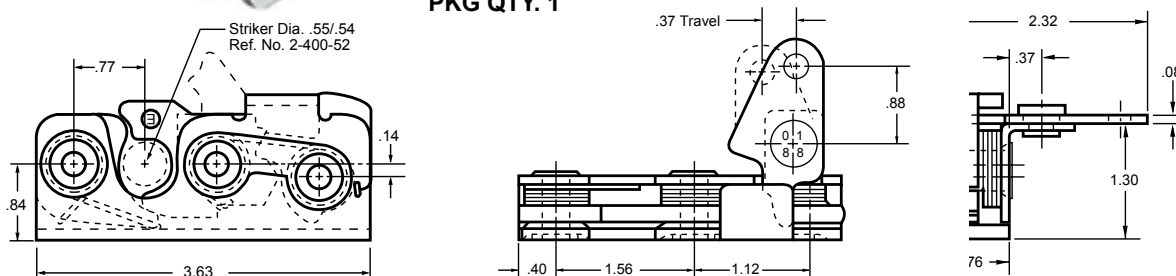

Flush-Mounted Paddle Handles - Cable Actuating

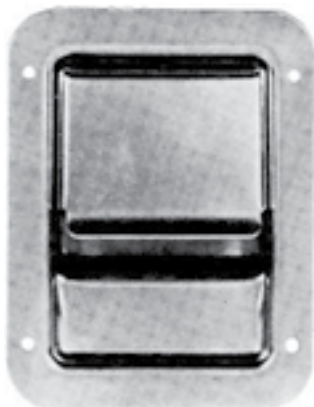

ZINC PLATED

SPAENAUR No.	Style	Mfr. #
099-026	Key-Locking	250
099-027	Non Key-Locking	249
099-040	Locking Cylinder only	4901-61
116165	Replacement Key	-

(Front view shown)

099-027
Non Key-Locking
Weight:
1 lb. 1 oz. each

Designed to activate remote latching points.

See page L56 for typical installation.

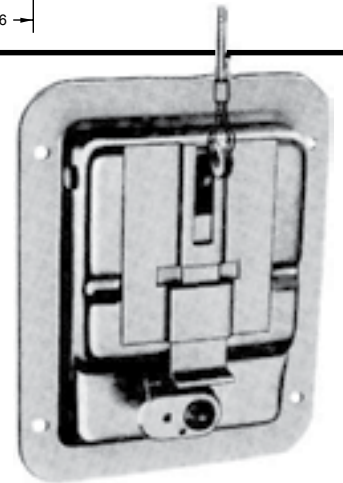

(Rear view shown)

099-026
Key-Locking

Keyed to differ - With one key
Replacement key cylinder
099-040

Weight: 1 lb. 2-1/2 oz. each

WARNING
This product must not be used for personal restraint applications.

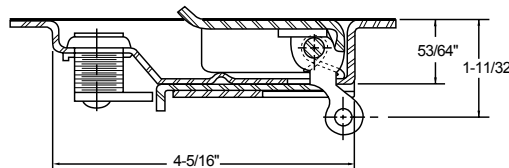
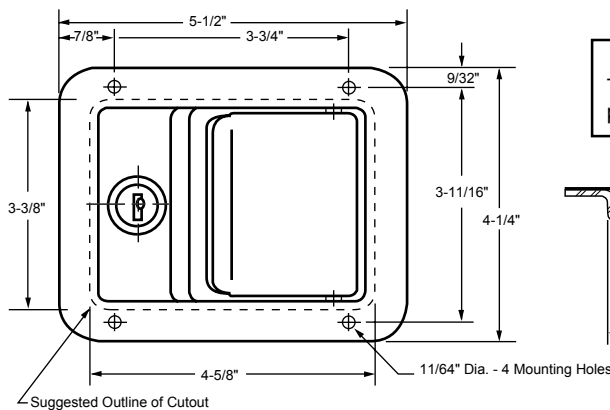

PKG QTY. 1

NOTE
Drawings and dimensions on this page are for reference only. For manufacturing production or tooling purposes, obtain current engineering print from SPAENAUR.