

Inch and Metric
Pouce et Métrique



Socket Sets / Extensions / Adapters / 6 Point Socket
Ensembles de douilles / Rallonges / Adaptateurs / Douille à 6 pointes

1/4
inch



SPAENAUR No. 991-229
(HAZET No. 854)

-with Screwdriver Bits-

30 parts

SPAENAUR No's.

	991-210
	991-216
	991-217
	991-218
	991-220
	991-221

187 x 125 x 39 mm

6 Point Sockets				Hex Bits		Torx Bits		
SPAENAUR No.	Sizes	SPAENAUR No.	Sizes	SPAENAUR No.	Sizes	SPAENAUR No.	Sizes	
991-142	4	991-149	9	991-183	3	991-201	1	
991-144	5	991-150	10	991-184	4	991-202	2	
991-145	5.5	991-151	11	991-185	5	Torx Bits		
991-146	6	991-152	12	991-186	6		991-205	1
991-147	7	991-153	13	991-187	8		991-206	2
991-148	8	991-154	14					

Extensions

DIN 3123, ISO 3316
Chrome-Vanadium
1" ■, 1" □, drive
■ with locking device,
□ with bolt for locking device

1
inch

**Chrome-Plated
Polished**

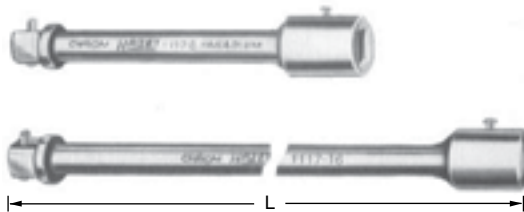

SPAENAUR No.	HAZET No.	L		Ø mm
		mm	inch	
991-876	1117-8	200	8	28
991-877	1117-16	400	16	28

Universal Joint

Chrome-Vanadium
1" ■, 1" □, drive (DIN 3120)
■ with locking device,
□ with bolt for locking device

Chrome-Plated



SPAENAUR No.	HAZET No.	L		Ø mm
		mm	inch	
991-878	1121	143	5-3/4	48

Adapter

DIN 3123, ISO 3316
Chrome-Vanadium
1" □ drive,
■ with ball fitting and locking device,
□ with bolt for locking device

Chrome-Plated



SPAENAUR No.	HAZET No.	L mm	inch	
			■	□
991-879	1158-2	70	3/4	1

6 Point Spark Plug Sockets

Foreign patents
Chrome-Vanadium
3/8" □ drive (DIN 3120)

3/8
inch

**Chrome-Plated
Polished**

Long pattern, with permanent magnet and guide bushing
Centres all plugs automatically.



SPAENAUR No. 993-978
Replacement Magnet for 991-372

SPAENAUR No. 993-977
Replacement Magnet for 991-373

SPAENAUR No.	HAZET No.	s		L mm	d ₁ mm	d ₂ mm	t mm
		mm	inch				
991-372	880 Mg T	20.8	13/16	64	27.4	22.5	9.0
991-373	880 A Mg T	16.0	5/8	64	21.6	21.7	9.0

6 Point Sockets

Douilles à 6 pointes



Inch and Metric
Pouce et Métrique

6 Point Sockets

DIN 3124, ISO 2725
Chrome-Vanadium
3/8" □ drive,

3/8
inch

Chrome-Plated
Polished



6 Point Sockets

DIN 3124, ISO 2725
Chrome-Vanadium
3/8" □ drive,

Chrome-Plated
Polished

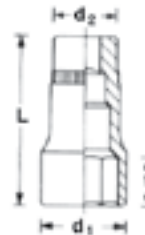

Long Pattern

SPAENAUR No.	HAZET No.	mm	L mm	d ₁ mm	d ₂ mm	t mm
*991-236	880-6	6	24.0	10.0	17.0	6.2
991-237	880-7	7	24.0	10.5	17.0	6.2
991-238	880-8	8	24.0	11.8	17.0	6.2
991-239	880-9	9	24.0	13.0	17.0	6.2
991-240	880-10	10	25.0	14.4	17.0	7.2
991-241	880-11	11	26.0	15.8	17.5	8.2
991-242	880-12	12	27.0	17.0	18.5	9.2
*991-243	880-13	13	27.5	18.7	17.0	9.7
*991-244	880-14	14	29.5	19.8	17.5	11.7
*991-245	880-15	15	29.5	21.1	18.0	11.7
991-246	880-16	16	29.5	22.1	18.0	11.7
991-247	880-17	17	29.5	23.3	18.5	11.7
*991-248	880-18	18	31.5	24.8	19.0	13.5
991-249	880-19	19	31.5	25.8	19.5	13.5
991-250	880-20	20	31.5	26.8	21.0	13.5
991-251	880-21	21	31.5	28.3	22.5	13.0
*991-252	880-22	22	33.8	30.3	23.5	16.0

SPAENAUR No.	HAZET No.	mm	L mm	d ₁ mm	d ₂ mm	t mm
*991-262	880 Lg-9	9	54	13.0	17.0	10.0
*991-263	880 Lg-10	10	54	14.4	17.0	10.0
*991-264	880 Lg-11	11	54	15.8	17.2	11.0
*991-265	880 Lg-12	12	54	17.0	18.5	11.0
*991-266	880 Lg-13	13	54	18.4	18.5	12.0
*991-267	880 Lg-14	14	54	19.5	19.5	15.0
*991-268	880 Lg-15	15	60	20.8	19.5	15.0
*991-269	880 Lg-16	16	60	21.8	18.5	16.0
*991-270	880 Lg-17	17	60	23.0	18.5	16.0
*991-271	880 Lg-18	18	66	24.4	20.0	20.0
*991-272	880 Lg-19	19	66	25.5	20.0	20.0
991-273	880 Lg-20	20	70	26.6	21.0	22.0
♦991-274	880 Lg-20.8	20.8	70	27.4	21.0	16.5
991-275	880 Lg-21	21	70	28.0	22.0	22.0
991-276	880 Lg-22	22	70	29.6	21.0	22.0

* not according to DIN
♦ with rubber insert for spark plugs

*not according to DIN

Width Across Flats according to ISO 691

Inch Sizes

991-253	880A-1/4	1/4	24.0	10.0	17.0	6.2
991-254	880A-5/16	5/16	24.0	11.8	17.0	6.2
991-255	880A-3/8	3/8	25.0	13.8	17.0	7.2
991-256	880A-7/16	7/16	26.0	15.8	17.5	8.2
991-257	880A-1/2	1/2	27.5	18.7	17.0	9.7
991-258	880A-9/16	9/16	29.5	20.1	17.5	11.7
991-259	880A-5/8	5/8	29.5	22.1	18.0	11.7
991-260	880A-11/16	11/16	29.5	23.8	18.5	11.7
991-261	880A-3/4	3/4	31.5	25.8	19.5	13.5

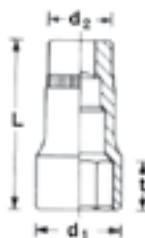

Inch Sizes

991-277	880A Lg-3/8	3/8	54	13.8	17.0	10.0
991-278	880A Lg-7/16	7/16	54	15.8	17.2	11.0
991-280	880A Lg-9/16	9/16	60	19.8	19.5	15.0
991-281	880A Lg-19/32	19/32	60	20.8	19.5	15.0
991-282	880A Lg-5/8	5/8	60	21.8	18.5	16.0
991-283	880A Lg-11/16	11/16	66	23.5	19.0	20.0
991-284	880A Lg-3/4	3/4	66	25.5	19.0	20.0
991-286	880A Lg-7/8	7/8	70	29.6	22.0	22.0

N

6 Point Sockets

Douilles à 6 pointes



Metric
Métrique

6 Point Sockets

DIN 3124, ISO 2725

Chrome-Vanadium

1/2" □ drive,

1/2
inch

Chrome-Plated
Polished

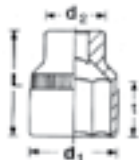

SPAENAUR No.	HAZET No.	mm	L mm	d ₁ mm	d ₂ mm	t mm
*991-465	900-8	8	38.0	12.0	22.0	7.5
*991-466	900-9	9	38.0	13.5	22.0	8.5
991-467	900-10	10	38.0	14.9	22.0	10.5
991-468	900-11	11	38.0	16.4	22.0	10.5
991-469	900-12	12	38.0	17.5	22.0	11.0
991-470	900-13	13	38.0	18.8	22.0	11.0
991-471	900-14	14	38.0	20.3	22.0	11.5
991-472	900-15	15	38.0	21.5	23.0	11.5
991-473	900-16	16	38.0	22.7	23.6	12.5
*991-474	900-17	17	38.0	24.6	22.0	12.5
991-475	900-18	18	38.0	25.4	22.4	14.0
*991-476	900-19	19	38.0	26.7	23.0	14.0
991-477	900-20	20	38.0	27.8	24.0	14.0
991-478	900-21	21	38.0	29.0	25.0	14.0
991-479	900-22	22	41.5	30.4	26.0	17.5
991-480	900-23	23	41.5	31.4	26.0	17.5
991-481	900-24	24	44.0	32.6	26.0	20.0
991-482	900-25	25	44.0	33.9	26.0	20.0
991-483	900-26	26	44.0	35.1	24.0	20.0
991-484	900-27	27	46.0	36.2	25.0	21.0
991-485	900-28	28	47.0	37.5	26.0	22.0
*991-486	900-29	29	50.0	38.7	27.0	25.0
991-487	900-30	30	50.0	40.1	28.0	25.0
991-488	900-32	32	50.0	42.3	28.0	24.0

* not according to DIN

6 Point Sockets

DIN 3124, Deep Sockets

Chrome-Vanadium

1/2" □ drive,

Chrome-Plated
Polished

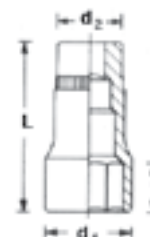

SPAENAUR No.	HAZET No.	mm	L mm	d ₁ mm	d ₂ mm	t mm
*991-504	900 Lg-12	12	82	17.5	22.0	11
991-505	900 Lg-13	13	82	18.8	22.0	12
991-506	900 Lg-14	14	82	19.9	22.5	15
991-507	900 Lg-15	15	82	21.5	23.2	15
991-508	900 Lg-16	16	82	22.7	23.6	15
991-509	900 Lg-17	17	82	24.1	23.6	15
*991-510	900 Lg-18	18	82	24.6	23.6	15
991-513	900 Lg-21	21	82	28.6	24.5	18
991-514	900 Lg-22	22	82	30.4	25.0	21
991-515	900 Lg-24	24	82	32.6	27.5	24
991-516	900 Lg-26	26	82	35.1	29.5	24
991-517	900 Lg-27	27	82	36.3	30.0	27
991-518	900 Lg-30	30	82	40.1	33.0	30

* not according to DIN

N



See page N46 for Hazet Torque Wrenches



N24

Inch and Metric
Pouce et Métrique



12 Point Sockets
Douilles à 12 pointes

12 Point Sockets

DIN 3124, ISO 2725
Chrome-Vanadium
1/2" □ drive,

1/2
inch

Chrome-Plated
Polished

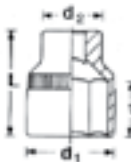

SPAENAUR No.	HAZET No.	mm	L mm	d ₁ mm	d ₂ mm	t mm
*991-528	900 Z-8	8	38.0	12.0	22.0	7.5
*991-529	900 Z-9	9	38.0	13.5	22.0	8.5
991-530	900 Z-10	10	38.0	14.9	22.0	10.5
991-531	900 Z-11	11	38.0	16.4	22.0	10.5
991-532	900 Z-12	12	38.0	17.5	22.0	11.0
991-533	900 Z-13	13	38.0	18.8	22.0	11.0
991-534	900 Z-14	14	38.0	20.3	22.5	11.5
991-535	900 Z-15	15	38.0	21.5	23.2	11.5
991-536	900 Z-16	16	38.0	22.7	23.6	12.5
*991-537	900 Z-17	17	38.0	24.6	22.0	12.5
991-538	900 Z-18	18	38.0	25.4	22.4	14.0
*991-539	900 Z-19	19	38.0	26.7	23.0	14.0
991-540	900 Z-20	20	38.0	27.8	24.0	14.0
991-541	900 Z-21	21	38.0	29.0	25.0	14.0
991-542	900 Z-22	22	41.5	30.4	26.0	17.5
991-543	900 Z-23	23	41.5	31.4	26.0	17.5
991-544	900 Z-24	24	44.0	32.6	26.0	20.0
991-545	900 Z-25	25	44.0	33.9	24.8	20.0
991-546	900 Z-26	26	44.0	35.1	24.0	20.0
991-547	900 Z-27	27	46.0	36.2	25.0	21.0
991-548	900 Z-28	28	47.0	37.5	26.0	22.0
*991-549	900 Z-29	29	50.0	38.7	27.0	25.0
991-550	900 Z-30	30	50.0	40.1	28.0	25.0
991-551	900 Z-32	32	50.0	42.3	28.0	24.0
*991-552	900 Z-33	33	50.0	43.6	28.0	24.0

* not according to DIN

Width Across Flats according to ISO 691

Inch Sizes

991-553	900 AZ-3/8	3/8	38.0	14.5	22.0	10.5
991-554	900 AZ-7/16	7/16	38.0	16.4	22.0	10.5
991-555	900 AZ-1/2	1/2	38.0	18.3	22.0	11.0
991-556	900 AZ-9/16	9/16	38.0	20.5	22.5	11.5
991-557	900 AZ-19/32	19/32	38.0	21.5	23.2	11.5
991-558	900 AZ-5/8	5/8	38.0	22.7	23.6	12.5
991-559	900 AZ-11/16	11/16	38.0	24.6	22.0	12.5
991-560	900 AZ-3/4	3/4	38.0	26.8	23.0	14.0
991-561	900 AZ-25/32	25/32	38.0	27.8	24.0	14.0
991-562	900 AZ-13/16	13/16	38.0	28.6	25.0	14.0
991-563	900 AZ-7/8	7/8	41.5	30.4	26.0	17.5
991-564	900 AZ-15/16	15/16	44.0	32.6	26.0	20.0
991-565	900 AZ-31/32	31/32	44.0	33.4	24.6	20.0
991-566	900 AZ-1	1	44.0	34.6	24.8	20.0
991-567	900 AZ-1-1/16	1-1/16	46.0	36.3	25.0	21.0
991-568	900 AZ-1-1/8	1-1/8	47.0	38.2	26.5	22.0
991-569	900 AZ 1-3/16	1-3/16	50.0	40.1	28.0	25.0
991-570	900 AZ-1-1/4	1-1/4	50.0	42.3	28.0	24.0

12 Point Sockets

DIN 3124,
Chrome-Vanadium
1/2" □ drive,

Chrome-Plated
Polished

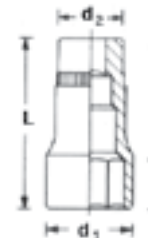

Deep Sockets

SPAENAUR No.	HAZET No.	mm	L mm	d ₁ mm	d ₂ mm	t mm
*991-571	900 TZ-12	12	82	17.5	22.0	11
991-572	900 TZ-13	13	82	18.8	22.0	12
991-573	900 TZ-14	14	82	19.9	22.5	15
991-574	900 TZ-15	15	82	21.5	23.2	15
991-575	900 TZ-16	16	82	22.7	23.6	15
991-576	900 TZ-17	17	82	24.1	23.6	15
*991-577	900 TZ-18	18	82	24.6	23.6	15
*991-578	900 TZ-19	19	82	26.8	26.0	18
◆991-579	900 TZ-20.8	20.8	82	28.5	24.5	18
991-580	900 TZ-21	21	82	28.6	24.5	18
991-581	900 TZ-22	22	82	30.4	25.0	21
991-582	900 TZ-24	24	82	32.6	27.5	24
991-584	900 TZ-27	27	82	36.3	30.0	27
991-585	900 TZ-30	30	82	40.1	33.0	30

*not according to DIN

◆ with rubber insert for spark plugs

CATALOG 14 SPAENAUR

SPAENAUR
Fasteners Right Now®

N

Breaker Bars / Ratchet / 6 Point Socket

Poignées articulées / Clé à rochet / Douilles à 6 pointes



Inch and Metric
Pouce et Métrique

Flexible Handles

DIN 3122, ISO 3315

Chrome-Vanadium

1/2" ■ drive,

with HAZET-ergonomic® plastic handle, black (protected by design patent)

Chrome-Plated



SPAENAUR No.	HAZET No.	L	
		mm	inch
991-625	914-15	396	15-1/2
*991-626	914-18	472	18-3/4

* not according to DIN

Sliding T-Handle

DIN 3122, ISO 3315

Chrome-Vanadium

1/2" ■ drive

Chrome-Plated Polished

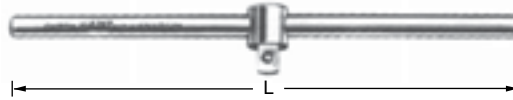

SPAENAUR No.	HAZET No.	L	
		mm	inch
991-627	915	298	12

Reversible Ratchets with hinge joint

Chrome-Vanadium

1/2" ■ drive (DIN 3120),

Polished

with HAZET-ergonomic® plastic handle, black (protected by design patent)
32 teeth



Short Pattern

SPAENAUR No.	HAZET No.	L	
		mm	inch
991-632	916 GK	270	10-1/2

Chrome-Plated

1/4" Drive 6 Point Sockets

DIN 3124, ISO 2725

Chrome-Vanadium

1/4" □ drive

Chrome-Plated Polished



1/4 inch

SPAENAUR No.	HAZET No.	mm	L mm	d ₁ mm	d ₂ mm	t mm
991-142	850-4	4	25	6.8	11.0	3.7
991-143	850-4.5	4.5	25	7.0	11.0	4.2
991-144	850-5	5	25	8.0	11.0	4.1
991-145	850-5.5	5.5	25	8.5	11.0	4.6
991-146	850-6	6	25	9.0	11.0	5.1
991-147	850-7	7	25	10.5	11.5	5.6
*991-148	850-8	8	25	11.5	12.5	6.3
991-149	850-9	9	25	13.0	11.5	7.3
991-150	850-10	10	25	14.0	12.5	7.3
991-151	850-11	11	25	15.5	14.0	8.3
991-152	850-12	12	25	17.0	15.0	9.3
991-153	850-13	13	25	18.0	15.0	9.3
991-154	850-14	14	25	19.5	16.0	10.8

*not according to DIN

Deep Sockets

Sizes 4 - 5.5 = DIN 3124

SPAENAUR No.	HAZET No.	L mm	d ₁ mm	d ₂ mm	t mm
991-165	850 Lg-4	50	6.7	11.0	3.8
991-166	850 Lg-5	50	7.9	11.0	4.4
991-167	850 Lg-5.5	50	8.5	11.0	4.7
991-168	850 Lg-6	50	9.2	11.0	5.0
991-169	850 Lg-7	50	10.4	11.0	5.5
991-170	850 Lg-8	50	11.6	11.6	6.0
991-171	850 Lg-9	50	13.0	13.0	6.5
991-172	850 Lg-10	50	14.2	14.2	7.0
991-173	850 Lg-11	50	15.5	15.5	7.5
991-174	850 Lg-12	50	16.8	16.8	8.0
991-175	850 Lg-13	50	18.0	18.0	8.5

Inch Sizes

SPAENAUR No.	HAZET No.	Inch	L mm	d ₁ mm	d ₂ mm	t mm
991-155	850A-3/16	3/16	25	8.0	11.0	4.2
991-156	850A-7/32	7/32	25	8.5	11.0	4.6
991-157	850A-1/4	1/4	25	9.5	11.0	5.1
991-158	850A-9/32	9/32	25	10.5	11.5	5.6
991-159	850A-5/16	5/16	25	11.5	12.5	6.3
991-160	850A-11/32	11/32	25	13.0	11.5	7.3
991-161	850A-3/8	3/8	25	14.0	12.5	7.3
991-162	850A-7/16	7/16	25	15.5	14.0	8.3
991-163	850A-1/2	1/2	25	18.0	15.0	9.3
991-164	850A-9/16	9/16	25	19.5	16.0	10.8

N

Inch and **Metric**
Pouce et **Métrique**



6 Point / Hex Drive - Socket Bits / Breaker Bar

Embout à 6 pointes / à prise hexagonale – tête creuse / Poignée articulée

6 Point Sockets

DIN 3124, ISO 2725
Chrome-Vanadium
3/4" □ drive,
With locking device

Chrome-Plated
Polished

3/4
inch



SPAENAUR No.	HAZET No.	mm	L mm	d ₁ mm	d ₂ mm	t mm
*991-752	1000-19	19	52.0	28.0	33.2	14.2
*991-753	1000-22	22	52.0	32.0	33.2	13.5
991-755	1000-24	24	52.0	34.0	36.0	16.0
991-758	1000-27	27	54.0	38.0	35.0	18.8
991-761	1000-30	30	55.0	42.0	36.0	21.0
991-762	1000-32	32	58.0	44.5	36.0	23.4
*991-763	1000-33	33	59.0	46.0	36.0	23.9
991-764	1000-34	34	60.0	47.5	36.0	24.8
991-766	1000-36	36	61.5	49.5	36.0	25.7
*991-767	1000-38	38	65.0	52.5	38.0	28.3
991-768	1000-41	41	68.5	55.5	39.0	31.2
*991-769	1000-42	42	70.0	57.5	41.0	31.2
991-770	1000-46	46	73.0	62.0	44.0	34.0
991-771	1000-50	50	65.0	67.0	42.0	33.5
*991-772	1000-55	55	70.0	73.5	42.0	36.0
*991-773	1000-60	60	70.0	80.0	42.0	36.0

* not according to DIN/ISO

Span of jaws ISO 691 Inch Sizes

▲	HAZET No.	mm	mm	mm	mm	
▲991-812	1000 AZ-15/16	15/16	52.0	34.0	36.0	16.0
▲991-815	1000 AZ-1-1/8	1-1/8	54.0	40.0	36.0	19.8
▲991-822	1000 AZ-1-5/8	1-5/8	68.0	55.5	39.0	31.2
▲991-826	1000 AZ-1-7/8	1-7/8	65.0	64.0	42.0	33.5
▲991-827	1000 AZ-2	2	65.0	68.0	42.0	33.5

▲ 12 Point Socket

Above sizes are also available in 12 point sockets in **Metric** and **Inch**.

Hex Sockets

Chrome-Vanadium
For hex socket head screws.
3/4" □ drive (DIN 3120)
with locking device

3/4
inch



◆ Impact Hex Sockets - Plain Finish

SPAENAUR No.	HAZET No.	s mm	L ₁ mm	L ₂ mm	d mm
991-828	1010-14	14	16.7	54.5	36
991-829	1010-17	17	19.7	54.5	36
991-830	1010-19	19	21.7	56.5	36
991-831	1010-22	22	24.7	56.5	36
◆877-251	—	24	20	70	44
◆877-252	—	27	20	70	44

Handle Bar

Chrome-Vanadium
with locking device

Chrome-Plated

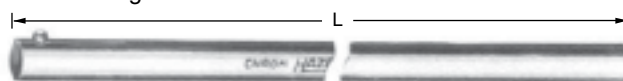

SPAENAUR No.	HAZET No.	L mm	L inch	Ø mm
991-832	1014	500	19-1/2	20

Sliding Part

Chrome-Vanadium
3/4" ■ drive
To be fixed at Handle Bar
Chrome-Plated



991-833	1015-1	60	2-3/8	—
---------	--------	----	-------	---

Handle Bar with Sliding Part

Chrome-Vanadium
991-832 + 991-833 = Sliding T-Handle

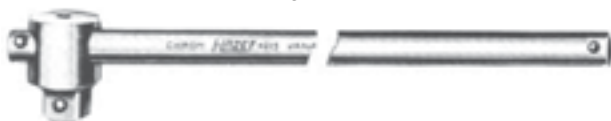

SPAENAUR No.	HAZET No.	L mm	L inch	Ø mm
991-834	1015/2	500	19-1/2	20

Universal Joint

DIN 3123, ISO 3316
Chrome-Vanadium
3/4" ■, 3/4" □ drive,
■ with ball fitting and locking device
□ with bolt for locking device

Chrome-Plated



SPAENAUR No.	HAZET No.	L mm	L inch	Ø mm
991-840	1021	105	4	40

Ratchet / Adapters / 12 Point Sockets / Extensions

Clé à rochet / Adaptateurs / Douilles à 12 pointes / Rallonges



Inch and Metric
Pouce et Métrique

Ratchet Head

Chrome-Vanadium
3/4" ■ (DIN 3120),
■ with ball fitting and locking device,
shank with bolt for locking device
32 teeth



Chrome-Plated

SPAENAUR No.	HAZET No.	L		Ø mm
		mm	inch	
991-835	1016	165	6-1/2	—

Extensions

Chrome-Vanadium
3/4" ■, 3/4" □ drive,
■ with ball fitting and locking device
□ with bolt for locking device

Chrome-Plated
Polished

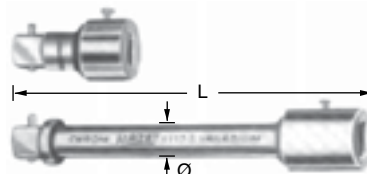

SPAENAUR No.	HAZET No.	L		Ø mm
		mm	inch	
*991-837	1017-3	75	3	25
991-838	1017-8	200	8	20

*not according to DIN
991-838 = DIN 3123, ISO 3316

Adapters

DIN 3123, ISO 3316
Chrome-Vanadium
3/4" □ drive
with ball fitting and locking device



Chrome-Plated

SPAENAUR No.	HAZET No.	L mm	□ inch	
			■	□
991-841	1058-1	60	1	3/4
991-842	1058-2	52.3	1/2	3/4

DIN 3123, ISO 3316



991-839	1018	400	16	22
---------	------	-----	----	----

12 Point Sockets

Chrome-Vanadium
For injection nozzles on diesel engines
VW-Audi, Mercedes-Benz, Opel, Ford,
Peugeot-Talbot, Volvo, Toyota, Mazda,
Nissan, Mitsubishi, Daihatsu,
MB-No. 001 589 65 09 00

For turning the engine over at
the crankshaft hex head screws.
With special relief-turned
section of accommodate
the small leakage return tubes.

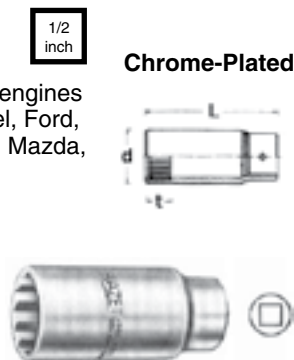

Chrome-Plated

SPAENAUR No.	HAZET No.	s mm	L mm	d mm	t mm
992-908	4555	27	82	36.2	15

Crown Wrench

Chrome-Vanadium
For tightening and slackening
the nozzle holder nuts
in Mercedes-Benz trucks
M 401/421, M 402/422, LA,A,
M 403/423, M 470 h,
MB-No. 403 589 04 07 00

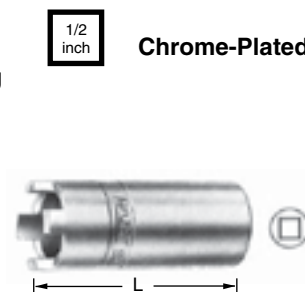

Chrome-Plated

SPAENAUR No.	HAZET No.	L mm
992-912	4558	72

For injection nozzles on
BMW-Diesel 524 td,
Ford-Diesel Lincoln
Continental (USA),
Lincoln Mark VII, VII LSC

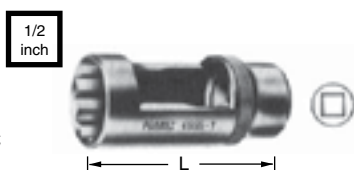

992-909	4555-1	20	82	36.2	15
---------	--------	----	----	------	----

N

Inch and Metric
Pouce et Métrique



Breaker Bar / Ratchet Head / 12 Point Sockets
Poignée articulée / Tête à rochet / Douilles à 12 pointes

Handle Bar

Chrome-Vanadium
with locking device

1
inch

Chrome-Plated

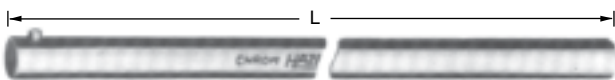

SPAENAUR No.	HAZET No.	L		Ø mm
		mm	inch	
991-871	1114	700	27-1/2	26

Sliding Part

To be fixed at Handle Bar
(= Sliding T-Handle)



Chrome-Plated

991-872	1115-1	80	3-1/8	48
---------	--------	----	-------	----

Reversible Ratchet Head

Chrome-Vanadium

1" ■,

■ with locking device,
shank with bolt for locking device,
32 teeth

Chrome-Plated

1
inch

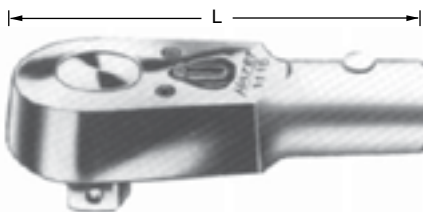

SPAENAUR No.	HAZET No.	L		Ø mm
		mm	inch	
991-874	1116	195	7-1/2	—

1" Sockets

12 Point Sockets

DIN 3124, ISO 2725

Chrome-Vanadium

1" □ drive,

with bolt for locking device

Chrome-Plated
Polished

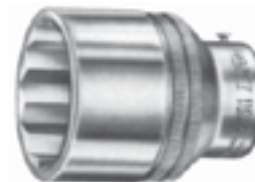

SPAENAUR No.	HAZET No.	mm	L mm	d ₁ mm	d ₂ mm	t mm
*991-860	1100 Z-32	32	65	48.0	46	23.4
*991-861	1100 Z-36	36	64	54.0	51	32.5
*991-862	1100 Z-41	41	69	60.0	51	35.5
991-863	1100 Z-46	46	73	66.0	54	34.5
991-864	1100 Z-50	50	77	71.0	54	38.0
991-865	1100 Z-55	55	82	77.5	57	41.0
991-866	1100 Z-60	60	87	83.5	57	43.5
991-867	1100 Z-65	65	91	90.0	57	45.0
991-868	1100 Z-70	70	95	96.0	60	49.0
991-869	1100 Z-75	75	100	102.5	60	52.5
991-870	1100 Z-80	80	109	108.5	60	59.5

* not according to DIN



For Hazet Wrenches see Page N3



Impact Adapters / Extensions / 6 Point Impact Sockets

Adaptateurs de clé à choc / Rallonges / Douilles de clé à chocs à 6 points



Inch and Metric
Pouce et Métrique

Impact Adapter

To hold impact sockets for use on electric and pneumatic drills, with 1/4" □ drive

1/4 inch

6,3
DIN 3121
(1/4")



E 6,3
DIN 3126,
Form E
(1/4")



SPAENAUR No.	HAZET No.	L		L mm
		mm	inch	
991-900	8508 S-3	6.3	1/4	50

Adapter

To hold impact sockets for application on electric and pneumatic drills, with 3/8" □ drive,

10
DIN 3121
(3/8")

5/16"



SPAENAUR No.	HAZET No.	L		L mm
		mm	inch	
991-930	8808 S-1	10	3/8	75

Impact Extensions

3/8" ■, 3/8" □ drive (DIN 3121)

3/8 inch



SPAENAUR No.	HAZET No.	L		inch
		mm	inch	
991-926	8805 S-6	152	6	3/8

1/2" Drive 6 Point Impact Sockets Long Pattern

1/2" □ drive
□ DIN 3121,
6 point DIN 475

1/2 inch



SPAENAUR No.	HAZET No.	mm	L mm	d ₁ mm	d ₂ mm	t mm
991-953	900 S Lg-13	13	85	20.8	25	8.5
991-954	900 S Lg-16	16	85	24.8	30	13.5
991-955	900 S Lg-17	17	85	26.2	30	13.5
991-956	900 S Lg-18	18	85	28.5	30	17.5
991-957	900 S Lg-19	19	85	28.8	30	17.5
▲ 991-958	900 S Lg-21	21	85	31.3	30	15.5
991-959	900 S Lg-22	22	85	32.5	30	17.5
991-960	900 S Lg-24	24	85	35.0	30	17.5
991-961	900 S Lg-27	27	85	38.8	30	19.5

▲ For wheel nuts/screws

Impact Adapters

3/4" □ drive

3/4 inch



992-022



992-023

SPAENAUR No.	HAZET No.	inch	inch	L mm
992-022	1007 S-1	1/2	3/4	56
992-023	1007 S-2	1	3/4	65