

Spanner Wrenches

Metric

Clés tricoises

Métrique

PIN-TYPE FACE SPANNER

For round nuts with drilled holes in face.

TOOL STEEL — Black Finish

With spot welded pins

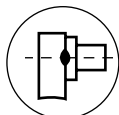
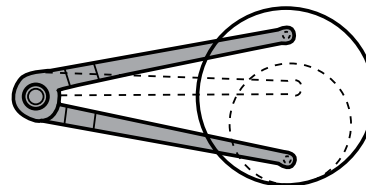

All dimensions in millimetres

SPAENAUR No.	Nom. Size	Pin Dia.	Pin Lgth.	O/A Length	Thickness
877-867	7-40	2.0	3.6	115	3.0
877-868	11-60	4.0	5.0	160	4.0
877-869	14-100	6.0	7.0	215	6.0
877-870	22-125	8.0	8.0	260	6.0
877-871	22-125	10.0	10.0	260	6.0

PKG QTY. 1

HINGED PIN-TYPE FACE SPANNER

For round nuts with drilled holes in face.

TOOL STEEL — Black Finish

With spot welded pins

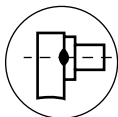

All dimensions in millimetres

SPAENAUR No.	Nom. Size	Pin Dia.	Pin Lgth.	O/A Length	Thickness
877-872	18-40	3.0	4.0	150	5.0
877-873	40-80	4.0	5.0	220	6.0
877-874	80-125	6.0	7.0	295	8.0
877-1483	125-200	8.0	8.0	405	10.0

PKG QTY. 1

The Hinge and Adjustable Pin-type Face Spanners on this page are not hardened but tempered, so there can be no brittle fractures caused by overstress.

P

Metric

Spanner Wrenches / Replacement Parts for Wrenches

Métrique

Clés tricoises / Pièces de rechange pour clés

HINGE-TYPE PIN SPANNER

For round nuts with pin holes according to DIN 1816

TOOL STEEL — Black Finish

All dimensions in millimetres



PKG QTY. 1

SPAENAUR No.	Nom. Size	Pin Dia.	Overall Length
877-258	20-35	2.5	135
877-253	20-35	3.0	135
877-254	35-60	4.0	175
877-259	60-90	5.0	250
877-256	90-155	8.0	290

HINGE-TYPE PIN SPANNER Replaceable Pins and Head Assemblies

For round nuts with pin holes according to DIN 1816

(To be discontinued as present stock is sold.)

All dimensions in millimetres

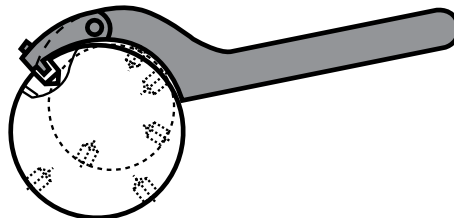
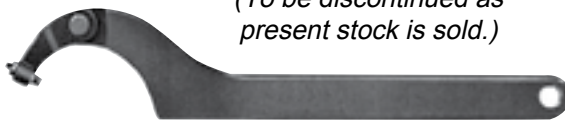

PKG QTY. 1



REPLACEMENT PIN with nut

SPAENAUR No.	Nom. Size	Pin Dia. ØD	L	M
877-857	20-35	3.0	3.0	2.0
877-858	20-35	4.0	4.0	2.0
877-859	35-60	4.0	4.0	3.5
877-860	35-60	5.0	5.0	3.5
877-861	60-90	5.0	5.0	4.0
877-862	60-90	6.0	6.0	4.0
877-864	90-155	8.0	8.0	5.0

KNIPEX - 'Cobra' Patented
(Pipe grip and spanner in one)



876-1203

- with box joint
- a new generation of Water pump Pliers, for easier and more secure work
- press button action for fast and firm adjustment directly on the work
- selected jaw opening is positively ensured
- 11-position adjustment
- 400 mm 'Cobra' with 15-position adjustment
- one hand adjustment
- the guard prevents operators' fingers being pinched
- gripping surfaces parallelogram-shaped with special hardened teeth
- hardness of jaws approx. 56 HRc
- self-gripping on pipes and nuts
- Material: Chrome Vanadium electric steel, oil-hardened

SPAENAUR No.	Mfg. No.	O/A Length		Head	Handles	Working Ø Cap. for pipes (dia.) inch	for nuts (across flats)		Wt. g
		mm	inch				mm	inch	
876-1202	8701180	180	7"	polished	plastic-coated	1/8" - 1-1/4"	6 - 30	1/4" - 1-3/16"	170
876-1657	8701250	250	10"			1/8" - 1-5/8"	6 - 36	1/4" - 1-7/16"	300
876-1203	8701300	300	12"			1/8" - 2"	7 - 48	9/32" - 1-7/8"	545
876-1204	8701400	400	15-1/2"			1/8" - 3"	10 - 65	3/8" - 2-9/16"	1000

PKG QTY. 1

CATALOG 14

SPAENAUR

Spanner Wrenches

Metric

Clés tricoises

Métrique

HOOK SPANNER

DIN 1810 A

For slotted round nuts to DIN 1804

TOOL STEEL — Black Finish

All dimensions in millimetres

SPAENAU No.	Nom. Size	Overall Length	Thickness
877-876	12-14	110	3.0
877-C07-1A	16-20	110	3.0
877-878	25-28	136	4.0
877-879	30-32	136	4.0
877-880	34-36	170	5.0
877-881	40-42	170	5.0
877-882	45-50	206	6.0
877-883	52-55	206	6.0
877-884	58-62	242	7.0
877-885	68-75	242	7.0
877-886	80-90	280	8.0
877-887	95-100	280	8.0
877-888	110-115	335	10.0
877-889	120-130	335	10.0
877-890	135-145	385	10.0
877-891	155-165	385	10.0
877-892	180-195	470	10.0
877-893	205-220	470	10.0
877-894	230-245	560	10.0
877-289	260-270	568	10.0
877-290	280-300	680	16.0



DIN 1810 B

PIN SPANNER

For round nuts with pin holes according to DIN 1816

TOOL STEEL — Black Finish

All dimensions in millimetres

SPAENAU No.	Nom. Size	Overall Length	Pin Dia.	Thickness
877-895	12-14	110	2.0	3.0
877-896	16-18	110	2.5	3.0
877-897	20-22	110	2.5	3.0
877-898	25-28	136	3.0	4.0
877-899	30-32	136	4.0	4.0
877-900	34-36	170	4.0	5.0
877-901	40-42	170	4.0	5.0
877-902	45-50	205	5.0	6.0
877-903	52-55	205	5.0	6.0
877-904	58-62	240	5.0	7.0
877-905	68-75	240	6.0	7.0
877-906	80-90	280	6.0	8.0
877-907	95-100	280	8.0	8.0
877-908	110-115	335	8.0	10.0
877-909	120-130	335	8.0	10.0
877-910	135-145	380	8.0	10.0
877-911	155-165	380	8.0	10.0
877-912	180-195	470	10.0	10.0
877-913	205-220	470	10.0	10.0

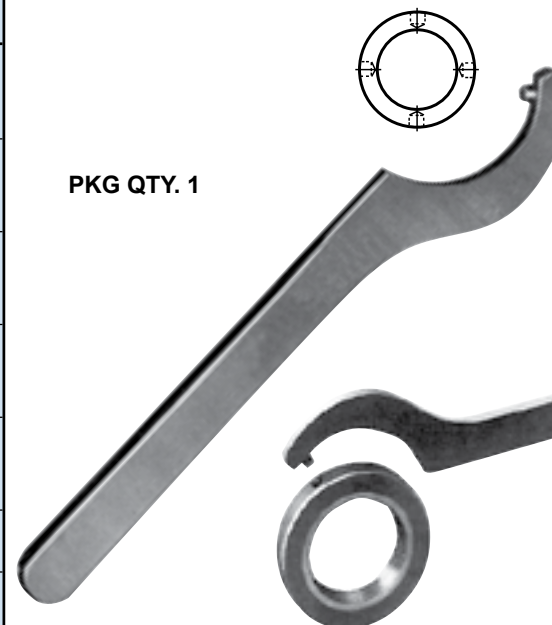

P

Metric

Arbor Wrench / Square Drive Wrench

Métrique

Clé d'arbre / Clé à prise carrée

DIN 6368

Metric Socket Wrench

SPANNER for shell and mill arbors
for cutter retaining screws DIN 6367

TOOL STEEL — Black Finish

SPAENAUR No.	*Nom. Size		Thread Dia.	Overall Length
877-836	13	13	M6	160
877-837	16	16	M8	180
877-839	22	22	M10	200
877-840	27	27	M12	225
877-841	32	32	M16	250
877-842	40	40	M20	280
877-844	60	60	M30	355

All dimensions in millimetres

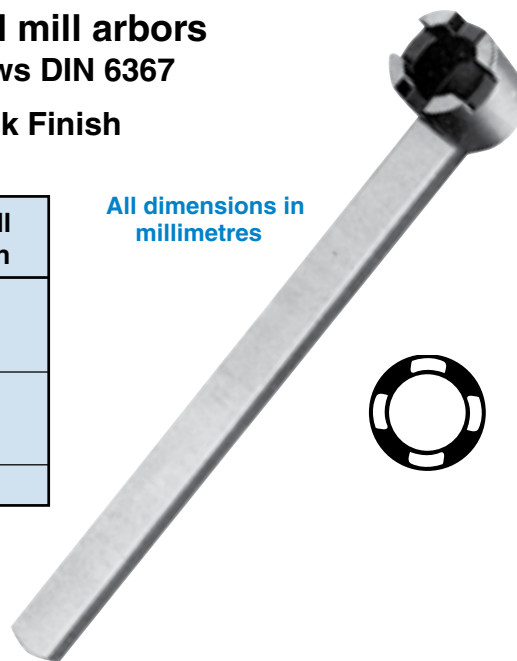



* Nominal size refers to the dia. of arbor.

Metric Square Drive Wrench with T-handle

Female

DIN 904L
Long Series

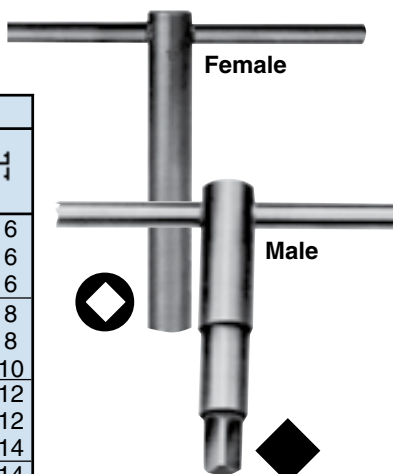

***DIN 904**
Short Series

FEMALE (For External Series)			
SPAENAUR No.	Nom. Size A/F		
▲877-460	5	120 x 12	160 x 6
▲877-461	6	160 x 12	160 x 6
*877-228	6	80 x 12	160 x 6
▲877-462	8	160 x 16	180 x 8
▲877-463	9	200 x 18	200 x 8
▲877-464	10	200 x 20	200 x 10
877-465	12	200 x 24	250 x 12
877-466	13	200 x 24	250 x 12
877-467	14	200 x 28	320 x 14
*877-229	14	120 x 28	320 x 14
877-468	17	250 x 34	400 x 16
877-469	19	320 x 36	400 x 16



Male

DIN 905

MALE (For Internal Series)			
SPAENAUR No.	Nom. Size A/F		
877-470	5	60 x 12	160 x 6
877-484	6	80 x 12	160 x 6
▲877-485	7	80 x 16	180 x 8
877-486	8	80 x 16	180 x 8
877-487	9	80 x 16	180 x 8
877-488	10	100 x 20	200 x 10
877-489	11	100 x 20	200 x 10
877-490	12	100 x 24	250 x 12
877-491	13	100 x 24	250 x 12
877-492	14	120 x 28	320 x 14
877-493	17	160 x 34	400 x 16
877-494	19	200 x 36	400 x 16
877-495	22	200 x 42	630 x 20

▲ TOOL STEEL
Black Finish

Not to DIN

All dimensions in millimetres

All items on this page PKG QTY. 1

Metric

Open-End Wrenches / Wrench Sets

Métrique

Clés à fourche / Jeux de clés

Single Open-End Wrench

TOOL STEEL - Black Finish

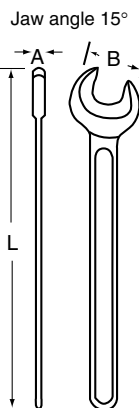

PKG QTY. 1

SPAENAUR No.	A/F	L mm	A mm	B mm
877-799	6	75	3.2	15.5
877-800	7	80	3.2	17.5
877-801	8	95	3.5	19.0
877-802	9	100	4.0	20.5
877-803	10	105	4.5	22.0
877-804	11	110	5.0	24.0
877-805	12	125	5.0	26.5
877-806	13	130	5.5	28.5
877-807	14	140	5.5	30.0
877-808	15	145	5.5	32.0
877-809	16	145	5.5	33.0
877-810	17	160	6.0	36.0
877-288	18	160	6.0	36.0
877-811	19	170	7.0	40.0
877-812	22	195	8.0	46.0
877-813	24	215	9.0	50.0
877-721	25	215	9.0	52.0
877-814	27	240	10.0	56.0
877-815	30	260	11.0	62.0
877-816	32	275	12.0	66.0
877-722	38	305	13.0	74.0
877-818	41	345	14.0	84.0
877-819	46	380	15.0	94.0
877-820	50	415	16.0	102.0
877-821	55	460	17.0	112.0
877-822	60	495	18.0	122.0
877-823	65	530	19.0	132.0
877-824	70	575	20.0	142.0
877-825	75	610	21.0	152.0
877-826	80	645	22.0	162.0
877-827	85	690	23.0	172.0
877-828	90	740	25.0	192.0
877-829	95	740	25.0	192.0
877-830	100	800	26.0	201.0
877-831	105	850	28.0	220.0
877-832	110	900	28.0	220.0
877-833	115	960	28.0	220.0
877-834	120	990	30.0	242.0

DIN 895

Double Open-End Wrench

TOOL STEEL - Black Finish

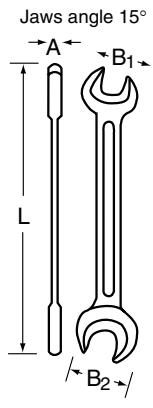

PKG QTY. 1

SPAENAUR No.	A/F	L mm	A mm	B1 mm	B2 mm
877-758	6 x 7	96	3.3	15.5	17.0
877-760	8 x 9	108	4.0	19.0	20.5
877-761	8 x 10	115	4.5	19.0	22.0
877-763	9 x 11	124	5.0	20.0	24.0
877-764	10 x 11	124	5.0	22.0	24.0
877-765	10 x 13	140	5.5	22.0	28.5
877-768	12 x 13	140	5.5	26.5	28.5
877-769	12 x 14	140	5.5	26.5	30.0
877-770	13 x 14	140	5.5	28.5	30.0
877-771	13 x 15	155	5.5	28.5	32.0
877-772	13 x 17	160	6.0	28.5	36.0
877-773	14 x 15	155	5.5	30.0	32.0
877-774	14 x 17	160	6.0	30.0	36.0
877-775	16 x 17	160	6.0	33.0	36.0
877-719	16 x 18	170	6.5	33.0	38.0
877-776	17 x 19	175	7.0	36.0	40.0
877-777	17 x 22	195	8.0	36.0	46.0
877-778	18 x 19	175	7.0	38.0	40.0
877-720	18 x 21	195	8.0	38.0	44.0
877-C12-1C	19 x 22	195	8.0	40.0	46.0
877-780	19 x 24	205	9.0	40.0	50.0
877-781	20 x 22	195	8.0	42.5	46.0
877-782	21 x 23	220	9.0	44.0	49.0
877-783	22 x 24	220	9.0	46.0	50.0
877-784	22 x 27	235	10.0	46.0	56.0
877-785	24 x 27	245	10.0	50.0	56.0
877-786	24 x 30	265	11.0	50.0	62.0
877-787	25 x 28	245	10.0	53.0	58.0
877-788	27 x 32	275	12.0	56.0	66.0
877-C13-1N	30 x 32	275	12.0	62.0	66.0
877-790	30 x 36	305	13.0	62.0	74.0
877-792	36 x 41	345	14.0	74.0	84.0
877-793	41 x 46	380	15.0	84.0	94.0
877-794	46 x 50	420	16.0	94.0	102.0
877-795	50 x 55	460	17.0	102.0	112.0
877-796	55 x 60	500	18.0	112.0	122.0
877-797	65 x 70	580	20.0	132.0	142.0
877-798	75 x 80	660	22.0	152.0	162.0

Double Open-End Wrench - EXTRA THIN

Purchase as a Set or Individually.

Contents of Set - 1 of each Wrench Listed Below



6-Piece Set
SPAENAUR Set No.
877-453
Steel Chrome Vanadium
Hardened and Nickel-Plated

Supplied in a plastic wallet.

SPAENAUR No.	A/F	Overall Length	Thickness
877-454	3 x 3.5	120	1.5
877-455	4 x 4.5	120	1.5
877-456	5 x 5.5	120	1.5
877-457	6 x 6.5	120	1.5
877-458	7 x 8	125	2.0
877-459	9 x 10	125	2.0

All dimensions in millimetres.