

Ullman® Inspection Tools

Inch

Outils d'inspection Ullman®

Pouce

INSPECTION MIRRORS for all angle viewing

Original All-Angle Ball Joint Mirrors with brushed finish stainless steel mirror backs.

Fast, accurate visual inspection of hidden areas with an almost limitless number of positions. Double ball joint links swivel mirrors for viewing to 360°. Ullman's precision engineered links are manufactured from tempered spring steel to withstand the stresses of constant repositioning, move freely and hold desired position.

FEATURES:

- Replaceable copper backed clear-view mirrors.
- Telescoping and pocket models.
- Non-rotating inner hex rods on telescopic models prevent mirrors from swinging out of alignment when in use.
- Insulating vinyl grip on all models.



876-1536 Rectangular Telescoping Mirror
2-1/8" x 3-1/2"
Overall length 11-1/4", extends to 15-1/4".

876-1543 Circular Telescoping Mirror

2-1/4" dia. Overall length 10", extends to 14".



876-1529 Circular Pocket Mirror
7/8" dia. Overall length 7-1/2".



876-1560 Replacement Head Assembly for 876-1529



876-1533 Oval Pocket Mirror
1" x 2". Overall length 8-1/2".



REPLACEMENT MIRRORS

SPAENAU No.	Mirror Size
876-1534	Oval 1" x 2"
876-1537	Rect. 2-1/8" x 3-1/2"

876-1667 INSPECTION MIRROR WITH EXTRA LONG HANDLE

Rectangular Telescoping Mirror, extra long handle
2-1/8" x 3-1/2". Overall length 17-1/4" extends to 27-1/4".



MAGNIFYING INSPECTION MIRROR

876-1668 Rectangular Magnifying Telescoping Mirror
2-1/8" x 3-1/2". Overall length 11-1/4", extends to 15-1/4".



MAGNIFYING MIRROR REPLACEMENT
SPAENAU No. **876-1669** Mirror Size Rect. 2-1/8" x 3-1/2"

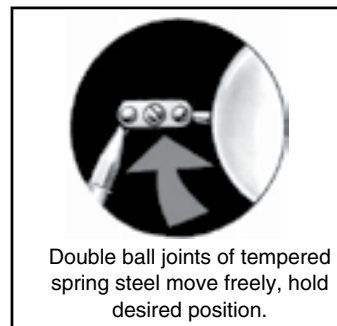

Double ball joints of tempered spring steel move freely, hold desired position.

P

Inch

Pouce

Ullman® Inspection Tools

Outils d'inspection Ullman®

Magnet Pick-up Tools

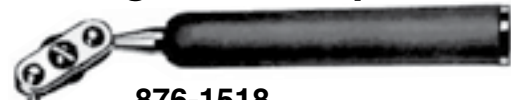

876-1518

Telescopic. Extends from 16-3/4", to 26-3/4". Folds down to 13"

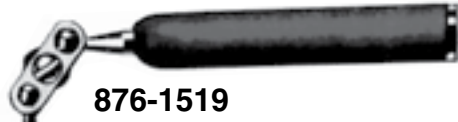

876-1519

Telescopic. Extends from 10-5/8", to 14-5/8". Folds down to 7-1/2"



876-1520

With a pocket clip. Overall length 8-1/2", folds to compact 6" for pocket storage.



**876-1514
Telescopic
Magnetic
Pocket
Pick-Up Tool**

Extends from 7" to 19-1/2", yet closes down to 4-1/2" pocket size.

876-1523

Mechanic's Insulated Pocket Magnet

Made of insulating polypropylene, unaffected by oil or gasoline, virtually unbreakable. Powerful chromium plated permanent magnet. Pencil shaped, 6" long. Supplied with a pocket clip.



The original all-angle retrieving tool with Alnico V magnets and molded nylon heads.

It picks up elusive ferrous metal bolts, nuts, washers, etc. in hard-to-reach places, even metal hand tools dropped while working on engines, boats or any place where pipes, panels or parts get in the way. Perfect for use under water, oil, etc.

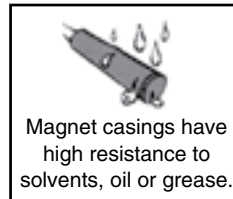

Magnet casings have high resistance to solvents, oil or grease.

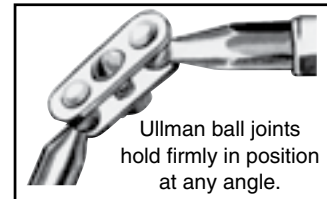

Ullman ball joints hold firmly in position at any angle.

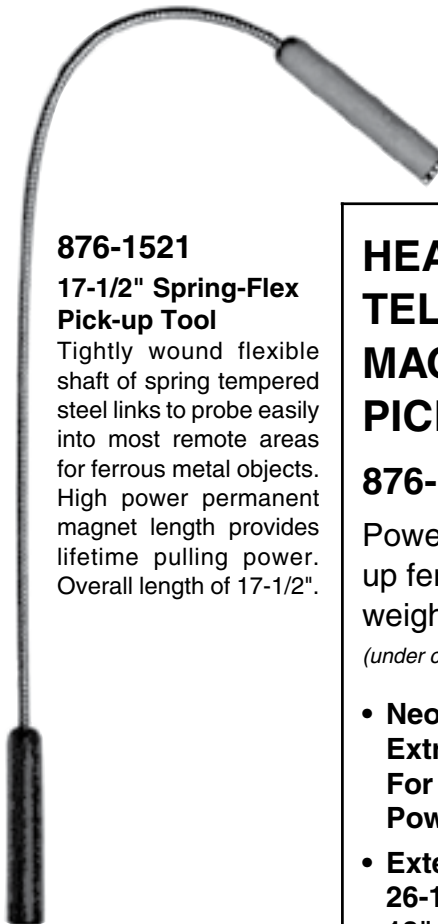

**876-1521
17-1/2" Spring-Flex
Pick-up Tool**

Tightly wound flexible shaft of spring tempered steel links to probe easily into most remote areas for ferrous metal objects. High power permanent magnet length provides lifetime pulling power. Overall length of 17-1/2".

**HEAVY DUTY
TELESCOPIC
MAGNETIC
PICK-UP TOOL**

876-1664

Powerful enough to pick up ferrous metal objects weighing 5 lbs.

(under correct conditions)

- **Neodymium-Iron-Boron Extra High Flux Magnet For Greater Pick-up Power.**
- **Extends from 16-1/4" to 26-1/2" - Folds Down to 13".**
- **Insulating Vinyl Grip.**

The Neodymium-Iron-Boron Magnet is powerful and it outperforms the standard Alnico V Magnet 4 to 1.

With the adjustable telescoping handle you can pick up heavy ferrous objects where your hands can not reach.



P

CATALOG 14

SPAENAUR

All items on this page
PKG QTY. 1

Ullman® Inspection Tools

Inch

Outils d'inspection Ullman®

Pouce

4-PIECE HOOK AND PICK SET

with aluminum handle and magnetic end.

876-1663

For separating wires, removing small fuses, "O" rings, retrieving washers and loose parts too small to pick up with your fingers. Bright-dipped, anodized, hex-shaped aluminum handle with powerful magnet on end. Handy screw-in hooks, picks, points and scribe. High carbon polished needle steel. All in a compact zipper pocket pouch that fits your shirt pocket.

Set includes these four screw-in tips plus handle.

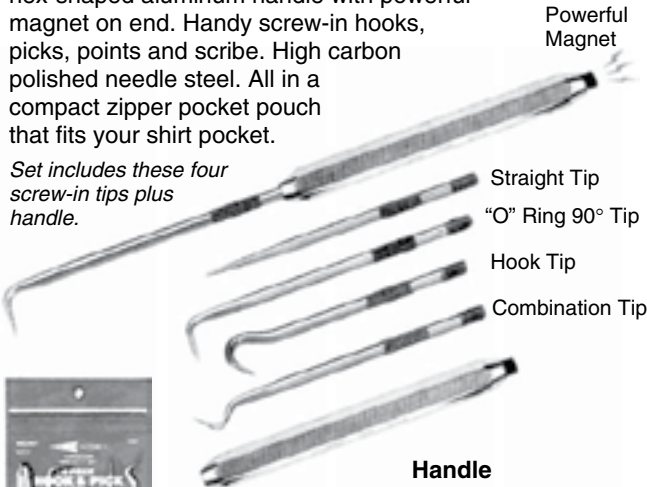

Powerful Magnet

Straight Tip

"O" Ring 90° Tip

Hook Tip

Combination Tip

Handle

Hex-shaped aluminum handle with magnet. Flats permit tight grip at any angle. Magnet picks up nuts, bolts, screws and other ferrous parts.



Zipper Pocket Pouch

Keeps tools organized and prevents torn clothing.

5-PIECE MICRO PICK SET

876-1665

These picks are ideal for soldering, gluing, positioning, adjusting and retrieving small parts. Separates chips, scrapes and scribes molds in motor armatures, dies, etc. The needle tips are made of a high quality stainless steel and the set comes packaged in a zippered top vinyl pouch.

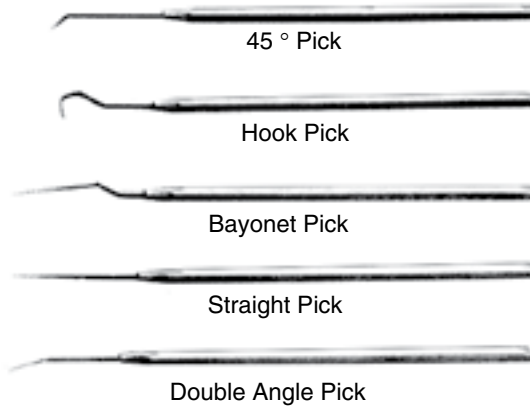

45 ° Pick

Hook Pick

Bayonet Pick

Straight Pick

Double Angle Pick

SWINGER

Combination reversible pick and hook. Like an extra strong fingernail for jobs in awkward places. Just swivel out the end you want, the other tucks safely away. Literally a tool of "1001 uses!" Lightweight aluminum handle. Overall length 7-7/8".

876-1538



876-1666

4-PIECE INDIVIDUAL HOOK AND PICK SET

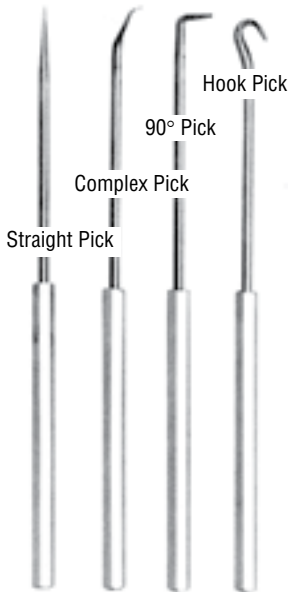

Hook Pick

90° Pick

Complex Pick

Straight Pick

Ideal for separating wires, removing small fuses, "O" rings, retrieving washers and loose parts too small to pick up with your fingers. Each hook and pick is made of high carbon polished steel and is permanently attached to a hex shaped aluminum handle.

APPLICATIONS...



...release or install headlight springs.



...remove small fuses, stuck parts.



...separate small wires in awkward places.



...retrieve lost nuts, bolts, washers, tools from tight areas.



...remove springs from oil burner relay boxes.

Inch

Pouce

Ullman® Inspection Tools

Outils d'inspection Ullman®

UTILITY PACKING HOOK
with magnetic pick-up in handle.

Used for removing springs, wadding, washers, "O" rings - prying stuck gaskets loose.

876-1670

Handy steel hook for any tool box; repairmen, technicians, service personnel. 7" long, has strong steel shaft and hook, knurled aluminum handle. Magnetic end retrieves dropped nuts, bolts, washers, parts.



DOUBLE POINTED SCRIBER
with straight and 90° angle points for marking in awkward places.

876-1515

Overall length 9-3/8".

Heat treated, bright polished, high carbon needle steel points. For the technician or craftsman who needs a sharp marking tool that works in cramped quarters, as well as, in regular applications. Knurled aluminum handle gives sure grip.



POCKET SCRIBER

All-in-one "Push-Click" SAFETY COVER on Tungsten Carbide with Magnetic Pick-Up.



Overall length 5-1/2".

876-1542

Sharp tungsten carbide tip cuts into hard surfaces, leaves clear mark on metal, glass, plastics, tools. Powerful magnet on end retrieves dropped metal items. Knurled handle, handy pocket clip.

To expose tip - Just pull cover down and twist. It locks in position.



To protect tip - Just turn cover clockwise. It automatically "clicks" shut!

MAGNETIZER / DEMAGNETIZER

Magnetizes and demagnetizes screwdrivers and other small tools.

Works in seconds – simple to use.

Speeds up repair and assembly jobs. Picks up screws, nuts, metallic parts, cleans up filings, scraps and starts screws.



876-1544

Overall size 1-1/16" x 1-1/16" x 1-1/16".

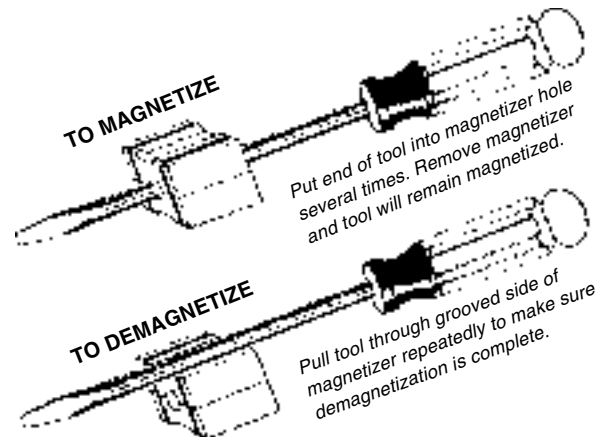

TO MAGNETIZE

Put end of tool into magnetizer hole several times. Remove magnetizer and tool will remain magnetized.

TO DEMAGNETIZE

Pull tool through grooved side of magnetizer repeatedly to make sure demagnetization is complete.

CATALOG 14

SPAENAUR

All items on this page
PKG QTY. 1

Ullman® Screw & Nut Starters

Inch and **Metric**

Pose-vis et pose-écrous Ullman^{MD}

Pouce et **Métrique**

MECHANICAL SCREW STARTERS for ferrous or non-ferrous screws

Standard Slotted Screw Starters



MAGNETIC ENDS



No more fumbling with hard-to-position screws! A simple twist of the Ullman alloy steel bit and screw is firmly held, ready for trouble-free starting. Tool, releases and resets automatically. Slender aluminum handles for easy access into close areas.

Should a screw, washer or nut be dropped into a hard-to-reach area, it can easily be retrieved by turning the tool around and using the strong full 1" permanent magnet on the opposite end of the aluminum handle screw starter.

SPAENAUR No.

Size

876-1530 Overall length 2-5/8".

876-1531 - with pocket clip. Overall length 5-5/8".

876-1532 Overall length 9-5/8".

PKG QTY. 1

876-1513 DOUBLE-ENDED SCREW STARTER with Nylon shaft.

Overall length 9" with Phillips and Slotted heads.



Slotted Drive

PKG QTY. 1

Phillips Drive

TORX® / PHILLIPS / HEX SOCKET SCREW STARTER

For headlight bezel, turnlight assemblies, mirror mounts, exterior trim, carburetor and ignition systems.

876-1517

Fits TORX® screw sizes T-10 to T-30.



Also fits most Hex Socket and Phillips screws.

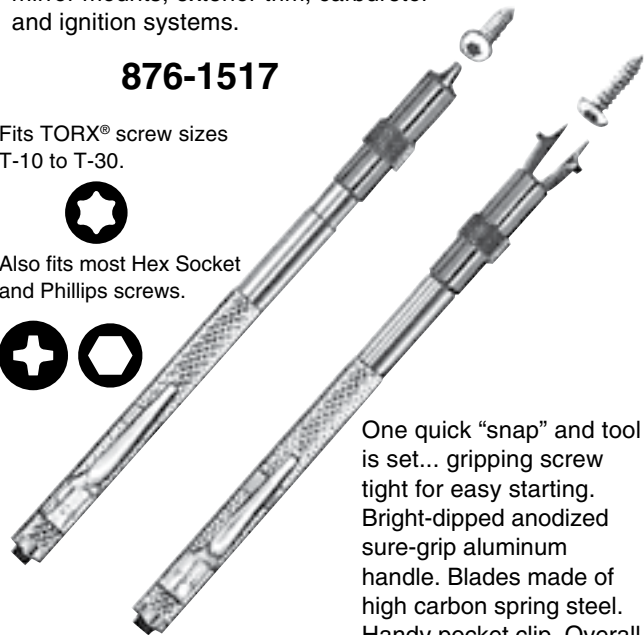

One quick "snap" and tool is set... gripping screw tight for easy starting. Bright-dipped anodized sure-grip aluminum handle. Blades made of high carbon spring steel. Handy pocket clip. Overall length 5-5/8". Permanent magnet at opposite end retrieves nuts or screws dropped in hard-to-reach areas.

PKG QTY. 1

NUT STARTER

876-F03-1Y

Use on all small size nuts to start nuts on bolt thread. Releases from nut as threads are engaged.

PKG QTY. 1



Fits Sizes:

4-40 Thread 3/32" 2.5 mm to 5/16" 8 mm

- Snap in Nut
- Start Threads
- Self Releasing

Overall length 5-1/8".

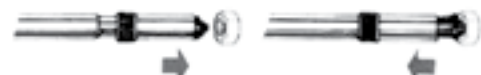

1. Push head up. Insert blades into nut.
2. Snap head down. Blades grip nut tightly.

Inch

Ullman® Tool Organizers / Magnetic Pick-Up Tools

Pouce

Rangements pour outils / Ramasse-pièces magnétiques Ullman®

MAGNETIC SAFETY FEEDER TOOL



876-1522

Feeds and retrieves hard-to-handle ferrous metal parts. Reduces press accidents, fatigue. Permanent magnet lifts up to 10 lbs. Chrome finished. Easy-grip fluted handle. Overall length 14".

PKG QTY. 1

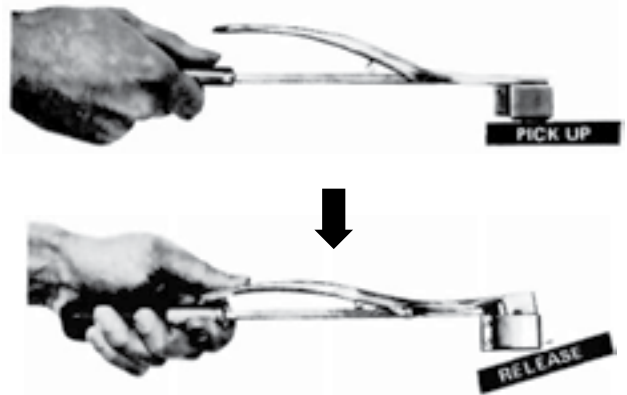

SOCKET HOLDERS WITH HEAVY-DUTY SPRING CLIPS

Bright, durable, plated steel rail with slide-on spring clips to hold sockets tight and rattle proof, yet easily removable. Screw into tool chest drawer or hang.

SPAENAUR No.	Size
876-1524	17" rack with sixteen 1/4" drive clips.
876-1525	17" rack with sixteen 3/8" drive clips.
876-1526	17" rack with sixteen 1/2" drive clips.
876-1528	17" rack with eight 3/4" drive clips.

PKG QTY. 1

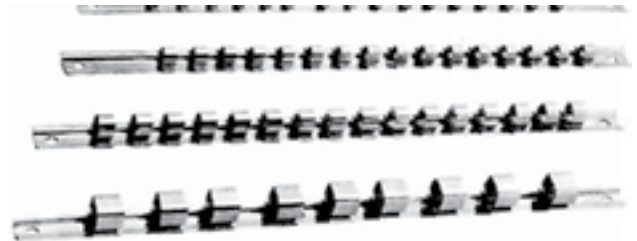

HEAVY-DUTY REPLACEMENT CLIPS

SPAENAUR No.	Size	All clips fit all Socket Holders and are sold in
876-1660	1/4" drive clips.	PKG QTY. 10
876-1661	3/8" drive clips.	
876-1527	1/2" drive clips.	
876-1662	3/4" drive clips.	

PENCIL-TYPE MAGNET WITH CLIP

Ideal for instant pickup and for testing metals. Keep it handy in your pocket with pens and pencils.

SPAENAUR No. 876-488

PKG QTY. 1



SPAENAUR No. 876-490

Powerful little magnets on a key chain - always handy. Pick up small parts, retrieve parts which have fallen out of reach, test metals.....

CATALOG 14

SPAENAUR