

**Taper Pins**

Inch

**Goupilles coniques**

Pouce

**MILLED STEEL  
TAPER PINS**

**Low Carbon Steel**

**Not Plated**

**ASME B18.8.2**

Milled from solid bar STEEL.



DIAMETER IS MEASURED AT THE LARGE END

**STANDARD TAPER**  
1/4" PER FOOT or .0208" PER INCH

Tolerance on Diameter  
+0.0013" to -0.0007"

Length Tolerance ±0.030"

SIZE	7/0	6/0	4/0	000	00	0	1	2	3	4
Diameter Large End	.0625	.0780	.1090"	.125"	.141"	.156"	.172"	.193"	.219"	.250"
Approx. Fraction	1/16"	5/64"	7/64"	1/8"	9/64"	5/32"	11/64"	3/16"	7/32"	1/4"
5/8"			239-499							239-500
3/4"					239-501	239-462	239-465	239-468	239-472	239-476
7/8"							239-466			
1"					TP-601	TP-603	TP-605	239-469	239-473	
1-1/8"									239-474	
1-1/4"				239-502		239-463	239-494	TP-608	TP-611	239-477
1-1/2"	239-498	239-497			TP-602	TP-604	TP-606	TP-609	TP-612	TP-614
1-3/4"						239-D14-1K		239-470		239-478
2"			239-496		239-438	239-440	TP-607	TP-610	TP-613	TP-615
2-1/4"							239-467		239-475	239-479
2-1/2"			239-508	239-507	239-506	239-505	239-441	239-442	239-445	TP-616
2-3/4"								239-471		239-480
3"					239-439	239-433	239-434	239-443	239-446	239-448
3-1/2"								239-444	239-435	
4"									239-447	239-436

SIZE	5	6	7	8	9	10	11
Diameter Large End	.289"	.341"	.409"	.492"	.591"	.706"	.860"
Approx. Fraction	19/64"	11/32"	13/32"	1/2"	19/32"	23/32"	55/64"
1"		239-482					
1-1/4"	239-481	239-483	239-486				
1-1/2"	TP-617	TP-600	239-487				
1-3/4"	TP-618	239-D12-1N	239-488				
2"	TP-619	TP-621	TP-631				
2-1/4"		239-485	239-489				
2-1/2"	TP-620	TP-622	TP-624	239-962			
2-3/4"		239-493	239-490				
3"	TP-632	TP-623	TP-625	239-454			
3-1/2"	239-449		239-491			239-459	
3-3/4"			239-495				
4"	TP-626	239-451	239-453	239-455	239-457		
5"	239-450	TP-627	239-437	239-456	239-458	239-460	
6"	239-504	239-452	TP-628	TP-629	TP-630	239-461	239-503
7"						239-510	

Contact Sales Desk  
For Package Quantities

See page P30 for  
Taper Pin Reamers.

CATALOG 14

SPAENAUR

Inch

**Taper Pins / Grooved Pins / Taper Pins Assortment**

Pouce

Assortiment de goupilles coniques / goupilles cannelées / goupilles coniques

**316 Stainless Steel TAPER PINS**



Standard Taper Pins  
1/4" per foot or .0208" per inch

Tolerance on Diameter +0.0013" to -0.0007"  
Length Tolerance ±0.030"

SIZE	00	1	2	4	5	6	7	8	9	10
Diameter Large End	.141"	.172"	.193"	.250"	.289"	.341"	.409"	.492"	.591"	.706"
Approx. Fraction	9/64"	11/64"	3/16"	1/4"	19/64"	11/32"	13/32"	1/2"	19/32"	23/32"
Length										
1/2"	240-806					240-801				
1"		240-805								
1-1/2"					240-809					
2"			240-811							
3"				240-802	240-803	240-804	240-813			
3-3/4"									240-812	
4"				240-810	240-808					
6"								240-800		240-817

Contact Sales Desk For Package Quantities

**GROOVED PINS**

Case Hardened  
Low Carbon STEEL  
Zinc Chromate Plated  
ALL GROOVED PINS  
PKG QTY. 100

Styles	SPAENAUR No.	Size
<p><b>Type A (#1)</b> - Full-length taper. Does not require a reamed hole.</p>	<p><b>239-200</b> <b>239-201</b></p>	<p>1/4" x 3/4" 1/4" x 1"</p>
<p><b>Type E (#5)</b> - Centre groove. Ideal for rod assemblies, also as a hinge pin.</p>	<p><b>239-197</b> <b>GP-100</b></p>	<p>3/32" x 1/2" 3/16" x 3/4"</p>

Grooved Pins are a non-threaded press fit type fastener needing only a straight drilled hole without close tolerances or reaming. They are used as locking pins, pivots, locating devices, hinge pins or fulcrums. Recommended drill size is the same as the nominal diameter.

**ASSORTMENT A-218**

Made to ASME B18.8.2

**INCH SIZES TAPER PINS STEEL, Not Plated**



Regular Size welded STEEL drawer has hinged lid, SCOOPED bins, and is finished in Grey enamel. Drawer fits Slide Racks shown on page A2

**23 SIZES 186 PIECES**

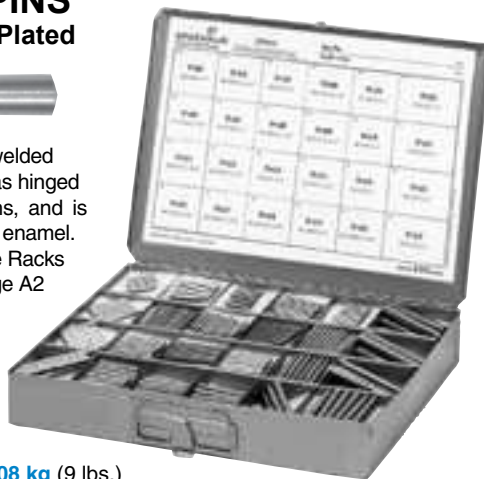

Shipping Weight: **4.08 kg** (9 lbs.)

Spaenaur No.	Pin Size Number	Large End Diameter	Pin Length	Qty.	Page
TP-601	#00	0.141"	1"	10	E88
TP-602			1-1/2"		
TP-603	#0	0.156"	1"		
TP-604			1-1/2"		
TP-605	#1	0.172"	1"		
TP-606			1-1/2"		
TP-607			2"		
TP-608	#2	0.193"	1-1/4"		
TP-609			1-1/2"		
TP-610			2"		
TP-611	#3	0.219"	1-1/4"		
TP-612			1-1/2"		
TP-613			2"		
TP-614	#4	0.250"	1-1/2"		
TP-615			2"		
TP-616			2-1/2"		
TP-617	#5	0.289"	1-1/2"		
TP-618			1-3/4"		
TP-619			2"		
TP-620	#6	0.341"	2-1/2"		
TP-621			2"		
TP-623			3"		
TP-625	#7	0.409"	3"	8	

Taper Pins / Assortment

Metric

Goupilles coniques / Assortiment de goupilles coniques

Métrique

# Metric TAPER PINS – Steel

**ISO 2339A**

**Ground Hardened Not Plated**

**PROPERTY CLASS 5.8 (72,500 PSI)**

**TAPER 1 : 50 (2%) Milled from solid bar STEEL**

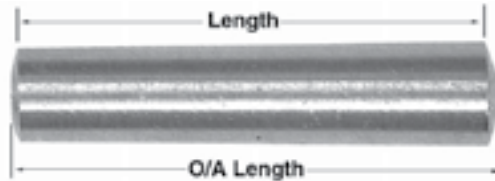

DIAMETER IS MEASURED AT THE SMALL END NOMINAL DIAMETER = SMALL END DIAMETER

Nom. Dia.	3 mm	4 mm	5 mm	8 mm	10 mm
Length (mm)	<b>ORDER BY SPAENAUR NUMBERS LISTED BELOW</b>				
12	<b>238-400</b>				
30			<b>238-420</b>	<b>238-436</b>	
35	<b>238-406</b>	<b>238-412</b>			
40		<b>238-413</b>	<b>238-422</b>		
50					<b>238-448</b>
60					<b>238-449</b>
80				<b>238-443</b>	
<b>PKG QTY. 25</b>					

E

**ASSORTMENT 805-474**

**DIN 1**

This Standard has been replaced. Please see Catalog Page R21 for more information.

## METRIC TAPER PINS

## 24 SIZES - 200 PIECES

**STEEL, Not Plated Turned Not Hardened**



Regular size welded STEEL drawer has hinged lid, "scooped" bins, and is finished in Grey enamel. Drawer fits Slide Racks shown on page A2

Shipping weight: **3.74 kg (8.25 lbs.)**

Small End Diameter	Spaenaur No.	Pin Length	Qty.	Page		
3mm	<b>238-302</b>	20mm	10	E91		
	<b>238-304</b>	26mm				
	<b>238-306</b>	30mm				
	<b>238-309</b>	40mm				
4mm	<b>238-314</b>	20mm				
	<b>238-316</b>	26mm				
	<b>238-318</b>	30mm				
	<b>238-321</b>	40mm				
5mm	<b>238-325</b>	20mm			6	E92
	<b>238-329</b>	30mm				
	<b>238-332</b>	40mm				
	<b>238-334</b>	50mm				
6mm	<b>238-337</b>	20mm				
	<b>238-340</b>	30mm				
	<b>238-342</b>	40mm				
	<b>238-344</b>	50mm				
8mm	<b>238-351</b>	30mm				
	<b>238-352</b>	36mm				
	<b>238-353</b>	40mm				
	<b>238-354</b>	50mm				
10mm	<b>238-362</b>	32mm				
	<b>238-363</b>	40mm				
	<b>238-364</b>	50mm				
	<b>238-365</b>	60mm				

Metric

Taper Pins

Métrique

Goupilles coniques

# Metric TAPER PINS

## FREE-CUTTING STEEL

TAPER 1 : 50  
(2%)

**DIN 1**

This Standard has been replaced. Please see Catalog Page R21 for more information.

**Turned Not Hardened Not Plated**

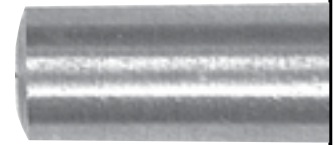

DIAMETER IS MEASURED AT THE SMALL END NOMINAL DIAMETER = SMALL END DIAMETER

Nom. Dia.	1 mm	1.5 mm	2 mm	2.5 mm	3 mm	4 mm	5 mm
<b>Length (mm)</b>	<b>ORDER BY SPAENAUR NUMBERS LISTED BELOW</b>						
8							
10		238-378	238-389	238-465		238-934	238-1328
12		238-379	238-390	238-466			
14	238-376		238-391	238-467	238-300	238-935	
16		238-381	238-392	238-468	238-301	238-312	238-938
18		238-382	238-393	238-469		238-313	
20		238-383	238-394	238-470	238-302	238-314	238-325
22						238-936	238-939
24		238-384		238-471		238-315	238-326
25			*238-1326				
26		238-385	238-396	238-472	238-304	238-316	238-327
28		238-386	238-397	238-473		238-317	238-328
30		238-387	238-398	238-474	238-306	238-318	238-329
32			238-461	238-475		238-319	238-330
36			238-462	238-476		238-320	238-331
40				238-477	238-309	238-321	238-332
45				238-478	238-482	238-322	238-333
50			238-464	238-479	238-310	238-323	238-334
55						238-937	
60					238-311	238-324	238-335
70					238-483	238-485	238-336
80						238-486	238-489
90						238-487	238-490
100							238-491
	PKG QTY. 50				PKG QTY. 25		

\*PKG QTY 25

Continued on next page...

For inch size TAPER PINS, see page E89.  
See our line of Metric Taper Pin Reamers on Pages P45

Taper Pins

Goupilles coniques

Metric

Métrique

TAPER 1 : 50  
(2%)

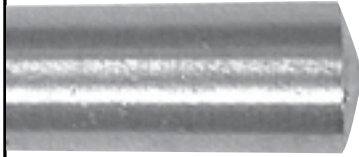

# Metric TAPER PINS

## FREE-CUTTING STEEL

**DIN 1**

This Standard has been replaced.  
Please see Catalog Page R21 for  
more information.

**Turned Not Hardened Not Plated**

DIAMETER IS MEASURED AT THE SMALL END NOMINAL DIAMETER = SMALL END DIAMETER

Nom. Dia.	6 mm	8 mm	10 mm	12 mm	13 mm	16 mm	20 mm
<b>Length (mm)</b>	<b>ORDER BY SPAENAUR NUMBERS LISTED BELOW</b>						
	<i>...Continued from previous page</i>						
16	<b>238-940</b>						
20	<b>238-337</b>	<b>238-949</b>					
24	<b>238-338</b>						
25					<b>238-375</b>		
26	<b>238-339</b>	<b>238-495</b>					
28	<b>238-492</b>	<b>238-350</b>					
30	<b>238-340</b>	<b>238-351</b>	<b>238-C15-1C</b>				
32	<b>238-493</b>	<b>238-951</b>	<b>238-362</b>				
36	<b>238-341</b>	<b>238-352</b>	<b>238-498</b>	<b>238-C42-1N</b>	<b>238-955</b>		
40	<b>238-342</b>	<b>238-353</b>	<b>238-363</b>	<b>238-757</b>	<b>238-768</b>	<b>238-778</b>	
45	<b>238-343</b>	<b>238-496</b>	<b>238-499</b>	<b>238-758</b>			
50	<b>238-344</b>	<b>238-354</b>	<b>238-364</b>	<b>238-373</b>			<b>238-789</b>
60	<b>238-345</b>	<b>238-355</b>	<b>238-365</b>	<b>238-759</b>	<b>238-C38-1Y</b>	<b>238-780</b>	<b>238-790</b>
70	<b>238-346</b>	<b>238-356</b>	<b>238-366</b>	<b>238-D16-1X</b>		<b>238-781</b>	<b>238-791</b>
80	<b>238-347</b>	<b>238-357</b>	<b>238-367</b>	<b>238-761</b>	<b>238-772</b>	<b>238-782</b>	
90	<b>238-348</b>	<b>238-358</b>	<b>238-368</b>	<b>238-762</b>		<b>238-783</b>	
100	<b>*238-349</b>	<b>238-359</b>	<b>238-369</b>	<b>238-763</b>	<b>238-774</b>	<b>238-784</b>	
110		<b>238-360</b>	<b>238-370</b>	<b>238-764</b>	<b>238-775</b>		
120	<b>238-494</b>	<b>238-361</b>	<b>238-371</b>	<b>238-765</b>	<b>238-776</b>	<b>238-372</b>	<b>238-796</b>
140			<b>238-755</b>	<b>238-766</b>	<b>238-777</b>	<b>238-786</b>	<b>238-797</b>
150			<b>238-952</b>				
	<b>PKG QTY. 25</b>				<b>PKG QTY. 10</b>	<b>PKG QTY. 5</b>	
	<b>*238-929 A2 Stainless Steel</b>						

For our full line of Taper Pins see pages E88-E95

See our Metric Taper Pin Reamers on page P45

E

CATALOG 14

SPAENAUR

Metric

Taper Pins

Métrique

Goupilles coniques

**Metric TAPER PINS**  
with External Parallel Thread\*  
**STEEL Not Hardened, Not Plated**

\*Metric Regular (Coarse) Thread

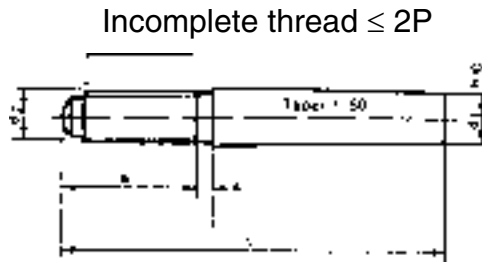

**DIN 7977**

This Standard has been replaced. Please see Catalog Page R21 for more information.

Ground to h10 tol. on pin dia.

d1 Dia.	5mm	6mm	8mm	10mm	12mm	14mm	16mm	20mm	
d2	M5	M6	M8	M10	M12	M12	M16	M16	
b	14mm	18mm	22mm	24mm	27mm	30mm	35mm	35mm	
A	2.4mm	3mm	4mm	4.5mm	5.3mm	6mm	6mm	6mm	
Length (L)		ORDER BY SPAENAUR NUMBERS LISTED BELOW							
mm	~inch								
40	1-9/16"	238-1031	238-1036	238-1044					
45	1-3/4"	238-1032	238-1037	238-C26-1Y					
50	2"	238-1033	238-1038	238-1046	238-1054				
55	2-3/16"		238-1039	238-C50-1A					
60	2-3/8"	238-C46-1M	238-1040	238-1048	238-1055				
65	2-9/16"		238-1041	238-1049	238-1056				
75	3"		238-1042	238-1050	238-1057	238-1061		238-1070	
85	3-3/8"		238-1043	238-1051	238-1058	238-1062	238-1066	238-1071	
100	4"			238-1052	238-1059	238-1063	238-1067	238-1072	238-1076
120	4-3/4"			238-1053	238-1060	238-1064	238-1068	238-1073	238-1077
140	5-1/2"					238-1065		238-1074	238-1078
160	6-1/4"							238-1075	
PKG QTY. 25						PKG QTY. 10		PKG QTY. 5	

See pages E90-E92 for Metric Taper Pins

**Metric**

Half length Taper Grooved Pins



**DIN 1472**

This Standard has been replaced. Please see Catalog Page R21 for more information.

PKG QTY. 100  
(EXCEPT 8 mm -  
PKG QTY. 50)

Plain Steel

238-1315	3 mm x 20 mm
238-1316	4 mm x 25 mm
238-1312	5 mm x 35 mm
238-1336	8 mm x 50 mm

**Metric**

Full length Grooved Pins

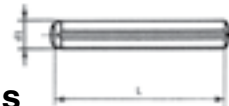

**DIN 1473**

This Standard has been replaced. Please see Catalog Page R21 for more information.

Plain Steel

PKG QTY. 50

238-1311	8 mm x 50 mm
----------	--------------

Taper Pins / Yoke Pins / Yoke Fork Heads

Metric

Goupilles coniques / Axes pour embout à chape / Embouts à chape

Métrique

**Metric TAPER PINS**  
with Internal Parallel Thread\*

**DIN 7978A**

This Standard has been replaced. Please see Catalog Page R21 for more information.

Free Cutting STEEL,  
Not Hardened, Not Plated

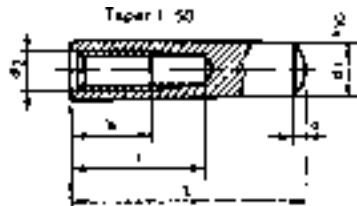

Ground to h10 tol.  
on pin dia.

Metric Regular (Coarse) Thread

d1 Dia.	6mm	8mm	10mm	12mm	16mm	20mm
~a	0.8mm	1mm	1.2mm	1.6mm	2mm	2.5mm
d2	M4	M5	M6	M8	M10	M12
b	6mm	8mm	10mm	12mm	16mm	18mm
t min.	10mm	12mm	16mm	20mm	25mm	28mm

E

Length (L)	ORDER BY SPAENAUR NUMBERS LISTED BELOW					
16 mm	238-1080					
20	238-1081	238-1095				
24	238-1082	238-1096				
26		238-1097				
28	238-1084	238-1098	238-1110			
30	238-1085	238-1099	238-1111			
32	238-1086	238-1100	238-1112			
36	238-1087	238-1101	238-1113	238-1123		
40	238-1088	238-1102	238-1114	238-1124	238-1133	
45	238-1089	238-D08-1C	238-1115	238-1125		
50	238-1090	238-1104	238-1116	238-1126	238-1134	238-1142
55	238-1091	238-1105	238-1117		238-1135	
60	238-1092	238-1106	238-1118	238-1127	238-1136	238-1143
70	238-1093	238-1107		238-1128	238-C27-1C	238-1144
80	238-1094	238-1108	238-1120	238-1129	238-1138	238-1145
90			238-1121	238-1130		
100		238-1109	238-1122	238-1131	238-1139	238-1146
120				238-1132	238-1140	238-1147
140						238-1148
	PKG QTY. 25			PKG QTY. 5		

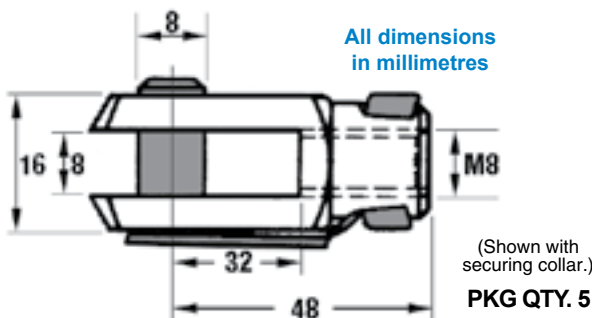

**SPAENAUR No. 699-009ZP**  
**Metric Fork Heads (Yokes)**

**DIN 71752** – Steel – Zinc Plated

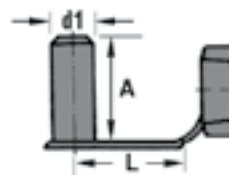

PKG QTY. 10

**ES Bolts with securing collar**  
**Steel – Zinc Plated**  
**For use with DIN 71752**

SPAENAUR No.	Dimensions (d1 x A x L)
086-013ZP	8 mm x 19 mm x 32 mm
086-014ZP	10 mm x 23 mm x 20 mm

CATALOG 14

SPAENAUR