

Snap Hooks

Inch and Metric

Crochets à pression

Pouce et Métrique

SPRING SNAPS



Cast Malleable Iron
Loop Eye
Nickel Plated
▲ Die Cast

SPAENAUR No.	Size of Eye	Length Overall	Ring Size Snap Opening	PKG QTY.
▲MH-54	1/2"	1-5/8"	.177"	25
MH-55	5/8"	1-5/8"	.177"	25
MH-56	3/4"	1-5/8"	.177"	25
MH-57A	7/8"	1-3/4"	.177"	25
MH-59	2"	1-3/4"	.177"	25



Loop Eye
Sheet Steel
Nickel Plated

MH-60	1/2"	1-3/4"	.177"	25
MH-62	3/4"	1-3/4"	.177"	25



Cast Malleable Iron
Swivel Eye
Nickel Plated

121-C42-1Y	3/8"	1-15/16"	.156"	25
------------	------	----------	-------	----



SPAENAUR No. 122-439
Snap Hook
(Flag Snap)

Colour:
Natural

This snap can be used with any cord up to 3/8" dia. It has all the characteristics of metal snaps, as well as other advantages only found using thermoplastic material. The material is versatile because it will not scratch surfaces, freeze or rust after many years of service.

O/A Lgth.
Approx.
2-3/8"

PKG QTY. 25

Other colours available

Key Ring BELT SNAP Assemblies

Metal Die Cast SNAP

Nickel Plated

SPAENAUR No. 121-146



Steel Ring
Nickel Plated

Spaenaur No. 121-146	
Snap Opening	15/64" 6 mm
Snap O/A Length	2-3/8" 60 mm
Ring I.D.	13/16" 20.64 mm
O/A Assembly Length	3-1/8" 80 mm

PKG QTY. 10

BOLT SNAPS

Metal Die Cast Nickel Plated
Double Pattern

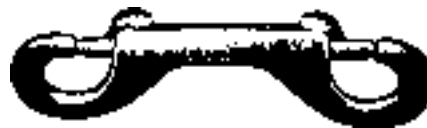

SPAENAUR No.	Length Overall	Ring Size Snap Opening	PKG QTY.
121-173	3-1/2"	3/8"	25
121-174	4-1/8"	7/16"	25

Cast Malleable Iron Zinc or Cadmium Plated at our option.

Open Eye, Light Chain Patterns



SPAENAUR No.	Size of Eye	Length Overall	Ring Size Snap Opening	PKG QTY.
121-171	3/8"	3-1/4"	5/16"	25
121-172	3/8"	3-1/2"	3/8"	25

Zinc Die-Cast Nickel Plated
Swivel Round Eye



121-228	1/2"	2-15/16"	11/32"	10
123356N	1/2"	2-15/16"	11/32"	10
121-229	5/8"	3-1/8"	3/8"	10
121-191	3/4"	3-1/4"	5/16"	25
*MH-157	3/4"	4-1/16"	3/8"	25
121-230	7/8"	3-5/16"	3/8"	10
121-231	1"	3-1/2"	3/8"	10

* Furnished in Cast Mall. Iron - Cad. Plated

CAST SOLID BRASS



Plain Finish

MH-70	3/8"	3"	1/4"	25
-------	------	----	------	----

See page M50-M53 for more Key Holders

Inch

Snap Hooks / Swivels

Pouce

Crochets à pression / Émerillons

SPRING SNAPS



Round Eye

Snap Body: tough Zinc Die-Cast, or Cast Malleable Iron, at our option.
Finish: Nickel, Cadmium or Bright Zinc (our option).

SPAENAUR No.	Size of Eye	Length Overall	Ring Size Snap Opening	PKG QTY.
MH-81	5/8"	3-1/8"	7/16"	10
121-233	3/4"	3-11/16"	7/16"	10

SPRING SNAPS

Nickel Plated

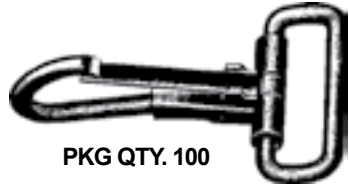

PKG QTY. 100

SPAENAUR No.	Loop Width	Length Overall	Ring Size Snap Opening	Material
121-C60-1K	1-1/8"	2-1/4"	3/16"	Steel Wire
MH-119	1-1/2"	2-1/8"	3/16"	Steel Wire



Loop Eye

Material and Finish: as described above.

SPAENAUR No.	Size of Eye	Length Overall	Ring Size Snap Opening	PKG QTY.
MH-110	7/8"	3-1/8"	.283"	25
MH-111	1"	3"	.283"	25
MH-43	2"	3-1/2"	.306"	5

SPRING SNAPS

Sheet Steel Body Swivel Eye



Sheet Steel Eye

Nickel Plated

SPAENAUR No.	Size of Eye	Length Overall	Ring Size Snap Opening	Snap Body Component
121-C40-1A	3/8"	2-3/4"	1/4"	(MH-86)

PKG QTY. 100





Swivel Round Eye

Material and Finish: as described above.

SPAENAUR No.	Size of Eye	Length Overall	Ring Size Snap Opening	PKG QTY.
MH-82A	5/8"	3-1/8"	1/4"	25
121-526	5/8"	3-3/8"	3/8"	25
MH-83	3/4"	3-1/2"	3/8"	25
MH-84	1"	3-3/4"	3/8"	25

SNAP BODIES

Sheet Steel Nickel Plated

SPAENAUR No.	Length Overall	Ring Size Snap Opening
MH-87	1-1/4"	7/32"
MH-86A	1-9/16"	3/16"
MH-86	1-3/4"	1/4"

PKG QTY. 100



Swivel Eye

Cast Solid Brass - Nickel Plated



SPAENAUR No.	Size of Eye	Length Overall	Ring Size Snap Opening	PKG QTY.
MH-52	3/8"	1-7/8"	.175"	25

Cast Malleable Iron - Nickel Plated

121-192	3/8"	2-1/2"	3/16"	25
---------	------	--------	-------	----

SWIVELS

Steel Nickel Plated





SPAENAUR No.	Size of Eye
MH-143	3/8" Eye
MH-145	1/2" Eye

PKG QTY. 100

SWIVELS

Tough Zinc Die-Cast Nickel Plated



SPAENAUR No.	Size of Eye	Length Overall	Use with Snap Opening	PKG QTY.
121-247	1/2"	1-15/16"	5/32"	25
121-248	5/8"	2-3/8"	3/16"	25
121-249	3/4"	2-5/8"	3/16"	10
121-250	1"	3"	7/32"	10

CATALOG 14 SPAENAUR

Non-critical measurements in catalog are for reference only.

© 2018 Spaenaur Inc. All rights reserved. Catalog may not be reproduced, in whole or in part, without the written permission of Spaenaur Inc. Subject to Catalog Terms and Conditions of Use available at Spaenaur.com and on page TC2 and TC3 at the back of this catalog.
 © 2018 Spaenaur Inc. Tous droits réservés. Le catalogue ne peut être reproduit, en tout ou en partie, sans l'autorisation écrite de Spaenaur Inc. L'utilisation est soumise aux Conditions d'utilisation du Catalogue disponibles sur Spaenaur.com et à la page TC4 et TC5 à la fin de ce catalogue.

M51

Snap Hooks / Pulleys

Inch

Crochets à pression / Poulies

Pouce

SNAPS

Cast Brass

Plain Finish

90° Fast Eye



SPAENAUR No.	I.D. of Eye	Length Overall	Ring Size Snap Opening	PKG QTY.
MH-67	5/8"	2-7/8"	5/16"	10
121-025	3/4"	3-7/8"	5/8"	10

TRIGGER SNAPS

Swivel Eye

Zinc Die-cast
or
Cast Malleable Iron
- at our option.

Nickel Plated

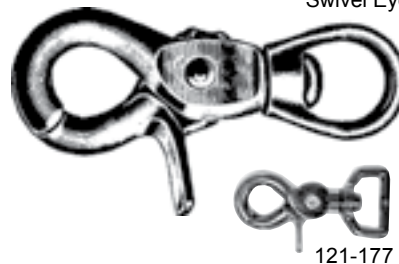

121-177

SPAENAUR No.	Size of Eye	Length Overall	Ring Size Snap Opening	PKG QTY.
121-179	3/8"	2-3/8"	3/8"	10
121-180	1/2"	2-1/2"	3/8"	10
121-177	3/4" x 1/4"	2-3/8"	3/8"	10
121-181	5/8"	2-3/8"	3/8"	10
121-182	3/4"	2-7/8"	3/8"	10

Our buckles, snaps, hooks and pulleys are manufactured to either Inch or Metric specifications and shown accordingly in our catalog.

By using the Inch/Metric Conversion Chart on page R3 in the back of the Spaenaur catalog, your selection can be expanded by simple conversion to choose from both Inch and Metric items.

The R section also contains information relating to Equivalent Standard Bolt Diameters, Torque Conversion Charts and Tension Loads / Tightening Torques.

SAFETY SNAP HOOKS

Fast Eye



Weldless Drop Forged Steel
Galvanized Finish

With Stainless Steel Spring and Rivet or Screw and Nut Assembly.

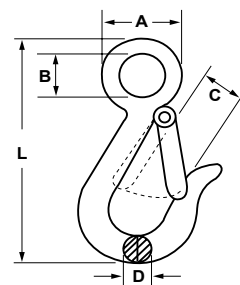

SPAENAUR No.	A	B	C	D	L	Safe Work Ld.	PKG QTY.
121-049	1-1/4"	3/4"	3/4"	7/16"	3-15/16"	750 lbs.	10
121-050	2"	1-1/8"	13/16"	9/16"	4-3/4"	1000 lbs.	5

For trailer winches, etc. Also used on conveyors.

PULLEY with Swivel Eye

For 9/32" (7 mm) Rope Dia.

SPAENAUR No.

121-422

Body: Die Cast, Nickel Plated
Roller: Die Cast, Brass Plated

Overall Length: 2-3/8"
Roller O.D: 1"

PKG QTY. 10



M

Metric

Snap Hooks / Pulleys

Métrique

Crochets à pression / Poulies

Snap Hooks of Half Round Steel Wire

with Swivel Eye

Metric

Nickel Plated

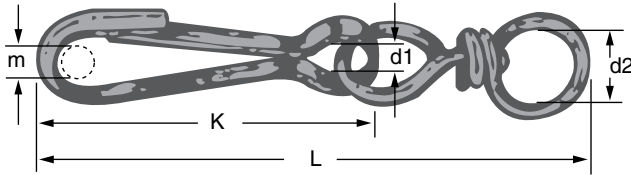

Dimensions in Millimetres.

SPAENAUR No.	d1	d2	m	K/L	PKG QTY.
121-079	5.5	8	3.5	25/50	100
121-080	6	8	4.5	30/55	100
121-081	6.5	8	5	35/60	100
121-082	7	10	5.5	40/67	100
121-084	9	11	6.5	50/83	50
121-085	10	13	7.5	60/97	50
121-086	11	17	9	70/115	50
121-087	12	17	10	80/123	25
121-088	13	19	10.5	90/140	25

SPRING SNAP BODY ONLY

Stainless Steel, Plain Finish

SPAENAUR No.	d1	d2	m	K	PKG QTY.
121-841	7	-	5.5	40	50

PULLEYS

Body: Tough Die Cast Zinc

Roller: Nylon

PKG QTY. 10



SPAENAUR No.	Roller Dia. mm	Rope Dia. mm	O/A Lgth. mm
121-241	15	5	50
121-240	20	6	60
121-242	25	7	70
121-243	30	8	80

FIREMAN'S SNAP

Made of ROUND STEEL WIRE

ZINC PLATED

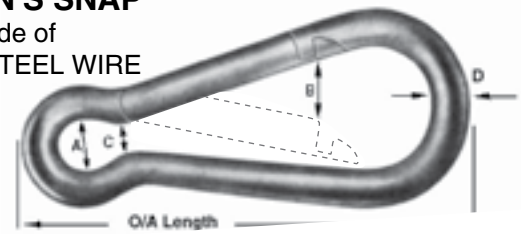

SPAENAUR No.	Dimensions			O/A Length mm	Dia. D mm	PKG QTY.
	A mm	B mm	C mm			
121-129	8	7	4	50	5	10
121-130	10	8	6	60	6	10
121-244	13	11	9	80	8	10
121-132	13	11	10	90	9	10
121-245	16	12	11	100	10	10
121-246	16	17	12	120	11	10
121-133	20	21	14	140	12	10
121-134	22	28	16	160	13	10
121-135	22	42	16	180	14	5
121-136	26	43	16	200	15	5

For Wire Clamps & Thimbles see Page M55

THIMBLES



MANILLA ROPE THIMBLES



WIRE ROPE CLAMPS



See page M50 for more Belt Snaps

Snap Hooks

Crochets à pression

Metric

Métrique

SNAP HOOK



SOLID BRASS

SPAENAUR No.	Size of Eye mm (inch)	Snap Opening mm	Overall Length mm	PKG QTY.
121-119	16 (5/8)	—	80	10
121-120	20 (3/4)	—	80	10

SNAP HOOKS

ZINC DIE CAST

Nickel Plated



Swivel Eye

DIN 5289

SPAENAUR No.	Size of Eye mm	Length Overall mm	Ring Size Snap Opening mm	PKG QTY.
121-223	10	55	10	10
121-224	15	65	12	10

SNAP HOOK

of

DROP FORGED STEEL

Bright Zinc Plated

Break Strength: 3600 lbs.



SPAENAUR No. 121-C63-1X

Eye Diameter	Overall Length	PKG QTY
17 mm	90 mm	10

SNAP HOOKS

DROP FORGED ZINC PLATED

Style 1

DIN 5299E

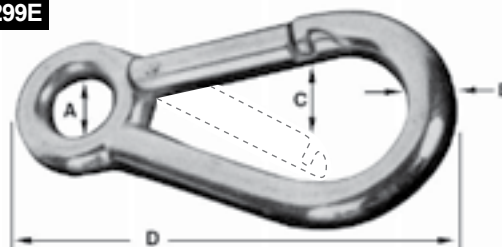

Boat Snaps

ZINC DIE CAST

Zinc or Nickel Plated - our option.



Fast Eye

SPAENAUR No.	Size of Eye mm	Length Overall mm	Ring Size Snap Opening mm	PKG QTY.
121-423	11	50	7	10
*121-236	12	60	8	10
MH-153	15	70	10	10
MH-154	16	85	12	10
121-C39-1P	17	100	15	10
*121-237	24	120	18	10

*Cast Malleable Iron

Style 2

with threaded collar



SNAP HOOK



SOLID BRASS

SPAENAUR No.	Size of Eye mm (inch)	Snap Opening mm	Overall Length mm	PKG QTY.
121-121	16 (5/8)	—	70	10
121-122	20 (3/4)	—	95	5

SPAENAUR No.	Style	Eye Dia. A mm	Steel Thck. B mm	Snap Opening C mm	O/A Lgth. D mm	PKG QTY.
121-123	1	9	6	8	60	5
121-C02-1A	1	10	7	8	70	5
121-424	1	15	10	13	100	1
121-C31-1C	2	15	10	13	100	1

M

CATALOG 14

SPAENAUR

M54