

Deep-Reach Magnetic Threaded Plug / Pressure Pipe Plugs

Bouchons filetés aimantés à longue portée / Bouchons de tuyau sous pression



Inch
Pouce

DEEP-REACH ASSEMBLIES

DEEP-REACH ASSEMBLIES are designed to provide magnetic protection for large capacity lube or hydraulic systems. Greater magnetic capability is accomplished by stacking several magnets on a post or inside a thin stainless steel or brass tube. This type of construction projects the chip collection area farther into the system and closer to the areas of chip generation.

The tube method of construction is used primarily on applications that require frequent inspection and cleaning. The "magnetic tube" is easily wiped off. Spacers between the magnets in the tube concentrate the magnetic fields and increase the holding capacity of the unit.

PKG QTY. 1

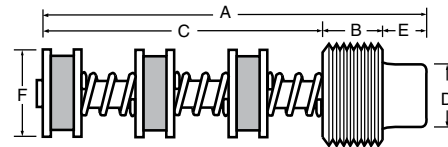
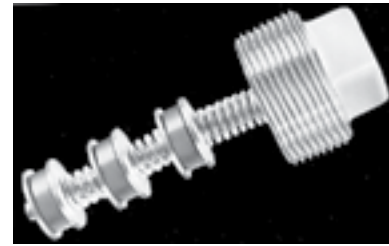

SPAENAUR No.	Thread Size & Class	No. of Magnets Style & Material	A Overall Nominal Length In. (mm)	B Thread Length In. (mm)	C Magnet Projection In. (mm)	D Head Size In. (mm)	E Head Height In. (mm)	F Magnet Assembly Diameter In. (mm)	Body Material
246-211	3/4"-14 NPTF	3-Disc, Ceramic I	4-3/16" (106.3)	5/8" (15.9)	3" (76.2)	5/8" (15.9)	7/16" (11.1)	7/8" (9.7)	Steel
246-212	1"-11-1/2 NPTF	3-Disc, Ceramic I	4-1/4" (108.0)	3/4" (19.1)	3" (76.2)	13/16" (20.6)	17/32" (13.5)	7/8" (9.7)	Cast Iron
246-213	1-1/4"-11-1/2 NPTF	3-Disc, Ceramic I	4-11/32" (110.3)	13/16" (20.6)	3" (76.2)	15/16" (23.8)	17/32" (13.5)	7/8" (9.7)	Cast Iron

H

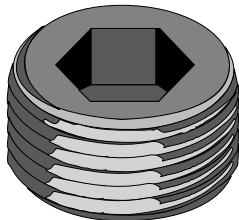

Hex Socket Pressure Pipe Plugs

Dryseal - NPTF - 3/4" Taper Per Foot
Alloy Steel, Stainless Steel and Brass

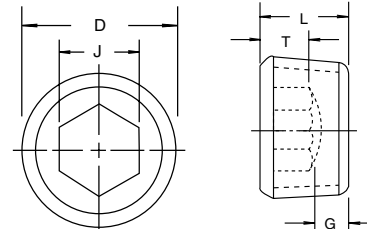

* Stainless steel hex socket plugs can be ± 10% on the max. overall length

Material	SPAENAUR No.	Nom. Size	D Nom. O.D.	Threads Per Inch	J Hex-Socket Size Nom.	T Key Engagement Min.	G Wall Thickness Min.	L Overall Length			PKG QTY.
								Nom.	*Max.	Min.	
Alloy Steel	246-120	1/16"	.312"	27	5/32"	.140"	.062"	5/16"	.324"	.300"	100
	246-121	1/8"	.405"	27	3/16"	.140"	.062"	5/16"	.324"	.300"	100
	246-122	1/4"	.540"	18	1/4"	.218"	.073"	7/16"	.457"	.417"	100
	246-A13-1X	3/8"	.675"	18	5/16"	.250"	.084"	1/2"	.520"	.480"	100
	246-124	1/2"	.840"	14	3/8"	.312"	.095"	9/16"	.583"	.542"	50
	246-125	3/4"	1.050"	14	9/16"	.312"	.125"	5/8"	.645"	.605"	25
	246-126	1"	1.315"	11-1/2	5/8"	.375"	.125"	3/4"	.770"	.730"	10
246-127	1-1/4"	1.660"	11-1/2	3/4"	.437"	.156"	13/16"	.832"	.792"	5	
Stainless Steel	246-A03-1P	1/16"	.312"	27	5/32"	.140"	.062"	17/64"	.324"	.300"	10
	246-805	1/16"	.300"	27	5/32"	.129"	.140"	9/32"	.324"	.300"	10
	246-A04-1Y	1/8"	.405"	27	3/16"	.140"	.062"	17/64"	.457"	.417"	10
	246-A05-1C	1/4"	.540"	18	1/4"	.218"	.073"	13/32"	.520"	.480"	10
	246-A06-2N	3/8"	.675"	18	5/16"	.250"	.084"	13/32"	.425"	.395"	5
Brass	246-500	1/16"	.312"	27	5/32"	.140"	.062"	19/64"	.310"	.290"	100
	246-501	1/8"	.405"	27	3/16"	.140"	.062"	19/64"	.310"	.290"	10
	246-502	1/4"	.540"	18	1/4"	.218"	.073"	15/32"	.475"	.445"	10
	246-503	3/8"	.675"	18	5/16"	.250"	.084"	15/32"	.475"	.445"	10
	246-504	1/2"	.840"	14	3/8"	.312"	.095"	5/8"	.630"	.590"	5

CATALOG 14

SPAENAUR

Inch and Metric

Pouce et Métrique



Pipe Plugs Short / Screw Plugs Parallel Threads

Bouchons de tuyau courts / Bouchons vissés à filets parallèles

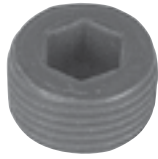

DIN 906

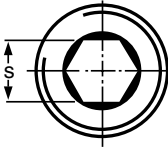
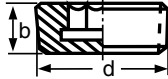

Hexagon Socket

PIPE PLUG

SHORT TYPE
with Metric Fine Tapered Threads
(In accordance with DIN 158)

Plain STEEL

SPAENAUR No. suffix letters indicate:
YZ - Yellow Zinc Plated, ZP - Zinc Plated

DIMENSIONS IN MILLIMETRES

SPAENAUR No.	d Dia. x Pitch	b Thickness	s Width A/F	PKG QTY.
246-220	M8 x 1	8	4	100
246-221	M10 x 1	8	5	100
246-222	M12 x 1.5	10	6	100
246-223	M14 x 1.5	10	7	50
246-224	M16 x 1.5	10	8	50
246-224YZ	M16 x 1.5	10	8	50
246-224ZP	M16 x 1.5	10	8	50
246-225	M18 x 1.5	10	8	25
246-226	M20 x 1.5	10	10	25
246-227	M22 x 1.5	10	10	10
246-228	M24 x 1.5	12	12	10
246-229	M26 x 1.5	12	12	5
246-230	M30 x 1.5	12	17	5
246-231	M36 x 1.5	15	19	5
246-232	R 1/8"	8	5	100
246-233	R 1/4"	10	7	50
246-234	R 3/8"	10	8	25
246-235	R 1/2"	10	10	10
246-236	R 3/4"	12	12	5
246-237	R 1"	12	17	5

Hexagon Socket PIPE PLUG

SHORT TYPE
with Whitworth Tapered Threads
(In accordance with DIN 3858)

Plain STEEL

With Shoulder

DIN 908

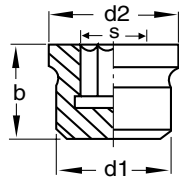

Hexagon Socket
SCREW PLUG

with Parallel Screw Threads

Metric Fine Thread

(In accordance with DIN 13)

Plain STEEL

(See box at top of page for plating)

DIMENSIONS IN MILLIMETRES

SPAENAUR No.	d1 Dia. x Pitch	d2 Shoulder	b Thickness	s Width A/F	PKG QTY.
246-A01-1X	M8 x 1	12	10	4	100
246-241ZP	M10 x 1	14	11	5	100
246-243	M14 x 1.5	19	15	6	50
246-244YZ	M16 x 1.5	21	15	8	50
246-244ZP	M16 x 1.5	21	15	8	50
246-245	M18 x 1.5	23	16	8	25
246-246ZP	M20 x 1.5	25	18	10	25
246-247	M22 x 1.5	27	18	10	10
246-A14-1A	M24 x 1.5	29	18	12	10
246-249	M26 x 1.5	31	20	12	5
246-A15-1P	M30 x 1.5	36	20	17	5
246-251	M36 x 1.5	42	21	19	5
246-A02-1A	G 1/4"A	18	15	6	50
246-A08-1K	G 1/2"A	26	18	10	10
246-256	G 3/4"A	32	20	12	5
246-257	G 1"A	39	21	17	5
246-258	G 1-1/4"A	49	21	22	5

Hexagon Socket
SCREW PLUG

with Parallel Screw Threads

Whitworth Pipe Thread

(In accordance with DIN ISO 228)

Plain STEEL

Pipe Plugs Short / Grease Fitting Adaptors

Metric

Bouchons de tuyau courts / Adapteurs d'embout de graissage

Métrique

DIN 7604 A

A = Short Thread

HEX HEAD PIPE PLUGS

with Shoulder

Class 5.8 STEEL, Plain Finish
Parallel Metric Fine Thread

Suffix: ZP = Zinc Plated
YZ = Yellow Zinc Plated

Metric / Métrique

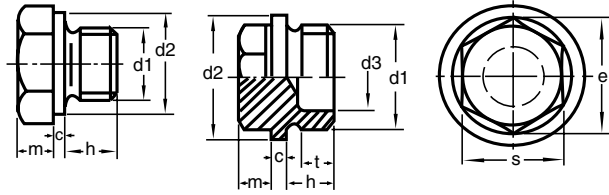

DIN 7604A Short Thread

SPAENAUR No.	d1 Dia. x Pitch	c	d2	d3	t	h short	m	s	e	PKG QTY.
246-119	M12 x 1.5	1.5	17	—	—	9	6	17	18.9	10
246-119ZP	M12 x 1.5	1.5	17	—	—	9	6	17	18.9	10
246-332	M14 x 1.5	1.5	19	—	—	9	6	19	21.1	1
246-332ZP	M14 x 1.5	1.5	19	—	—	9	6	19	21.1	1
246-333ZP	M16 x 1.5	1.5	21	—	—	9	6	22	24.49	1
246-309ZP	M30 x 1.5	2.5	36	20	10	9	8	22	24.49	1
246-309YZ	M30 x 1.5	2.5	36	20	10	9	8	22	24.49	1

H

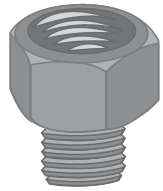

Metric Conversion

Adaptors

STEEL - Zinc Plated

Fit Metric Threads listed below
converting them to
1/4" - 28 UNF
Standard Internal Thread.

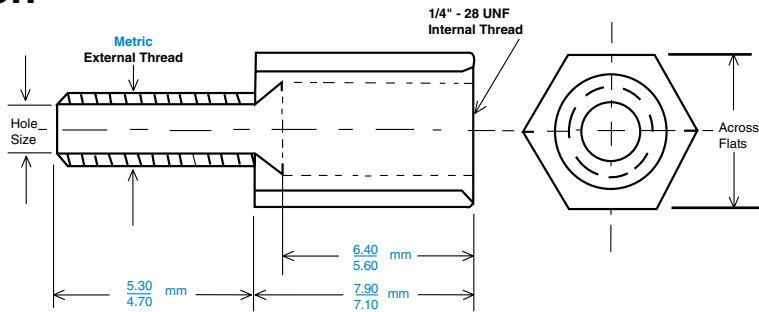

SPAENAUR No.	External Thread Dia. x Pitch	Across Flat (mm)	Stud Hole Size (mm)	PKG QTY.
113-010	M6 x 1.00 mm	9.5 / 8.79	3.00 / 2.90	25
113-011	M8 x 1.00 mm	9.5 / 8.79	3.40 / 3.20	25
113-012	M10 x 1.00 mm	11.15 / 10.95	3.80 / 3.60	25

NEW



Threadlocker prevents threaded fasteners from coming loose due to shock and vibration.

See Page B4