

Inch

Hitch Pins

Pouce

Goupilles d'attelage

BENT PULL PINS

PKG QTY. 10

Designed for use on Farm Equipment; Lawn and Garden Equipment; Recreational Vehicles and on Mobile Home Trailer Hitches.

Steel C-1117

SPAENAUR No.	Diameter	Approx. Usable Length
233-F43-1N	1/2"	3"
233-233	5/8"	3"
233-F45-1K	3/4"	3-1/2"
233-235	3/4"	4-1/2"

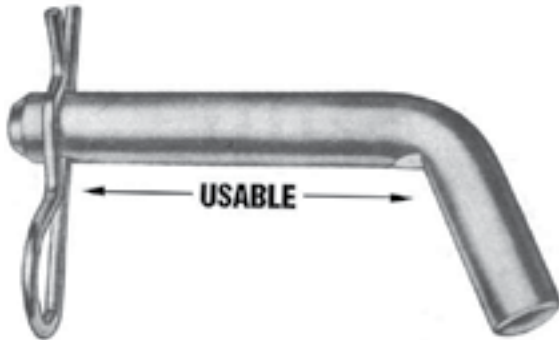

- Made from high strength steel.
- **Heavy zinc plating** resists rust.
- Fits all popular trailer hitches.
- Each pin complete with hairpin.

TAB LOCK PINS



C1018 Case Hardened **Steel**,
Zinc Plated

SPAENAUR No.	Diameter	Approx. Usable Length	PKG QTY.
233-085	1/4"	1-3/4"	10
233-086	5/16"	1-3/4"	10
233-087	3/8"	1-3/4"	10

TENSION LOCK HITCH PINS

PKG QTY. 10

Steel C-1144 Stress Relieved

Tension Spring Holds Toggle Lock Where You Put It Locked...or Unlocked - For Easy One-Hand Use!

Specifically designed for quick hitching (and unhitching) all types of mobile equipment. Machined from high strength steel. **Zinc Plated.** A Safe-Sure Hitch Pin.

SPAENAUR No.	Diameter	Approx. Usable Length
233-226	3/8"	2-3/4"
233-F44-1T	1/2"	3-1/2"
233-216	5/8"	3-1/2"
233-217	3/4"	3-1/2"
233-218	7/8"	3-1/2"
233-219	1"	3-1/2"
233-220	3/4"	6"
233-221	7/8"	6"
233-222	1"	6"
233-223	13/16"	6-1/4"

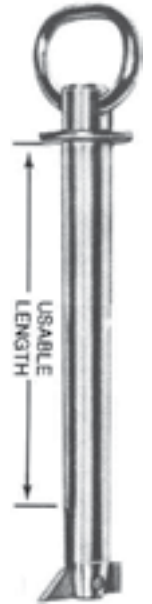

PIN-LOCK

HAIRPIN PROVIDES POSITIVE LOCKING.

EACH PIN COMPLETE WITH HAIRPIN.

PIN-LOCK HAIR PIN HITCH PIN

For heavy mobile equipment.

Steel

C-1144 Stress Relieved

Zinc Plated

SPAENAUR No.	Dia.	Approx. Usable Length	PKG QTY.
233-245	3/8"	3"	10
233-246	1/2"	4"	10
B-2005	5/8"	4-1/2"	5
B-2006	3/4"	4-1/2"	10
233-F46-1W	1"	4-1/2"	1
B-2008	5/8"	6"	10
B-2009	3/4"	6"	10
B-2010	7/8"	6"	10
B-2011	1"	6"	1



Hitch Pins

Inch

Goupilles d'attelage

Pouce

**FAST-POSITIVE SAFETY LOCKING PINS
MULTI-PURPOSE**

For Farm, Campers, Boats,
Trailers, Snowmobiles,
Lawn & Garden Equipment.

STEEL - Zinc Chromate Plated
(Yellow or Clear - Our Option) and
STAINLESS STEEL
300 Series

LOCK PINS

Available in STEEL
Zinc Chromate Plated
(Yellow or Clear - Our Option)
and 300 Series
STAINLESS STEEL

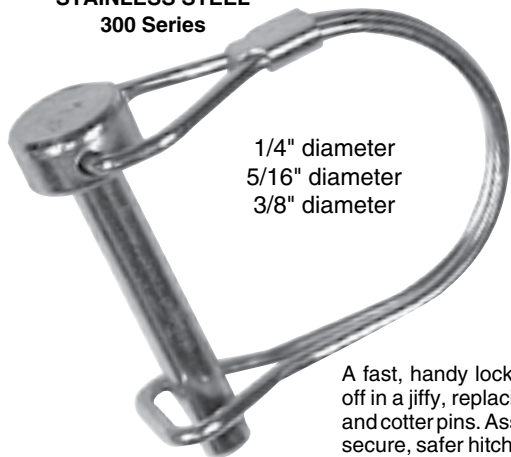

1/4" diameter
5/16" diameter
3/8" diameter

A fast, handy lock pin, on and off in a jiffy, replacing frail bolts and cotter pins. Assures a more secure, safer hitch. Saves time and temper. Positive locking.

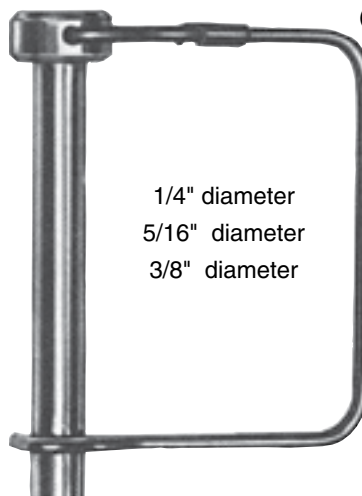

1/4" diameter
5/16" diameter
3/8" diameter

Steel
C-1010 - C-1018
Precision formed from high strength premium steel. Oil-tempered spring stays securely snap-locked. Heavy zinc plated to resist rust.

For all PTO powered equipment - fits all PTO knuckles and most adapters.

Steel C-1010/C-1018 Zinc Chromate Plated

Steel C-1010/C-1018 Zinc Chromate Plated

SPAENAUR No.	Diameter	Usable Length	PKG QTY.
233-239	1/4"	1-3/8"	10
233-F61-1X	1/4"	1-3/4"	10
233-241	5/16"	1-3/8"	10
233-242	5/16"	1-3/4"	10
B-1996	3/8"	1-3/8"	10
233-243	3/8"	2-1/2"	10

SPAENAUR No.	Diameter	Usable Length	PKG QTY.
233-F41-1C	1/4"	2-1/2"	10
B-1997	5/16"	2-1/2"	10
233-F42-1N	3/8"	2-1/4"	10
233-F48-1A	3/8"	2-1/2"	10
233-250	1/2"	3"	10

300 Series Stainless Steel

300 Series Stainless Steel			
233-F78-1N	1/4"	1-3/8"	10
233-940	1/4"	1-3/4"	10
233-F47-1X	5/16"	1-3/8"	10
233-944	5/16"	1-3/4"	10
233-947	3/8"	1-3/8"	10
233-948	3/8"	1-3/4"	10

233-941	1/4"	2-1/4"	10
233-942	1/4"	2-1/2"	10
233-945	5/16"	2-1/4"	10
233-946	5/16"	2-1/2"	10
233-949	3/8"	2-1/4"	10
233-950	3/8"	2-1/2"	10

SNAP-LOCK HITCH PINS

Steel C-1144
Stress Relieved
Heavy Zinc Plated

TEMPERED
SPRING-STEEL
SNAP STAYS LOCKED

SPAENAUR No.	Diameter	Usable Length	PKG QTY.
233-214	1/2"	3-1/2"	5
233-257	5/8"	4"	5
233-258	3/4"	4"	1
233-259	3/4"	6"	1
233-260	7/8"	5-1/2"	1
233-261	1"	5-1/2"	1

All
Popular Sizes
1/2", 5/8", 3/4", 7/8", 1"

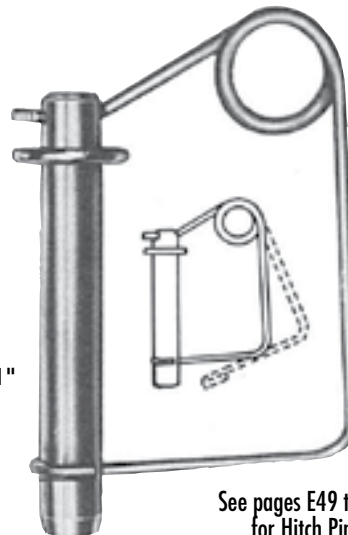

See pages E49 to E62
for Hitch Pin Clips

E

CATALOG 14

SPAENAUR

Inch

Hitch Pins

Pouce

Goupilles d'attelage

HEAVY DUTY HITCH PINS

- PRECISION MACHINED
- C-1144 STRESS RELIEVED STEEL
- ZINC PLATED
- VINYL COATED HANDLE
- INCLUDES HAIR PIN CLIP

SPAENAUR No.	Dia.	Approx. Usable Lgth.	PKG QTY.
*233-070	1/2"	4"	1
233-071	5/8"	4-1/2"	1
233-072	3/4"	4-1/2"	1
233-073	7/8"	4-1/2"	1
233-023	1"	6-1/2"	1
233-074	1"	4-1/2"	1
233-075	5/8"	6"	1
233-076	3/4"	6-1/2"	1
233-077	7/8"	6-1/2"	1
233-023	1"	6-1/2"	1
233-079	1-1/8"	7"	1
233-080	1-1/4"	7"	1



*233-248 Slightly different shape to the handle; see illustration.

STEEL

Material: 4130 Alloy

Finish: Yellow Zinc Plated

"QR" HITCH PINS

Quick Release Ball Lock Pins

T - HANDLE

with push button release.

The T-handle of aluminum alloy allows for better gripping and use where force is needed for insertion and removal of pin.

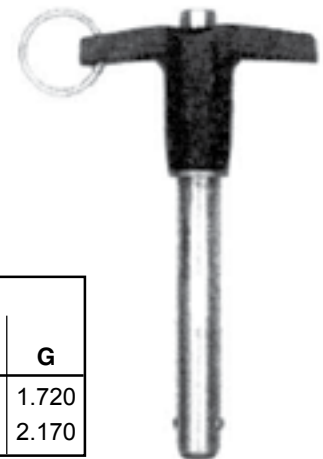
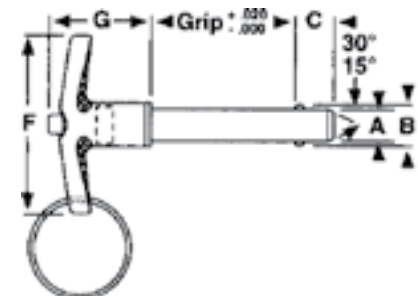

SPAENAUR No.	PKG QTY.	A Shank Dia.(Nom.)	Recommended Hole Size	Dimensions in Inches				
				Grip	B	C	F	G
233-350	1	3/4"	.757/1.750	3.5	.887	.670	3.10	1.720
233-351	1	1"	1.010/1.000	4.0	1.219	.890	3.52	2.170

Other sizes & grip lengths in stainless steel available on special order. L-Handle Style also available upon request.

Hitch Pins

Inch

Goupilles d'attelage

Pouce

STEEL

Material: C 1144

Finish: Zinc Plated

STAINLESS STEEL

Ring: 303 St. Steel

Body: 302 St. Steel

REGULAR STYLE

Quick Release Pins

with Spring loaded ball

Steel and Stainless Steel

Time Saving

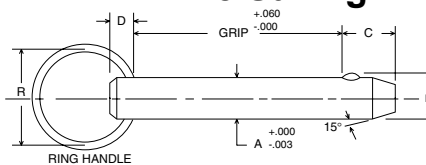

(No shoulder)

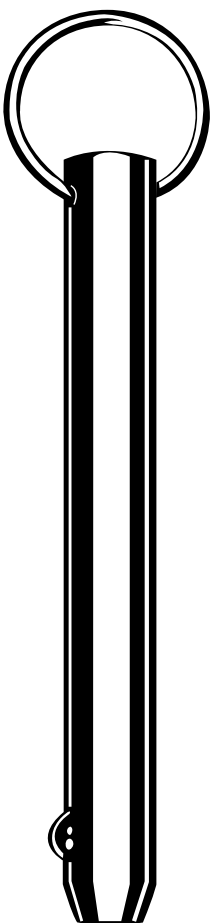

STEEL	SPAENAUR No.			A SHANK DIA.	GRIP (inches)	Dimensions in inches			
	PKG QTY.	STAINLESS STEEL	PKG QTY.			B	C	D	R
233-264	25	233-800	25	3/16"	1.00	.200	.200	.187	1.00
233-265	25	233-801	25		1.30				
233-266	25	233-802	25		1.80				
233-267	25	233-803	25		2.30				
233-268	10	233-804	10	1/4"	1.00	.286	.312	.250	1.00
233-269	10	233-805	10		1.30				
233-270	10	233-806	10		1.80				
233-271	10	233-807	10		2.30				
233-272	10	233-808	10		2.80				
233-273	10	233-809	10		3.20				
233-F17-1T	10	233-810	10		3.80				
233-276	10	233-811	10	5/16"	1.00	.358	.375	.250	1.00
233-277	10	233-812	10		1.20				
233-279	10	233-813	10		1.60				
233-F89-1C	10	233-814	10		2.30				
233-275	10	—	—		2.80				
		233-951	10	3.5					
233-287	10	233-815	10	3/8"	1.30	.426	.500	.250	1.00
233-288	10	—	—		1.60				
233-280	10	—	—		1.80				
233-289	10	233-817	10		2.50				
233-290	10	233-818	10		3.0				
233-291	10	233-819	10		3.50				
233-292	10	233-820	10		4.0				
233-297	10	233-821	5	7/16"	1.10	.496	.562	.250	1.00
233-298	10	233-822	5		1.50				
233-299	10	233-F49-1P	5		2.00				
233-F54-1N	10	233-824	5	1/2"	1.5	.570	.625	.312	1.25
233-309	10	233-825	5		2.0				
233-310	5	233-826	5		2.5				
233-311	5	233-827	5		3.0				
233-312	5	233-828	5		3.5				
233-313	5	233-829	5		4.0				
233-314	5	233-830	5		4.5				
233-315	5	233-831	5		5.0				
233-324	5	—	—		5/8"				
233-325	5	—	—	3.0					
233-323	5	233-832	1	3/4"	1.6	.856	.937	.375	1.50
96737	1				2.25				

E

CATALOG 14

SPAENAUR

Inch

Hitch Pins

Pouce

Goupilles d'attelage

STEEL

Material: C 1144
Finish: Zinc Plated

— and —

STAINLESS STEEL

Centreless Ground
Ring: 303 Stainless Steel
Body: 302 Stainless Steel

“QR” HITCH PINS with spring loaded ball

Quick Release Pins

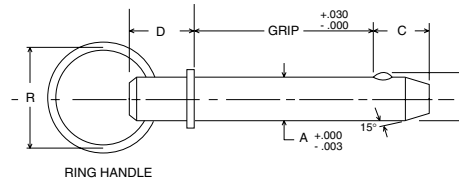

SHOULDER STYLE

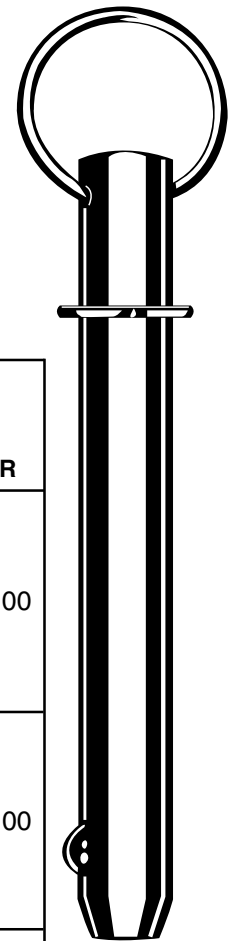

Spaenaur No. STEEL	Approx. Single Shear Lbs.	PKG QTY.	Spaenaur No. STAINLESS STEEL	Approx. Single Shear Lbs.	PKG QTY.	A SHANK Dia.	Dimensions in Inches				
							GRIP	B	C	D	R
233-F98-1A	4320	10	233-970	4870	5	1/4"	1.0	.286	.312	.750	1.00
233-405		10	233-971		5		1.3				
233-406		10	233-972		5		1.8				
233-407		10	233-973		5		2.3				
233-408		10	233-974		5		2.8				
233-409	9740	10	233-975	11020	5	3/8"	1.3	.426	.500	.750	1.00
233-410		10	233-976		5		1.6				
233-411		10	233-977		5		1.8				
233-412		10	233-978		5		2.5				
233-413		10	233-979		5		3.0				
233-414	17290	5	233-980	19560	1	1/2"	1.5	.570	.625	1.062	1.25
233-415		5	233-981		1		2.0				
233-416		5	233-982		1		2.5				
233-417		5	233-983		1		3.0				
233-418		5	233-984		1		3.5				
233-419	5	233-985	1	4.0							
233-316	27330	5	233-833	30850	1	5/8"	4.0	.710	.750	1.125	1.25
233-317		5	233-834		1		5.75				
233-318	39020	5	233-835	44020	1	3/4"	4.0	.856	.937	1.375	1.50
233-319		5	233-836		1		6.25				
233-322	53080	1	233-837	58970	1	7/8"	4.5	.996	1.000	1.500	1.50
233-320		1			1		7.0				
233-321	70190	1	233-839	79340	1	1"	7.0	1.140	1.250	1.500	1.50

... used in construction, agricultural, marine, road, oil and mining machinery to secure bracket assemblies and facilitate change of attachments or accessories.

- Trouble-free operation; easy, one-hand removal
- Dependable holding power in all applications
- Eliminate need for cotter pins and tools
- Solid body construction, high shear strength
- Permit quick fastening and disassembly
- Other Grip Lengths available on Special Order

CATALOG 14 SPAENAUR