

Hex Nuts / Square Nuts

Inch

Écrous hexagonaux / Écrous carrés

Pouce

	THREAD	WIDTH ACROSS FLATS	THICKNESS	STEEL	BRASS	STAINLESS	ALUMINUM
				Zinc Plated	Plain	STEEL	(Alloy 6061-T6)
				ORDER BY SPAENAUR NUMBERS LISTED BELOW			
	0000-160	3/64"	.033"		▲HN-553		
	000-120	5/64"	.033"		▲HN-554		
	00-96	5/64"	.040"		▲HN-165B		
	00-90	5/64"	.040"		▲HN-555		
	0-80	5/32"	3/64"	HN-105	HN-105B	HN-2034	
	1-64	5/32"	3/64"		HN-106B	HN-2028	
	1-72	5/32"	3/64"	HN-107	HN-107B	HN-2027	
	2-56	3/16"	1/16"	155-P07-1N	HN-1B	HN-2000	
	2-64	3/16"	1/16"	HN-230	HN-2B		
	3-48	3/16"	1/16"	HN-3	HN-3B	HN-2001	
	3-56	3/16"	1/16"	HN-4	HN-4B		
	4-36	1/4"	3/32"		HN-5B		
	4-40	3/16"	1/16"	155-P01-1M	HN-20B		
	4-40	3/16"	3/32"		157-002		
	4-40	1/4"	3/32"	155-P11-1K	157-T14-1W	159-W03-2P	HN-3002
	4-48	1/4"	3/32"	HN-7	157-T29-1A		
	5-40	1/4"	3/32"		HN-8B		
	5-40	5/16"	7/64"	HN-205	HN-556	159-W29-1C	HN-3003
	5-44	5/16"	7/64"		HN-526		
	6-32	1/4"	3/32"	B-1521	HN-9B		
	6-32	5/16"	7/64"	155-P03-2A	HN-10B	159-W05-2K	HN-3004
	6-40	5/16"	7/64"	HN-11	HN-11B		
	8-32	1/4"	3/32"	155-P05-1Y	HN-12B	159-027	
	8-32	5/16"	7/64"	155-007	157-T22-1C		
	8-32	11/32"	1/8"	155-P04-1P	157-T17-1A	159-W04-1T	161-A01-1C
	8-36	11/32"	1/8"		157-T08-1C	HN-2036	
	10-24	3/8"	1/8"	155-P08-1T	HN-15B	■159-W19-1T	HN-3001
	10-32	7/16"	5/32"	HN-69			
	10-32	3/8"	1/8"	155-P02-1X	157-T01-2K	159-W15-1P	HN-3017
	12-24	7/16"	5/32"	155-P22-1T	157-T04-1X	159-W28-1Y	HN-3006
	12-28	7/16"	5/32"				
	1/4-20	7/16"	3/16"	155-P06-1C	157-T10-1C	159-W21-1T	161-A05-1W
	1/4-28	7/16"	3/16"	734	HN-23B		
	5/16-18	9/16"	7/32"	735	HN-24B		HN-3019
	5/16-24	9/16"	7/32"	736			
	3/8-16	5/8"	1/4"		157-001		
<div style="border: 1px solid black; padding: 5px; text-align: center;"> PKG QTY. 100 <i>All Above Listed No's.</i> </div> <p>See page C8 for complete listing of Nylon Hex Nuts.</p>				<p>Note: All sizes 0-80 to 5/16" are double chamfer and double ctsk.</p>	<p>▲ASTM B16-58 (Brass Specs.) Note: Mini Sizes 0000 to 1-72 not chamfered, not ctsk. Sizes: 2-56 to 1/4"-20 are double chamfer, double ctsk. Thickness & Width Across Flats to ANSI/ASME B18.2.2</p>	<p>■159-022 316 S.S. Note: Mini Sizes 0-80 to 1-72 are not chamfered, not ctsk. Sizes: 2-56 to 1/4"-20 are double chamfer and double ctsk. Thickness & Width Across Flats to ANSI/ASME B18.2.2</p>	<p>Note: HN-3003 single chamfer only. HN-3019 is single chamfer and double ctsk. Other sizes: 4-40 to 5/16" are double chamfer, double ctsk. Thickness & Width Across Flats to ANSI/ASME B18.2.2</p>

STEEL NOT PLATED	SQUARE NUTS ASME B18.6.3				
	SPAENAUR No.	THREAD SIZE	NUT WIDTH A.F.	NUT THICKNESS	PKG QTY.
 CLASS 2B THREAD *205-002 Zinc Plated	N-103	1/4"-20	7/16"	7/32"	100
	205-K02-1W	5/16"-18	9/16"	17/64"	100
	N-105	3/8"-16	5/8"	21/64"	100
	*205-K01-2K	7/16"-14	3/4"	3/8"	50
	N-107	1/2"-13	13/16"	7/16"	50
	N-109	5/8"-11	1"	35/64"	50
	N-110	3/4"-10	1-1/8"	21/32"	50
	N-111	7/8"-9	1-5/16"	49/64"	25
	N-112	1"-8	1-1/2"	7/8"	25

SQUARE Machine Screw Nuts ASME B18.6.3			
ZINC PLATED		PKG QTY. 100	
SPAENAUR No.	THREAD SIZE	ACROSS FLAT	THICKNESS
N-25	4-40	1/4"	3/32"
N-26	6-32	5/16"	7/64"
N-27	8-32	11/32"	1/8"
N-28	10-24	3/8"	1/8"
N-29	10-32	3/8"	1/8"
B-1548	1/4"-20	7/16"	3/16"
N-183	1/4"-28	7/16"	3/16"

Inch

Hex Nuts

Pouce

Écrous hexagonaux



STEEL HEX NUTS
Finished Full
SAE Grade 2

THREADS are Unified Standard
Class 2B Thread Fit
Available in Plain or Zinc Chromate Plated
ASME B18.2.2

INCH CAP SCREW SIZES

NOMINAL SIZE (Inches)	COARSE THREAD SPAENAUR No.			FINE THREAD SPAENAUR No.			WIDTH ACROSS FLAT	THICKNESS	PKG QTY.
	Plain	Zinc Plated	Thread	Plain	Zinc Plated	Thread			
1/4	155-380	155-379	20	-	-	28	7/16"	7/32"	100
5/16	155-027	155-031	18	-	-	24	1/2"	17/64"	100
3/8	155-029	-	16	-	-	24	9/16"	21/64"	100
1/2	155-226	-	13	-	-	20	3/4"	7/16"	50
5/8	155-382	155-386	11	-	-	-	15/16"	35/64"	50
3/4	155-199	155-383	10	-	-	16	1-1/8"	41/64"	50
7/8	-	155-385	9	-	155-P20-1C	14	1-5/16"	3/4"	25
1	-	-	-	155-003	-	12	1-1/2"	55/64"	25
1-3/8	-	-	-	155-023	-	12	2-1/16"	1-11/64"	5
1-5/8	-	-	5-1/2	-	-	-	2-7/16"	1-25/64"	1
1-3/4	-	-	-	-	-	12	2-5/8"	1-1/2"	1
2-1/4	-	-	4-1/2	-	-	-	3-3/8"	1-59/64"	1



STEEL HEX NUTS
Finished Full
SAE Grade 5

THREADS are Unified Standard
Class 2B Thread Fit
Available in Plain or Zinc Chromate Plated
ASME B18.2.2

NOMINAL SIZE (Inches)	COARSE THREAD SPAENAUR No.			FINE THREAD SPAENAUR No.			WIDTH ACROSS FLAT	THICKNESS	PKG QTY.
	Plain	Zinc Plated	Thread	Plain	Zinc Plated	Thread			
1/4	-	B-91	20	-	155-P36-1W	28	7/16"	7/32"	100
5/16	155-025	B-92	18	-	155-P31-1Y	24	1/2"	17/64"	100
3/8	155-028	B-93	16	-	155-P23-1K	24	9/16"	21/64"	100
7/16	-	155-P39-1A	14	-	B-104	20	11/16"	3/8"	50
1/2	155-225	B-95	13	-	B-105	20	3/4"	7/16"	50
9/16	-	B-96	12	-	155-P47-1K	18	7/8"	31/64"	50
5/8	-	155-P16-1P	11	-	155-P46-1T	18	15/16"	35/64"	50
3/4	155-428	B-98	10	-	B-108	16	1-1/8"	41/64"	50
7/8	-	B-99	9	-	B-109	14	1-5/16"	3/4"	25
1	-	B-100	8	-	B-110	14	1-1/2"	55/64"	25
1-1/8	-	155-348	7	-	155-P10-1T	12	1-11/16"	31/32"	5
1-1/4	-	155-346	7	-	155-P19-1N	12	1-7/8"	1-1/16"	5
1-1/2	-	155-356	6	-	155-P28-1P	12	2-1/4"	1-9/32"	5



HIGH TENSILE HEX NUTS
Finished
SAE GRADE 8
ASME B18.2.2

Heat Treated Class 2B Thread Fit
Plain Finish or Zinc Plated with
Yellow Dichromate Dipped

SIZES 1/4" THROUGH 3/4" ARE COLD FORMED, ROCKWELL C30-32.
7/8" THROUGH 1-1/2" ARE HOT FORMED, ROCKWELL C28-34.

NOMINAL SIZE (Inches)	COARSE THREAD SPAENAUR No.			FINE THREAD SPAENAUR No.			WIDTH ACROSS FLAT	THICKNESS	PKG QTY.
	Plain	Zinc Plated	Thread	Plain	Zinc Plated	Thread			
1/4	-	SAN-1	20	-	SAN-2	28	7/16"	7/32"	100
5/16	-	SAN-3	18	-	SAN-4	24	1/2"	17/64"	50
3/8	SAN-5B	SAN-5	16	-	SAN-6	24	9/16"	21/64"	50
7/16	-	SAN-7	14	-	SAN-8	20	11/16"	3/8"	25
1/2	SAN-9B	SAN-9	13	-	SAN-10	20	3/4"	7/16"	25
5/8	-	SAN-11	11	-	SAN-12	18	15/16"	35/64"	25
3/4	SAN-13B	SAN-13	10	-	SAN-14	16	1-1/8"	41/64"	20
7/8	-	SAN-15	9	-	SAN-16	14	1-5/16"	3/4"	15
1	155-430	SAN-17	8	-	SAN-18	14	1-1/2"	55/64"	10
1-1/8	-	SAN-19	7	-	-	-	1-11/16"	31/32"	5
1-1/4	-	SAN-21	7	-	-	-	1-7/8"	1-1/16"	5
1-1/2	-	SAN-22	6	-	-	-	2-1/4"	1-9/32"	5



CATALOG 14 SPAENAUR

Hex Jam / Heavy Nuts

Inch

Contre-écrous hexagonaux / Écrous épais

Pouce

HEX JAM NUTS Finished Steel ANSI B18.2.2	NOMINAL SIZE (Inches)	COARSE THREAD SPAENAUR No.		FINE THREAD SPAENAUR No.		WIDTH ACROSS FLAT	THICKNESS	PKG QTY.	
			THD.		THD.				
 Class 2B Thread Fit Not Plated *Zinc Plated	1/4	*155-396	20			7/16"	5/32"	100	
	1/4	HN-49	20	HN-59	28	7/16"	5/32"	100	
	5/16	HN-50	18	HN-60	24	1/2"	3/16"	100	
	5/16	*HN-50ZP	18			1/2"	3/16"	100	
	3/8	HN-51	16	HN-61	24	9/16"	7/32"	100	
	7/16	HN-52	14	HN-62	20	11/16"	1/4"	50	
	7/16	*HN-52ZP	14	*155-378	20	11/16"	1/4"	50	
	1/2	HN-53	13	HN-63	20	3/4"	5/16"	50	
	1/2	*155-P29-1Y	13	-	20	3/4"	5/16"	50	
	9/16	HN-54	12	HN-64	18	7/8"	5/16"	50	
	5/8	HN-55	11	HN-65	18	15/16"	3/8"	50	
	5/8	*155-399	11			15/16"	3/8"	50	
	3/4	HN-56	10	HN-66	16	1-1/8"	27/64"	50	
	3/4	*155-397	10			1-1/8"	27/64"	50	
	7/8	HN-57	9	HN-67	14	1-5/16"	31/64"	25	
	7/8	*155-030	9			1-5/16"	31/64"	25	
	1	HN-58	8	HN-68	14	1-1/2"	35/64"	25	
	2-1/4	155-323	4-1/2			3-3/8"	1-13/64"	1	
	HEAVY HEX NUTS Steel ANSI B18.2.2  Class 2B Thread Fit Not Plated *Zinc Plated	1/4	155-P30-1P	20			1/2"	15/64"	100
		5/16	B-122	18			9/16"	19/64"	100
5/16		*155-393	18			9/16"	19/64"	100	
3/8		155-P32-1C	16			11/16"	23/64"	100	
3/8		*155-392	16			11/16"	23/64"	100	
7/16		B-124	14			3/4"	27/64"	50	
1/2		B-125	13			7/8"	31/64"	50	
1/2		*155-387	13			7/8"	31/64"	50	
9/16		B-126	12			15/16"	35/64"	50	
5/8		B-127	11			1-1/16"	39/64"	50	
5/8		*155-394	11			1-1/16"	39/64"	50	
3/4		B-128	10			1-1/4"	47/64"	50	
3/4		*155-391	10			1-1/4"	47/64"	50	
7/8		B-129	9			1-7/16"	55/64"	25	
7/8		*155-395	9			1-7/16"	55/64"	25	
1		B-130	8			1-5/8"	63/64"	25	
1		*155-390	8			1-5/8"	63/64"	25	
1-1/8		HN-43	7			1-13/16"	1-7/64"	25	
1-1/8		*155-389	7			1-13/16"	1-7/64"	25	
1-1/4		HN-42	7			2"	1-7/32"	25	
1-1/4	*155-P41-1A	7			2"	1-7/32"	25		
1-3/8	HN-245	6			2-3/16"	1-11/32"	15		
1-1/2	HN-167	6			2-3/8"	1-15/32"	10		
1-3/4	HN-246	5			2-3/4"	1-23/32"	10		
2	HN-247	4-1/2			3-1/8"	1-31/32"	10		

 2H Nuts PLAIN FINISH For use with B7 Studs & Rods 2H Nuts are used for high temperature, high pressure applications such as pipelines, pressure vessels, valves and controls used in the transmission and storage of oil, gasoline, natural gas, steam and many other chemicals. PHYSICAL PROPERTIES: Specification: ASTM A 194-2H Grade: AISI 1045 or 1050 Heat Treatment: Oil Quench & Temper Hardness: 1-1/2 in. incl. Brinell 248 to 327, over 1-1/2 in. Brinell 212 to 327. See page D3 for ASTM F436 STRUCTURAL WASHERS. See page B289 for B7 Threaded Rod.	SPAENAUR No.	UNC THREAD	ACROSS FLATS	THICKNESS	PKG QTY.
	PLAIN				
	155-200	1/4"-20	1/2"	15/64"	50
	155-201	5/16"-18	9/16"	19/64"	25
	155-P42-1P	3/8"-16	11/16"	23/64"	25
	155-203	7/16"-14	3/4"	27/64"	25
	155-204	1/2"-13	7/8"	31/64"	25
	155-205	5/8"-11	1-1/16"	39/64"	20
	155-206	3/4"-10	1-1/4"	47/64"	10
	155-207	7/8"-9	1-7/16"	55/64"	10
	155-208	1"-8	1-5/8"	63/64"	10
	155-211	1-1/8"-8	1-13/16"	1-7/64"	10
	155-210	1-1/4"-8	2"	1-7/32"	10
	155-P44-1C	1-3/8"-8	2-3/16"	1-11/32"	10
	155-212	1-1/2"-8	2-3/8"	1-15/32"	10
	155-P45-1N	1-5/8"-8	2-9/16"	1-19/32"	10
	155-214	1-3/4"-8	2-3/4"	1-23/32"	10
	155-215	2"-8	3-1/8"	1-31/32"	5

For Hexagon Nuts with LEFT HAND THREADS, see next page.

For HOT GALVANIZED STEEL NUTS, see page C6.

For L9 HEX NUTS and L9 FASTENING SYSTEM, see pages B147 to B150.

Inch

Coupling Nuts / Hex Nuts

Pouce

Écrous de raccord / Écrous hexagonaux

COUPLING NUTS

For joining lengths of threaded rod end-to-end.
Right-hand Threads.

*To be used with THREADED RODS
- see pages B286-B290*

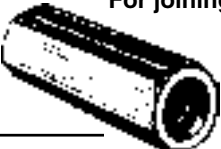

ZINC PLATED STEEL

SPAENAUR No.	Size & Threads Per Inch	Width Across Flats	Length	PKG QTY.
155-301	10-24 UNC	5/16"	3/4"	50
155-300	10-32 UNF	5/16"	3/4"	50
155-302	1/4"-20 UNC	7/16"	7/8"	50
155-359	1/4"-28 UNF	3/8"	7/8"	50
155-303	5/16"-18 UNC	1/2"	1-3/4"	25
155-376	5/16"-18 UNC	5/8"	1-3/4"	25
155-360	5/16"-24 UNF	7/16"	7/8"	25
155-304	3/8"-16 UNC	9/16"	1-3/4"	25
155-361	3/8"-24 UNF	1/2"	1-1/8"	25
155-362	3/8"-24 UNF	5/8"	1-3/4"	25
155-305	7/16"-14 UNC	5/8"	1-3/4"	25
155-363	7/16"-20 UNF	5/8"	1-1/4"	25
155-381	1/2"-13 UNC	11/16"	1-3/4"	25
155-306	1/2"-13 UNC	3/4"	1-3/4"	25
155-364	1/2"-20 UNF	5/8"	1-1/4"	25
155-365	1/2"-20 UNF	11/16"	1-3/4"	25
155-377	5/8"-11 UNC	13/16"	2-1/8"	15
155-307	5/8"-11 UNC	15/16"	2-1/8"	15
155-366	5/8"-18 UNF	13/16"	2-1/8"	15
155-024	3/4"-10 UNC	1"	2-1/4"	15
155-308	3/4"-10 UNC	1-1/8"	2-1/4"	15
155-367	3/4"-16 UNF	1"	2-1/4"	15
155-309	7/8"-9 UNC	1-1/4"	2-1/2"	10
155-368	7/8"-14 UNF	1-1/4"	2-1/2"	10
155-310	1"-8 UNC	1-1/4"	2-1/2"	10
155-369	1"-14 UNF	1-3/8"	2-3/4"	5
155-311	1-1/8"-7 UNC	1-5/8"	3"	5
155-312	1-1/4"-7 UNC	1-5/8"	3"	1
155-370	1-1/4"-12 UNF	1-5/8"	3"	1
155-341	1-1/2"-6 UNC	2"	4"	1
155-371	1-1/2"-12 UNF	2"	3-1/2"	1

Zinc Plated Steel - LEFT-HAND Threads

155-351	3/8"-16 UNC	5/8"	1-3/4"	25
155-352	1/2"-13 UNC	11/16"	1-3/4"	25
155-353	5/8"-11 UNC	13/16"	2-1/8"	15
155-354	3/4"-10 UNC	1"	2-1/4"	15

18-8 Stainless Steel - RIGHT-HAND Threads

155-P37-1M	1/4"-20 UNC	3/8"	7/8"	50
155-801	5/16"-18 UNC	7/16"	1"	25
155-P43-1Y	3/8"-16 UNC	1/2"	1-1/8"	25
155-P35-1K	1/2"-13 UNC	5/8"	1-1/4"	25
155-804	5/8"-11 UNC	7/8"	1-3/4"	10
155-805	3/4"-10 UNC	1"	2-1/4"	10

STEEL Not Plated ASME B18.2.2

DOUBLE THICKNESS NUTS (U.N.F.) FINE THREAD

(FINISHED HIGH HEXAGON NUTS)



THREADS are Unified Standard, Class 2B Fit

SPAENAUR No.	Nominal Size	Thread	Width Across Flats	Thickness	Grade	PKG QTY.
HN-249	1/4"	28	7/16"	3/8"	2	100
HN-250	5/16"	24	1/2"	29/64"	2	100
HN-70	3/8"	24	9/16"	17/32"	5	25
HN-71	7/16"	20	5/8"	39/64"	2	25
HN-72	1/2"	20	3/4"	11/16"	8	25
HN-73	9/16"	18	7/8"	49/64"	8	25
155-P33-1N	5/8"	18	15/16"	27/32"	8	25
155-010	3/4"	16	1-1/16"	1"	8	25
155-009	7/8"	14	1-1/4"	1-5/32"	8	15
HN-77	1"	14	1-7/16"	1-5/16"	8	15
HN-78	1-1/4"	12	1-7/8"	1-11/16"	2	15

GRADE 2 STEEL - Not plated

LEFT-HAND THREAD

ASME B18.2.2



SPAENAUR No.	Thread	Width A.F.	Thickness	PKG QTY.
155-P21-1N	1/4"-20	7/16"	7/32"	100
▲ 155-P27-1A	1/4"-28	7/16"	5/32"	100
* 155-450	1/4"-28	7/16"	5/32"	100
155-P25-1M	5/16"-18	1/2"	17/64"	100
* 155-328	5/16"-24	1/2"	17/64"	100
* 155-326	3/8"-16	9/16"	21/64"	100
* 155-329	3/8"-24	9/16"	21/64"	100
155-327	7/16"-14	11/16"	3/8"	100
155-340	7/16"-20	11/16"	3/8"	100
155-P24-1W	1/2"-13	3/4"	7/16"	50
*▲ 155-026	1/2"-20	3/4"	5/16"	50
*■ HN-241	5/8"-11	1-1/16"	39/64"	50
155-314	5/8"-18	15/16"	35/64"	50
HN-242	3/4"-10	1-1/8"	41/64"	50
*■ 155-347	3/4"-10	1-1/4"	47/64"	50
*▲ 155-358	3/4"-16	1-1/8"	27/64"	50
* 155-429	3/4"-16	1-1/8"	41/64"	50
HN-232	7/8"-9	1-5/16"	3/4"	25
155-349	7/8"-14	1-5/16"	3/4"	25
155-317	1"-8	1-1/2"	55/64"	25
155-318	1-1/8"-7	1-11/16"	31/32"	25
*■ 155-313	1-1/4"-7	2"	1-7/32"	25
155-319	1-1/2"-6	2-1/4"	1-9/32"	10
155-344	1-3/4"-5	2-5/8"	1-1/2"	5
* 155-P34-1T	2"-4	3"	1-23/32"	5

*Grade 5 ▲ Hex Jam Nut ■ Heavy Hex Nut

For Metric Coupling Nuts See page B293.



CATALOG 14 SPAENAUR

Hex Full / Jam Nuts

Inch

Écrous hexagonaux complets / Contre-écrous

Pouce

HEX NUTS		INCH CAP SCREW SIZES			Thickness & Width Across Flats to ANSI/ASME B18.2.2		
NOMINAL SIZE (Inches)	THREAD	DIMENSIONS		SILICON BRONZE	BRASS	PKG QTY.	
		WIDTH A/F	THICKNESS	SPAENAUR	NUMBERS		
Bronze & Brass  Full HEXAGON NUTS	1/4	20 UNC	7/16"	7/32"	157-T23-1N	157-T21-1Y	100
		28 UNF			HN-509	HN-39B	100
	5/16	18 UNC	1/2"	17/64"	HN-502	157-T11-1N	100
		24 UNF			HN-510	157-T20-1P	100
	3/8	16 UNC	9/16"	21/64"	157-T18-1P	157-T15-1M	100
		24 UNF			HN-511	HN-27B	100
	7/16	14 UNC	11/16"	3/8"		*157-T06-1P	50
		20 UNF			HN-512	157-T02-1W	50
	1/2	13 UNC	3/4"	7/16"	157-T13-1K	157-T12-1T	50
		20 UNF			HN-513	157-T03-1M	50
	1/2	13 UNC	7/8"	31/64"	157-008		50
	5/8	11 UNC	15/16"	35/64"	157-T24-1T	▲HN-34B	50
		18 UNF			HN-514	HN-35B	50
	3/4	10 UNC	1-1/8"	41/64"	157-T09-1N	157-T19-1Y	50
		16 UNF			HN-515	157-T26-1W	50
	7/8	9 UNC	1-5/16"	3/4"	HN-507	157-006	25
		14 UNF			HN-516	HN-500	25
	1	8 UNC	1-1/2"	55/64"	HN-508	157-007	25
14 UNF					HN-169B	25	
▲157-009 (1-1/16" Across Flats, 39/64" thick.) *HN-560 (3/4" Across Flats, 23/64" thick.)							
Brass  Finished Jam HEXAGON NUTS Special Jam	1/4	20 UNC	7/16"	5/32"		157-T25-1K	100
		28 UNF				157-T07-1Y	100
	5/16	18 UNC	1/2"	3/16"		HN-532	100
		24 UNF				HN-533	100
	3/8	16 UNC	9/16"	7/32"		HN-534	100
		24 UNF				157-T05-1A	100
	7/16	14 UNC	11/16"	1/4"		HN-536	50
	1/2	13 UNC	3/4"	5/16"		157-T28-1X	50
		20 UNF				HN-539	50
	5/8	11 UNC	15/16"	3/8"		HN-542	50
		18 UNF				HN-543	50
	3/4	10 UNC	1-1/8"	27/64"		HN-544	50
		16 UNF				157-003	50
7/8	9 UNC	1-5/16"	31/64"		HN-546	25	
	14 UNF				HN-559	25	
1	8 UNC	1-1/2"	35/64"		157-T16-1X	25	

STEEL		Hot Galvanized Nuts				
FINISHED HEXAGON		SPAENAUR No.	Thread Size	Across Flats	Thick-ness	PKG QTY.
TAPPED OVERSIZE  UNC COARSE THREAD		155-330	1/4"-20	7/16"	7/32"	100
		155-P12-1K	5/16"-18	1/2"	17/64"	100
		155-332	3/8"-16	9/16"	21/64"	100
		155-333	7/16"-14	11/16"	3/8"	50
		155-334	1/2"-13	3/4"	7/16"	50
		155-P15-1A	5/8"-11	15/16"	35/64"	50
		155-337	3/4"-10	1-1/8"	41/64"	50
		155-338	7/8"-9	1-5/16"	3/4"	25
		155-339	1"-8	1-1/2"	55/64"	25

See page B259 for Galvanized Steel Carriage Bolts.

CATALOG 14

SPAENAUR

Inch

Hex Nuts / Jam Nuts

Pouce

Écrous hexagonaux / Contre-écrous

ASME B18.2.2



CORROSION-RESISTANT

ALUMINUM,

HEX NUTS FINISHED FULL

18-8 and 316 STAINLESS STEEL Inch Sizes

NOMINAL SIZES (Inches)	THREAD	DIMENSIONS		18-8 STAINLESS STEEL	316 STAINLESS STEEL	ALUMINUM (Alloy 6061-T6)	PKG QTY.
		WIDTH ACROSS FLATS	THICKNESS	Thickness & Width Across Flats to ANSI/ASME B18.2.2	Thickness & Width Across Flats to ANSI/ASME B18.2.2		
SPAENAUR NUMBERS LISTED BELOW							
1/4	20 UNC	7/16"	7/32"	159-W02-2A	159-W27-1P	161-A02-1N	100
	28 UNF			159-W07-1T			161-001
5/16	18 UNC	1/2"	17/64"	HN-2011	HN-2302	161-A06-1M	100
	24 UNF			159-W30-1Y			159-W08-1K
3/8	16 UNC	9/16"	21/64"	159-W17-1C	159-W12-1M	161-A04-1K	100
	24 UNF			HN-2020			
7/16	14 UNC	11/16"	3/8"	HN-2013	HN-2304		50
	20 UNF			159-W31-1C			
1/2	13 UNC	3/4"	7/16"	HN-2014	159-W23-1W	161-A03-1T	50
	20 UNF			HN-2022			
1/2	13 UNC	7/8"	19/64"	159-W22-1K			50
1/2	13 UNC	7/8"	31/64"		159-W25-1X		50
9/16	18 UNF	7/8"	31/64"	159-002			50
5/8	11 UNC	15/16"	35/64"	HN-2009	HN-2300	161-A07-1X	50
	18 UNF			HN-2023			
3/4	10 UNC	1-1/8"	41/64"	159-W20-1N	159-W24-1M	HN-3013	50
	16 UNF			HN-2024			
7/8	9 UNC	1-5/16"	3/4"	159-W10-1K	HN-2307		25
	14 UNF			HN-2025			
1	8 UNC	1-1/2"	55/64"	159-W26-1A	HN-2308		25
	14 UNS			HN-2026			
1-1/8	7 UNC	1-11/16"	31/32"	159-W06-1N			20
1-1/4	7 UNC	1-7/8"	1-1/16"	HN-2030			20
1-3/8	6 UNC	2-1/16"	1-11/64"				10
1-1/2	6 UNC	2-1/4"	1-9/32"	HN-2032			10

Thickness & Width Across Flats to ANSI/ASME B18.2.2

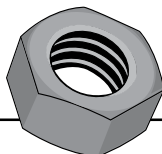

FINISHED JAM HEXAGON NUTS

18-8 Stainless Steel - Plain Finish

SPAENAUR No. UNC COARSE THREAD		SPAENAUR No. UNF FINE THREAD		Width Across Flat	Thickness	PKG QTY.
159-W11-1W	1/4"-20	159-005	1/4"-28	7/16"	5/32"	100
159-W09-1W	5/16"-18	159-007	5/16"-24	1/2"	3/16"	100
159-008	3/8"-16	159-009	3/8"-24	9/16"	7/32"	100
159-W01-1X	7/16"-14	159-W18-1N	7/16"-20	11/16"	1/4"	50
159-003	1/2"-13	159-012	1/2"-20	3/4"	5/16"	50
159-W13-1W	5/8"-11	159-014	5/8"-18	15/16"	3/8"	50
159-015	3/4"-10	159-016	3/4"-16	1-1/8"	27/64"	50
159-017	7/8"-9	159-018	7/8"-14	1-5/16"	31/64"	25
159-W14-1A	1"-8	159-W16-1Y	1"-14	1-1/2"	35/64"	25

CATALOG 14

SPAENAUR

Nylon Hex Nuts / Jam Nuts / Locknuts

Inch

Écrous hexagonaux / Contre-écrous / Écrous freinés en nylon

Pouce

Standard HEX NUTS

for MACHINE SCREWS
& CAP SCREW SIZES

Molded NYLON

ASME B18.6.3

Type 6/6 UL94V2

CORROSION-RESISTANT

They resist vibration.

*Preferred for use on ceramic,
glass or enamel surfaces.*

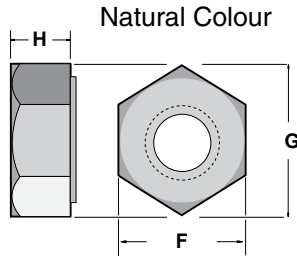

WASHER FACED, SINGLE CHAMFERED AND DOUBLE COUNTERSUNK. Use with plastic or metal screws in assemblies where nylon's many outstanding properties can be used to advantage.

SPAENAUR No.	Thread	Dimensions			PKG QTY.
		F	G	H	
HN-5000	2-56	.180"	.205"	.070"	100
163-002	3-48	.180"	.205"	.070"	100
163-A01-1P	4-40	.250"	.275"	.100"	100
HN-5002	6-32	.305"	.350"	.120"	100
163-003	6-40	.305"	.350"	.120"	100
HN-5003	8-32	.335"	.380"	.130"	100
HN-5004	10-24	.365"	.420"	.135"	100
HN-5005	10-32	.365"	.420"	.135"	100
HN-5006	1/4"-20	.433"	.510"	.235"	100
HN-5007	1/4"-28	.425"	.510"	.200"	100
HN-5012	5/16"-18	.500"	.575"	.270"	100
HN-5008	3/8"-16	.560"	.630"	.330"	100
163-004	7/16"-14	.685"	.780"	.380"	50
163-005	7/16"-20	.685"	.780"	.380"	50
HN-5009	1/2"-13	.750"	.860"	.430"	50
163-008	1/2"-20	.750"	.860"	.430"	50
163-001	5/8"-11	.925"	1.062"	.550"	50
163-010	5/8"-18	.925"	1.05"	.550"	50
163-006	3/4"-10	1.093"	1.260"	.640"	50
163-007	7/8"-9	1.275"	1.469"	.750"	25
163-009	1"-8	1.47"	1.70"	.870"	25

MOLDED 6/6 NYLON

Molded Hex Jam Nuts are used in combination with standard nuts or in pairs for locking action in critical or high vibration areas. *Non-Standard Thread

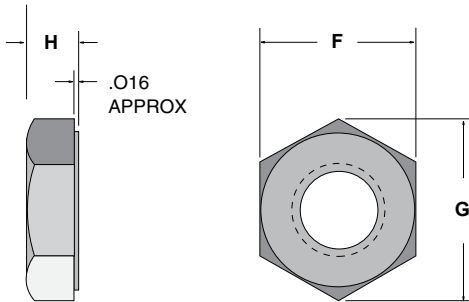

Natural Colour

HEX JAM NUTS

SPAENAUR No.	Thread	Dimensions			PKG QTY.
		F	G	H	
163-050	5/16"-18	.500"	.575"	.190"	100
163-051	5/16"-24	.500"	.575"	.190"	100
163-049	3/8"-16	.500"	.575"	.125"	100
163-052	3/8"-16	.670"	.760"	.219"	100
163-053	3/8"-24	.500"	.575"	.125"	100
163-054	3/8"-32	.500"	.575"	.125"	100
163-055	1/2"-13	.687"	.780"	.220"	50
*163-056	1/2"-24	.687"	.780"	.220"	50
163-057	3/4"-10	1.125"	1.260"	.250"	50
*163-058	3/4"-27	1.000"	1.040"	.125"	50
N.P.T. THREADS					
163-059	1/4"-18	.740"	.850"	.187"	100
163-060	3/8"-18	1.000"	1.150"	.280"	100
163-061	1/2"-14	1.250"	1.430"	.340"	50
163-062	3/4"-14	1.500"	1.730"	.405"	50

Hexagon Locknuts

Designed with washer base to ensure correct placement and positioning of hexagon locknut, while tapered thread provides positive locking action.

MOLDED NYLON

Type 6/6 UL94V2

(Natural Colour)

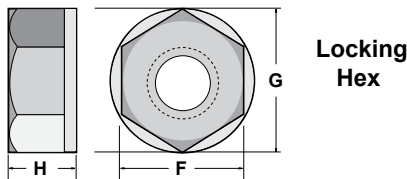

SPAENAUR No.	Thread	Dimensions			PKG QTY.
		F	G	H	
163-100	2-56	.180"	.205"	.140"	100
163-101	4-40	.250"	.275"	.180"	100
163-A02-1Y	6-32	.305"	.350"	.200"	100
163-103	8-32	.335"	.380"	.230"	100
163-104	10-24	.365"	.420"	.250"	100
163-105	10-32	.365"	.420"	.250"	100
163-106	1/4"-20	.425"	.510"	.275"	100
163-107	Same as 163-106 except black				100

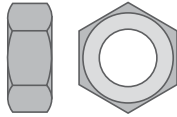

ISO Metric
Property Class 6 **STEEL**

DIN 934

This Standard has been replaced. Please see Catalog Page R21 for more information.

COARSE AND FINE THREADS

STANDARD TYPE

DIA. in mm	Width across Flats mm	Thick- ness in mm	PKG QTY.	PLAIN FINISH				ZINC PLATED				YELLOW ZINC	
				"REGULAR" (Coarse) THREAD		"FINE" THREAD		"REGULAR" (Coarse) THREAD		"FINE" THREAD		"REGULAR" (Coarse) THREAD	
				SPAENAUR No.	Pitch mm	SPAENAUR No.	Pitch mm	SPAENAUR No.	Pitch mm	SPAENAUR No.	Pitch mm	SPAENAUR No.	Pitch mm
M1	2.5	0.8	100					156-001ZP	0.25				
M1.2	3	1	100					156-002ZP	0.25				
M1.6	3.2	1.3	100					156-004ZP	0.35				
M1.7	3.5	1.4	100	156-005	0.35			156-005ZP	0.35				
M1.8	3.5	1.4	100					156-271ZP	0.35				
M2	4	1.6	100	156-006	0.40			156-006ZP	0.40			156-006YZ	0.40
M2.3	4.5	1.8	100					156-007ZP	0.40				
M2.5	5	2	100	156-008	0.45			156-008ZP	0.45			156-008YZ	0.45
M2.6	5	2	100	156-009	0.45			156-009ZP	0.45				
M3	5.5	2.4	100	156-010	0.50			156-010ZP	0.50	156-048ZP	0.35		
M4	7	3.2	100	156-012	0.70			156-012ZP	0.70	156-049ZP	0.50		
M5	8	4	100							156-050ZP	0.50		
M6	10	5	100			156-051	0.75			156-051ZP	0.75		
M10	17	8	100							156-135ZP	1.25		

ISO Metric
Property Class 6
Steel

LEFT HAND THREADS
COARSE AND FINE

DIN 934

This Standard has been replaced. Please see Catalog Page R21 for more information.

STANDARD TYPE

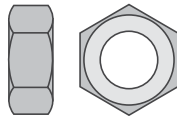

DIA. in mm	Width across Flats mm	Thick- ness in mm	PKG QTY.	PLAIN FINISH	
				"REGULAR" (Coarse) THREAD	
				SPAENAUR No.	Pitch mm
M8L	13	6.5	100	156-223	1.25

ISO Metric
Property Class 8

LEFT HAND THREADS

STEEL
ZINC PLATED

DIN 934

This Standard has been replaced. Please see Catalog Page R21 for more information.

STANDARD TYPE

SIZE DIA. mm	SPAENAUR No.	PITCH mm	WIDTH ACROSS FLATS mm	THICK- NESS mm	PKG QTY.	SIZE DIA. mm	SPAENAUR No.	PITCH mm	WIDTH ACROSS FLATS mm	THICK- NESS mm	PKG QTY.
M3L	156-300	0.50	5.5	2.4	100	M14L	156-307	2.00	22	11	50
M4L	156-301	0.70	7	3.2	100	M16L	156-308	2.00	24	13	50
M5L	156-302	0.80	8	4	100	M18L	156-309	2.50	27	15	25
M6L	156-303	1.00	10	5	100	M20L	156-310	2.50	30	16	25
M8L	156-304	1.25	13	6.5	100	M22L	156-311	2.50	32	18	25
M10L	*156-305	1.50	17	8	100	M24L	156-312	3.00	36	19	25
M12L	156-306	1.75	19	10	100	M30L	156-313	3.50	46	24	25

*160-102 A2 Stainless Steel

See following page for Property Class 8 STANDARD RIGHT HAND THREAD.

Hex Nuts

Metric

Écrous hexagonaux

Métrique

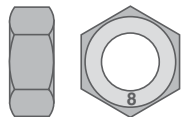

ISO Metric

Property Class 8 Steel

Coarse and Fine Threads

DIN 934 This Standard has been replaced. Please see Catalog Page R21 for more information.

STANDARD TYPE

High tensile HEAT TREATED

Proof Load: **800 N/mm²** (=115,000 PSI.)

DIA. in mm	Width across Flats mm	Thick-ness in mm	PKG QTY.	PLAIN FINISH				ZINC PLATED				YELLOW ZINC						
				"REGULAR" (Coarse) THREAD		"FINE" THREAD		"REGULAR" (Coarse) THREAD		"FINE" THREAD		"REGULAR" (Coarse) THREAD		"FINE" THREAD				
				SPAENAUR No.	Pitch mm	SPAENAUR No.	Pitch mm	SPAENAUR No.	Pitch mm	SPAENAUR No.	Pitch mm	SPAENAUR No.	Pitch mm	SPAENAUR No.	Pitch mm			
M1.8	3.5	1.4	100					156-827ZP	0.35									
M2	4	1.6	100					156-273ZP	0.40									
M2.5	5	2	100	156-274	0.45			156-274ZP	0.45			156-274YZ	0.45					
M3	5.5	2.4	100	156-275	0.50			156-F14-1M	0.50			156-275YZ	0.50					
M3.5	6	2.8	100	156-011	0.60			156-011ZP	0.60			156-011YZ	0.60					
M4	7	3.2	100	156-136	0.70			156-F07-1C	0.70			156-136YZ	0.70					
M5	8	4	100	156-013	0.80			156-013ZP	0.80			156-013YZ	0.80					
M6	10	5	100	156-014	1.00			156-014ZP	1.00			156-014YZ	1.00					
M7	11	5.5	100	156-015	1.00			156-015ZP	1.00			156-015YZ	1.00					
M8	13	6.5	100	156-016	1.25	156-039	1.00	156-016ZP	1.25	156-039ZP	1.00	156-016YZ	1.25	156-039YZ	1.00			
M10	17	8	100	156-017	1.50	156-052	1.25	156-040	1.00	156-017ZP	1.50	156-052ZP	1.25	156-040ZP	1.00	156-017YZ	1.50	
M12	19	10	100	156-018	1.75	156-053	1.25	156-041	1.00	156-F09-1T	1.75	156-053ZP	1.25	156-041ZP	1.00	156-018YZ	1.75	
			100			156-133	1.50					156-133ZP	1.50			156-133YZ	1.50	
M14	22	11	100	156-019	2.00	156-042	1.50			156-019ZP	2.00	156-042ZP	1.50			156-019YZ	2.00	
M16	24	13	100	156-020	2.00	156-043	1.50	156-278	1.00	156-F10-1N	2.00	156-043ZP	1.50			156-020YZ	2.00	156-043YZ
M18	27	15	50	156-021	2.50	156-279	2.00	156-044	1.50	156-021ZP	2.50	156-044ZP	1.50					
M20	30	16	50	156-022	2.50	156-280	2.00	156-045	1.50	156-022ZP	2.50	156-045ZP	1.50			156-022YZ	2.50	
M22	32	18	50	156-023	2.50	156-281	2.00	156-046	1.50	156-023ZP	2.50	156-046ZP	1.50					
M24	36	19	50	156-024	3.00	156-054	2.00	156-047	1.50	156-024ZP	3.00	156-054ZP	2.00	156-047ZP	1.50	156-024YZ	3.00	
M27	41	22	25	156-025	3.00	156-102	2.00	156-282	1.50	156-025ZP	3.00	156-102ZP	2.00					
M30	46	24	25	156-026	3.50	156-103	2.00	156-F06-1M	1.50	156-026ZP	3.50	156-103ZP	2.00			156-026YZ	3.50	
M33	50	26	15	156-027	3.50	156-285	2.00	156-284	1.50	156-027ZP	3.50							
M36	55	29	10	156-028	4.00	156-104	3.00	156-286	1.50	156-028ZP	4.00	156-104ZP	3.00			156-104YZ	3.00	
			10			156-325	2.00											
M39	60	31	10	156-029	4.00	156-287	3.00			156-029ZP	4.00							
M42	65	34	10	156-030	4.50			156-105	3.00	156-030ZP	4.50		156-105ZP	3.00				
M45	70	36	10	156-031	4.50					156-031ZP	4.50							
M48	75	38	10	156-032	5.00			156-106	3.00	156-032ZP	5.00		156-106ZP	3.00				
M52	80	42	10	156-033	5.00					156-033ZP	5.00							
M56	85	45	1	156-295	5.50													
M64	95	51	1	156-289	6.00					156-289ZP	6.00							
M68	100	54	1	156-290	6.00													
M72	105	58	1	156-291	6.00													
M80	115	64	1	156-293	6.00													

See previous page for Property Class 8 Hex Nuts - Left Hand Threads.

ASSORTMENT 805-407

DIN 934, Coarse Thread

Property Classes 5, 8 and 10 Steel Plain and Plated

24 Sizes - 922 Pieces

Furnished in REGULAR SIZE grey enamelled drawer. Drawer will fit into Slide Racks shown on A2

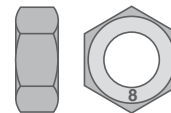

Metric HEXAGON NUTS (Standard)



For the complete assortment contents turn to A61

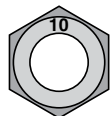
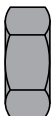

ISO Metric

Property Class 10

Steel

DIN 934 This Standard has been replaced. Please see Catalog Page R21 for more information.

STANDARD TYPE

Proof Load: **1000 N/mm²** (=150,000 PSI.)

DIA. in mm	Width across Flats mm	Thick- ness in mm	PKG QTY.	PLAIN FINISH			ZINC PLATED		YELLOW ZINC			
				"REGULAR" (Coarse) THREAD			"FINE" THREAD		"REGULAR" (Coarse) THREAD	"REGULAR" (Coarse) THREAD		
				SPAENAUR No.	Pitch mm	SPAENAUR No.	Pitch mm	SPAENAUR No.	Pitch mm	SPAENAUR No.	Pitch mm	
M3	5.5	2.4	100	*156-110	0.50				156-110YZ	0.50		
M3.5	6	2.8	100						156-111YZ	0.60		
M4	7	3.2	100	156-112	0.70				156-112YZ	0.70		
M5	8	4	100	156-113	0.80			156-F05-1N	0.80	156-F13-1W	0.80	
M6	10	5	100	156-114	1.00					156-114YZ	1.00	
M7	11	5.5	100	156-237	1.00							
M8	13	6.5	100	156-116	1.25	156-238	1.00		156-116ZP	1.25	156-116YZ	1.25
M10	17	8	100	156-117	1.50	156-239	1.00		156-117ZP	1.50	156-117YZ	1.50
M12	19	10	100	156-118	1.75	156-241	1.25	156-240	1.00		156-118YZ	1.75
	19	10	100			156-242	1.50					
M14	22	11	100	156-119	2.00	156-243	1.50				156-119YZ	2.00
M16	24	13	100	156-120	2.00	156-244	1.50		156-120ZP	2.00	156-120YZ	2.00
M18	27	15	50	156-121	2.50	156-246	2.00	156-245	1.50		156-121YZ	2.50
M20	30	16	50	▲156-122	2.50	156-248	2.00	156-247	1.50		156-122YZ	2.50
M22	32	18	50	156-123	2.50	156-250	2.00	156-249	1.50		156-123YZ	2.50
M24	36	19	50	156-124	3.00	156-358	2.00	156-251	1.50		156-124YZ	3.00
M27	41	22	25	156-125	3.00	156-253	2.00	156-252	1.50		156-125YZ	3.00
M30	46	24	25	156-126	3.50	156-255	2.00	156-254	1.50		156-126YZ	3.50
M33	50	26	10	156-256	3.50	156-258	2.00	156-257	1.50			
M36	55	29	10	156-259	4.00	156-359	3.00	156-260	1.50			
M39	60	31	10	156-262	4.00	156-360	3.00					
M42	65	34	5	156-263	4.50	156-357	3.00					
M45	70	36	5	156-264	4.50	156-265	3.00					
M48	75	38	5	156-267	5.00							
M52	80	42	1	156-266	5.00							

*156-110NP Nickel Plated ▲156-412 Prop. Cl. 12, Plain Finish

For High-strength Washers, see pg. D18. For High-strength Hex Head Bolts, see pg. B170

ASSORTMENT ASSORTIMENT **805-472**

DIN 933 / DIN 931

Metric HEXAGON HEAD CAP SCREWS

Property Class 10.9
Regular COARSE Thread

Medium Carbon Steel, Quenched & Tempered Zinc Plated and Dichromate Dipped (Gold Colour)

24 SIZES — 550 PIECES

Furnished in a regular size grey enamelled steel drawer, with hinged lid and scoop bins. Drawer will fit slide racks shown on page A2

Shipping Weight: **10.4 kg** (23 lbs.)



For the complete assortment contents turn to A51

Hex Nuts

Écrous hexagonaux

Metric

Métrique

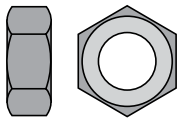

BRASS NYLON STAINLESS STEEL
STANDARD TYPE

▼ This Standard has been replaced. Please see Catalog Page R21 for more information.

DIA. in mm	Width A/F mm	Thick- ness mm	PKG QTY.	Pitch mm	COARSE THREAD DIN 934 ▼				FINE THREAD DIN 934 ▼		
					BRASS	NYLON Polyamid 6/6	STAINLESS STEEL		Pitch mm	STAINLESS STEEL	
							A2	A4		A2	A4
M1	2.5	0.9	25	0.25	158-018		160-001				
M1.2	3	1	25	0.25	158-019		160-002				
M1.4	3	1.2	25	0.30	158-020		160-003				
M1.6	3.5	1.3	100	0.35	158-021		160-004	160-078			
M1.7	3.5	1.4	100	0.35	158-022						
M2	4	1.6	100	0.40	158-001	164-005	160-A08-1P	160-A09-1Y			
M2.3	4.5	1.6	100	0.40			160-006				
M2.5	5	2	100	0.45	158-002	164-007	160-A01-1N	160-080			
M2.6	5	2	100	0.45	158-024		160-008				
M3	5.5	2.4	100	0.50	158-003	164-010	160-A07-1A	160-050			
M3.5	6	2.8	100	0.60	158-004	•164-019	160-009	160-060			
M4	7	3.2	100	0.70	▲158-005	164-011	160-A02-1M	160-A06-1X			
M5	8	4	100	0.80	158-006	164-012	160-012	160-052			
M6	10	5.2	100	1.00	■158-007	164-013	160-013	160-053			
M8	13	6.8	100	1.25	158-R02-1K	164-015	160-014	160-054	1.00	160-064	160-081
M10	14.8	9.8	100	1.50		164-020					
M10	16	8.4	100	1.50	158-010		160-015	160-055	1.00	160-065	160-082
			100						1.25	160-066	160-083
M12	18	10.8	100	1.75	158-011	164-017	160-016	160-056	1.50	160-067	160-084
M14	21	12.8	◆	2.00	158-012		160-017	160-057	1.50	160-048	
M16	24	14.8	◆	2.00	158-013	164-018	160-018	160-A03-1K	1.50	160-068	160-085
M18	27	15.8	◆	2.50			160-019	160-059			
M20	30	18	◆	2.50	158-015	164-N01-1T	160-020	160-061	1.50	160-069	160-086
M22	34	19.4	◆	2.50	158-016		160-021	160-062			
M24	36	21.5	◆	3.00	158-017	164-024	160-022	160-063	1.50	160-049	
M27	41	23.8	◆	3.00				160-087			
M30	46	25.6	◆	3.50	158-027		160-024	160-088			
M33	50	28.7	◆	3.50				160-089			
M36	55	31	◆	4.00			160-071	160-090			
M39	60	33.4	◆	4.00			160-072	160-091			
M42	65	34	◆	4.50			160-073	160-092			
M45	70	36	◆	4.50				160-093			
M48	75	38	◆	5.00				160-094			
M52	80	42	◆	5.00				160-095			

◆ Contact Sales Desk For Package Quantities ▲158-R01-1T Nickel Plated ■158-007NP Nickel Plated ●Delrin

DIN 934

This Standard has been replaced. Please see Catalog Page R21 for more information.

METRIC HEX NUTS

ALUMINUM - Plain Finish

Dia.	Width A/F	Thick- ness	Pitch	SPAENAU No.	PKG QTY.
M6	10	5.2	1.00	162-301	100
M8	13	6.8	1.25	162-300	100
M10	16	8.4	1.50	162-302	100
M12	18	10.8	1.75	162-303	100

All dimensions in millimetres

DIN 70615

HEXAGON NUTS small across flat

METRIC
PROPERTY CLASS 8
STEEL - Plain Finish

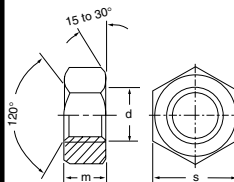

All dimensions in millimetres

Dia.	Width A/F	Thick- ness	Pitch	SPAENAU No.	PKG QTY.
M10	15	8.0	1.00	156-377	100
M10	15	8.0	1.25	156-379	100
M10	15	8.0	1.50	*156-378	100

Items listed below are similar to DIN 70615

M10	14	8.0	1.25	156-381	100
M10	14	8.0	1.50	156-382	100

*156-378ZP Zinc Plated

Metric

Hex Nuts

Métrique

Écrous hexagonaux

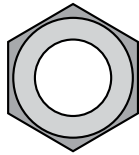

HEXAGON LOW NUTS COARSE THREAD

ISO Metric PROPERTY CLASSES 4 & 5 Steel

(CLASS 5 Steel will be discontinued when present stock expires.)

DIN 439B

**A2 STAINLESS STEEL
and BRASS**

This Standard has been replaced. Please see Catalog Page R21 for more information.

(See page C14 for FINE THREAD)

ORDER BY SPAENAUR NUMBERS LISTED BELOW

DIA. in mm	Width A/F mm	Thick- -ness mm	Pitch in mm	PKG QTY.	Metric CLASS 4			Metric CLASS 5	STAINLESS	BRASS
					PLAIN	ZINC PLATED	NICKEL PLATED	ZINC PLATED	STEEL A2	
M2	4	1.2	0.40	100	156-055	156-055ZP			160-028	158-028
M2.3	4.5	1.2	0.40	100				156-167ZP		158-039
M2.5	5	1.6	0.45	100	156-057	156-F04-1A			160-029	158-029
M2.6	5	1.6	0.45	100		156-058ZP				
M3	5.5	1.8	0.50	100	156-059	156-059ZP	156-059NP		160-030	158-030
M3.5	6	2	0.60	100	156-060	156-060ZP			160-031	
M4	7	2.2	0.70	100	156-061	156-061ZP			160-032	158-031
M5	8	2.7	0.80	100	156-062	156-F12-1K	156-062NP		160-A04-1W	158-032
M6	10	3.2	1.00	100	156-063	156-063ZP	156-063NP		160-034	▲158-033
M7	11	3.5	1.00	100		156-064ZP				
M8	13	4	1.25	100	156-137	156-137ZP			160-035	158-034
M10	16	5	1.50	100	156-140	156-140ZP			■ 160-036	158-035
M12	18	6	1.75	100	156-143	156-143ZP			160-037	158-036
M14	21	7	2.00	100	156-145	156-145ZP			160-038	
M16	24	8	2.00	50	156-146	156-146ZP			160-039	158-037
M18	27	9	2.50	50	156-149					
M20	30	10	2.50	50		156-152ZP			160-040	158-038
M22	34	11	2.50	50	156-196					
M24	36	12	3.00	25	156-155	156-155ZP			160-041	
M30	46	15	3.50	25					160-042	
M33	50	16.5	3.50	10	156-156					
M39	60	19.5	4.00	10	156-159					
M42	65	21	4.50	10	156-158					

SEE NEXT PAGE FOR FINE THREAD SIZES

Additional Finishes or Metric Property Classes of DIN 439B Coarse Thread

- ▲ 158-033NP M6 x 1.00, Brass, Nickel Plated (PKG QTY. 100)
- 160-046 M10 x 1.50, A4 Stainless Steel (PKG QTY. 100)

This Standard has been replaced. Please see Catalog Page R21 for more information.

ASSORTMENT **805-409A**

DIN 439 (Property Class 4),
DIN 936 (Property Class 17H)

**Metric
HEXAGON NUTS
(Low Style)**

Coarse and Fine Thread
Plain and Plated Steel

21 SIZES - 1108 PIECES

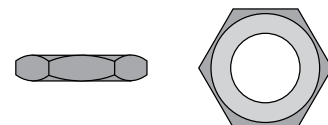

Shipping Weight: **4.676 kg** (10.5 lbs.)



For the complete assortment contents turn to A60

Hex Low Nuts / Thick Nuts

Metric

Écrous hexagonaux bas / hauts

Métrique

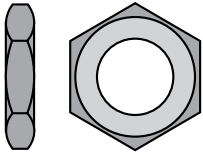

**HEXAGON
LOW NUTS
FINE THREAD**

DIN 439B

This Standard has been replaced. Please see Catalog Page R21 for more information.

ISO Metric

PROPERTY CLASSES 4, 5 & 6 STEEL
(Property Class 5 will be discontinued when present stock expires.)
and A2 STAINLESS STEEL

(See page C13 for COARSE THREAD)

ORDER BY SPAENAUR NUMBERS LISTED BELOW

DIA. in mm	Width A/F mm	Thick- ness mm	Pitch in mm	PKG QTY.	Metric CLASS 4		Metric CLASS 5 PLAIN	STAINLESS STEEL A2	STAINLESS STEEL
					PLAIN	ZINC PLATED			
M8	13	4	1.00	100	156-134	156-134ZP		160-096	
M10	16	5	1.25	100	156-139	156-139ZP		▲160-098	160-103
			1.00	100	156-138	156-138ZP		160-097	
M12	18	6	1.00	100		156-160ZP			
M12	18	6	1.25	100	156-141				
			1.50	100	156-142			160-099	
M14	21	7	1.50	100	156-144				
M16	24	8	1.50	50	156-193			160-100	
M18	27	9	1.50	50	156-147				
M20	30	10	1.50	50	156-150			160-026	
			2.00	50	156-151				
M22	32	11	1.50	50	156-194				
			2.00	50	156-195				
M24	36	12	1.50	25	156-153			160-101	
			2.00	25	156-154				
M30	46	15	1.50	25			156-179		
M33	50	16.5	2.00	10	156-162		156-197		
			1.50	10	156-157				
M42	65	21	1.50	10			156-187		

SEE PAGE C13 FOR COARSE THREAD SIZES

▲160-103 A4 Stainless Steel

HEX THICK NUTS

Metric Coarse Thread

UNI 587

Property Class 6 and 8

Steel, Zinc Plated

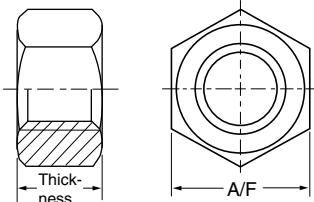

PROPERTY CLASS 6					
SPAENAUR No.	Dia. in mm	Width A/F mm	Thick-ness mm	Pitch in mm	PKG QTY.
156-354	M3	5.5	3	0.5	100
156-355	M4	7	4	0.7	100

PROPERTY CLASS 8					
SPAENAUR No.	Dia. in mm	Width A/F mm	Thick-ness mm	Pitch in mm	PKG QTY.
156-336	M6	10	6	1.0	100
156-337	M8	13	8	1.25	100
156-338	M10	17.16	10	1.5	100
156-339	M12	19.18	12	1.75	100
156-340	M16	24	16	2.0	100
156-341	M20	30	20	2.5	50
156-343	M30	46	30	3.5	25

Metric

Hex Low Nuts

Métrique

Écrous hexagonaux bas

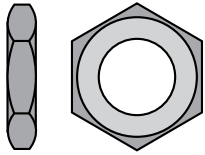

HEXAGON LOW NUTS

COARSE THREAD

DIN 936

ISO Metric PROPERTY CLASSES
17H (04) & 22H (06) STEEL
and A2 STAINLESS STEEL

ORDER BY SPAENAUR NUMBERS LISTED BELOW

DIA. in mm	Width A/F mm	Thick- ness mm	Pitch in mm	PKG QTY.	Metric CLASS 17H (04)		Metric CLASS 22H (06) PLAIN	STAINLESS STEEL A2
					PLAIN	ZINC PLATED		
M8	13	5	1.25	100	156-065	156-F11-1T	156-316	
M10	17	6	1.50	100	156-066	156-066ZP	156-317	160-A05-1M
M12	19	7	1.75	100		156-067ZP	156-335	
M14	22	8	2.00	100	156-068	156-068ZP	156-319	
M16	24	8	2.00	100	156-069	156-069ZP	156-320	
M18	27	9	2.50	50	156-070	156-070ZP	156-321	
M20	30	9	2.50	50	156-071	156-071ZP	156-323	160-802 (PKG.QTY. 25)
M22	32	10	2.50	50	156-072	156-072ZP		
M24	36	10	3.00	50	156-073	156-073ZP		
M27	41	12	3.00	25	156-074	156-074ZP		
M30	46	12	3.50	25	156-075	156-075ZP	156-165	
M33	50	14	3.50	10	156-330		156-199 (PKG.QTY. 25)	
M36	55	14	4.00	10	156-207			
M42	65	16	4.50	10	156-297			

FINE THREAD

DIA. in mm	Width A/F mm	Thick- ness mm	Pitch in mm	PKG QTY.	Metric CLASS 17H (04)		Metric CLASS 22H (06)		METRIC CLASS 05H ZINC PLATED
					PLAIN	ZINC PLATED	PLAIN	ZINC PLATED	
M8	13	5	1.00	100	156-F03-1X		156-090	156-090ZP	
M10	17	6	1.00	100	156-361		156-091	156-091ZP	
M12	19	7	1.50	100	156-038		156-318		
			1.25	100			156-084		
			1.00	100	156-037		156-092	156-092ZP	
M14	22	8	1.50	100	156-085		156-093		
M16	24	8	1.50	100			156-094	156-094ZP	
M18			1.50	50			156-095		156-413ZP
M20	30	9	1.50	50	156-034	156-034ZP	156-324		
			2.00	50			156-096	156-096ZP	
M22	32	10	1.50	50	156-088		156-101	156-101ZP	
			2.00	50			156-097		
M24	36	10	2.00	50	156-089		156-098		
			1.50	50	156-108		156-327		
M27	41	12	2.00	25	156-115			156-107ZP	
			1.50	25	156-109				
M30	46	12	2.00	25	156-200		156-099	156-099ZP	
			1.50	25	156-201		156-329YZ Yellow Zinc		
M33	50	14	1.50	10			156-331		
M36	55	14	2.00	10	156-269				
			1.50	10	156-268		156-333		
M42	65	16	1.50	10	156-298		156-841		

▲156-361YZ Yellow Zinc