

Inch and Metric  
Pouce et Métrique



Pliers / Prying Tools / Extractors  
Pinces / Leviers / Extracteurs

### Grip Pliers

Especially designed for holding larger objects.  
With enlarged quick release lever, like 990-781.

Jaws Chrome-Vanadium, Drop-Forged.



SPAENAUR No.	HAZET No.	L		sb	t <sub>1</sub>	t <sub>2</sub>
		mm	Inch			
990-785	758-2	280	11"	90	170	75

### Piston Ring Compressor

For water cooled and air-cooled engines.

Adjustable within a piston Ø range of 70-100 mm.

Releasable Strap (32 mm)



SPAENAUR No.	HAZET No.	Ø	L
990-882	794U-3	70-100	302-332

### Lever for Removing Door Panels

With trinamic®-handle (protected by design patent) Black plastic material.

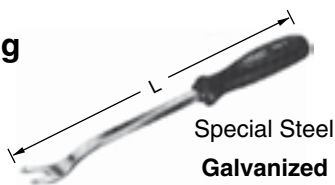

For dismantling of door panels with clips.

SPAENAUR No.	HAZET No.	mm	L	
			mm	Inch
990-895	799-3	28	268	10-1/2"

### Hose Clamp Pliers

For self-gripping spring head clips. Swivel acting jaws, adjustable opening for differently sized clamps. With locking device. Especially for VW-Audi.

Chrome-Vanadium  
Chrome-Plated



SPAENAUR No.	HAZET No.	sb	L	
			mm	Inch
990-893	798-10	90	320	12-1/2"

### Internal Extractors

Special Steel

To be used with Counter Stays.  
SPAENAUR No. 990-863.

SPAENAUR No.	HAZET No.	Ø
877-1415	—	5-8
877-1416	—	6-10
877-1296	—	8-12
877-1263	—	10-14
877-1297	—	12-16
990-855	788-18	14-19
877-1298	—	14-19
990-856	788-23	18-23
877-1299	—	18-23
877-1301	—	28-40
990-859	788-46	36-46
877-1302	—	36-46
990-860	788-56	45-58
877-1303	—	45-58
877-1304	—	56-70



Zinc Plated or Black Finish our option.



Galvanized

### Counter Stays

Special Steel

To be used with above Internal Extractors.

With removable threaded reduction collar.

Galvanized

Application: 990-856: with reduction collar.  
990-859: without reduction collar.



SPAENAUR No.	HAZET No.	Image
877-1305	—	877-1296 877-1296/877-1301 and 877-1415 to 877-1416
877-1306	—	877-1301 to 877-1304 990-856
990-863	788-4670	

### Slide Hammer



Steel - Grey

877-1307 Use with above Internal Extractors with bore diameters of 5-8 mm to 14-19 mm.  
877-1328 Use with diameters of 18-23 mm to 56-70 mm.

CATALOG 14 SPAENAUR

**Pullers / Separators / Extensions**

**Extracteurs / Décolleurs / Rallonges**



Metric

Métrique

**Pulling Devices and Separators**

Special Steel

For removing tightly seated ball-bearings, roller-bearings, innerraces, annular gears, etc.

**Pulling Devices**

To be connected with separators by screwing the stud end into the tap holes in the separator blades.

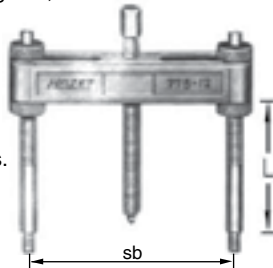

Galvanized

SPAENAUR No.	HAZET No.	sb mm	L mm
877-1274	—	50-110	150
877-1275	—	65-160	200
877-1276	—	60-200	250

**Pitman Arm Shaft Pullers**

Special Steel

Also for ball bearings, gears and similar parts. Screw clamp forces puller hooks securely upon part to be removed.

Galvanized

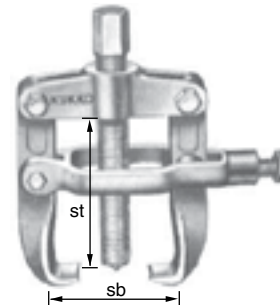

SPAENAUR No.	HAZET No.	sb mm	st mm
877-1281	—	80	90
877-1282	—	100	100
877-1283	—	150	140

**Separators**

Special Steel

Sharp separator edges to be forced behind part to be pulled off.

Separator blades to be compressed by evenly tightening nuts on side bolts.

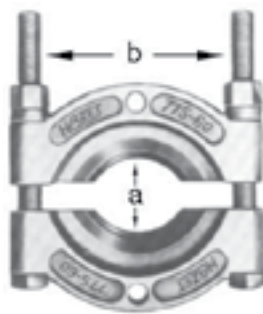

Galvanized



\* With Centre Thrust Screw

SPAENAUR No.	HAZET No.	a mm	b mm
990-819	775-60	5-60	60
877-1265	—	5-60	60
877-1277	—	12-75	75
*877-1279	—	12-75	75
990-820	775-75	12-75	77.5
990-821	775-115	22-115	115
877-1278	—	22-115	115
*877-1280	—	22-115	115

**Ball Joint Pullers**

Special Steel.

For removing the ball pivots when dismantling the ball joints.

Galvanized



SPAENAUR No.	HAZET No.	a mm	b mm	c mm
990-828	779-18	18	36.5	38
990-G05-1A	1779-27	29	61.5	63
■ 990-831	779-39	39	62	78

■ Non-Stock

**Extensions (per pair)**

Special Steel

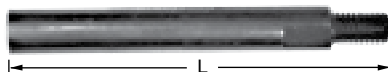

To be used in pairs for extending the length of the puller studs.

Galvanized

SPAENAUR No.	HAZET No.	Diagram	L mm
990-822	775-012		100
990-823	775-021		100

For pulling parts from shafts, screw the studs of suitable puller into two tap holes in separator. Pull away by tightening screw spindle against shaft end.



N

Metric  
Métrique



Pullers / Accessories  
Extracteurs / Accessoires

### Pullers

Special Steel  
Galvanized

For gears, ball bearings, etc.  
Two double-hook arms, each with  
a narrow end for use in  
congested areas.

With 2 arms

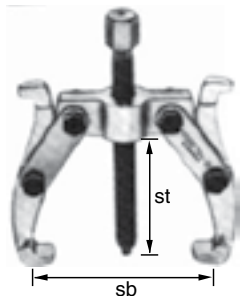

SPAENAUR No.	HAZET No.	sb mm	st mm
877-1284	—	150	85
877-1285	—	220	130

With 3 arms

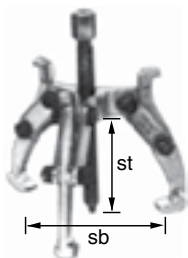

877-1286	—	150	85
877-1287	—	220	130

### Universal Ball Joint Puller

Special steel, Galvanized

For removing the ball pivots when dismantling the ball joints  
on Ford, BMW, Volvo, Toyota, Opel, VW, Audi, Renault,  
Nissan, Fiat and Mercedes-Benz cars

Clamping range, Two stages

Stage 1 = to **30 mm**

Stage 2 = to **50 mm**



PKG QTY. 1

SPAENAUR No.	HAZET No.	Jaw Capacity	a
993-895	779-1	50 mm	20-22 mm

### Two Arm Pullers

Galvanized

Special Steel

SPAENAUR No.	HAZET No.	sb mm	st mm
990-G06-1P	1787F-9	80	100
877-1289	—	80	100
990-840	787 N-12	120	100
990-841	787 N-16	160	150
877-1291	—	160	150
990-842	787 N-20	200	150
877-1292	—	200	150
990-843	787 N-25	250	200
990-G07-1Y	787 N-35	350	200
990-G01-1K	1787-52	520	200
877-1295	—	520	200

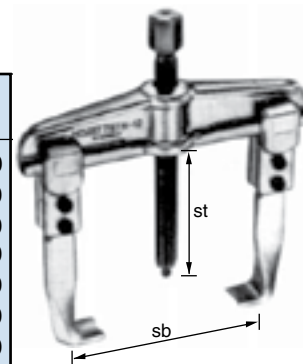

The pulling arms are  
replaceable and can be  
adjusted for inside  
and outside pulling.

### Pulling Arm (per pair)

Galvanized

Special Steel

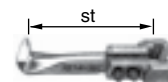

With normal slide jaws

SPAENAUR No.	HAZET No.	st mm	
877-1310	—	100	877-1289
877-1311	—	150	877-1291/877-1292
877-1267	—	200	877-1295

With Extra Long Slide Jaws

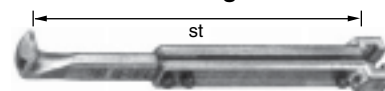

877-1312	—	200	877-1289
877-1266	—	250	877-1289
877-1268	—	300	877-1291/877-1292
877-1269	—	300	877-1295
877-1270	—	400	877-1295
877-1271	—	500	877-1295

### Replacement Forcing Screw

For 2 arm puller.

Steel

SPAENAUR No.	Used With Pulling Device
877-1273	877-1284, 877-1286, 877-1289, 990-G06-1P and 990-840
877-1264	877-1285, 877-1287, 877-1291, 877-1292 and 990-842

**Stud Extractors / Nut Splitters / Blunt Scraper**

Extracteurs de goujons / Casse-écrous / Grattoir à bord abattu



Metric  
Métrique

**Stud Extractors**

1/2 inch

Chrome-Vanadium

Chrome-Plated Polished

For tightening and removing studs and staybolts with r.h and l.h. threads.

With 1/2" inside square drive and 21 mm outside 6 point square drive.



SPAENAUR No.	HAZET No.	ø mm	L mm	D mm	mm
991-131	844-6	6	65	23.5	21
991-132	844-8	8	65	23.5	21
991-133	844-10	10	75	27.0	21
991-134	844-12	12	75	27.0	21

**Stud Extractor**

Special Steel Galvanized

Large gripping range due to low arrangement of eccentric knurled screw, clamps even short stud ends, for tightening and removing studs and staybolts with r.h. and l.h. threads.

SPAENAUR No.	HAZET No.	ø mm
877-1309	—	5-19



**Hydraulic Nut Splitters**

Aluminum colour

Special Steel

For removing unbreakable nuts in the quality range 5, 6, 8 and 10.

Double offset configuration permits use even in congested areas. Low effort due to hydraulic system

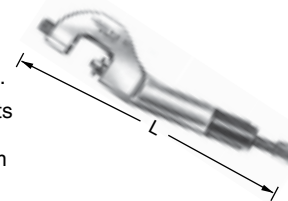

SPAENAUR No.	HAZET No.	mm	L mm
991-138	846-36	22-36	335

**Mechanical Nut Splitter**

Chrome-Vanadium

For removing unbreakable nuts in the quality range 5, 6 and 8. With double splitting effect due to 2 chisels -also for bigger nuts-

Galvanized



SPAENAUR No.	HAZET No.	mm	L mm
991-B01-1A	847-1027A	10-27	132

**Blunt Scraper**

With black plastic handle. With replaceable hard-metal tip, to be used on both sides.



SPAENAUR No.	HAZET No.	mm	L <sub>1</sub> mm	L <sub>2</sub> mm
990-979	825-25	25	267	397

**Replaceable Hard-metal Tips**

990-980	825-025	25	25	—
---------	---------	----	----	---

**Blunt Scraper**

Special Steel Galvanized

Square blade.

For the easy and complete removal of seal remnants.

Handle made of black plastic material.

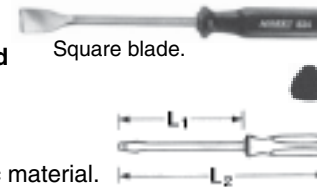

SPAENAUR No.	HAZET No.	mm	L <sub>1</sub> mm	L <sub>2</sub> mm
990-975	824	23	150	270

N