

Spot Weld Screws

Vis à souder par points

STANLEY
Engineered Fastening

GRIPCO

Inch
Pouce

B

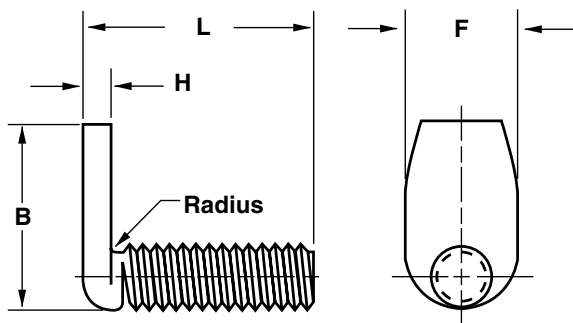

**SPOT WELD SCREWS
"LJ" SERIES**

The LJ Series, Spot Weld Screws are manufactured from low carbon, high welding quality steel. These spot weld screws are designed with a 90° plain spade head for spot welding. This feature allows for welding to or through metal surfaces. The product can be used in confined areas such as narrow channels, walled corners, and in those applications requiring threads offset from component surfaces.

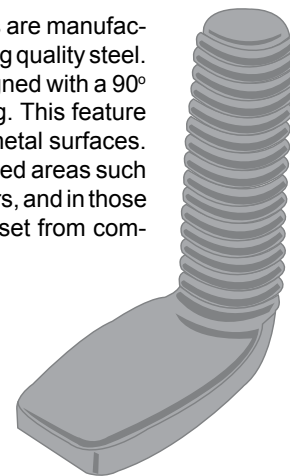

Not Plated

PKG QTY. 100

Can be manufactured to meet specific requirements in production run. Prices available upon request.

Size	#10	#10	1/4"	5/16"	3/8"
Head Width (F)	.312"	.343"	.375"	.437"	.531"
Head Thickness (H)	.062"	.062"	.094"	.125"	.156"
Head Length (B)	.687"	.687"	.750"	.875"	1.000"
Threads Per Inch	24	32	20	18	16
Overall Length (L)	ORDER BY SPAENAUR NUMBERS LISTED BELOW Available size range of LJ Spot Weld Screws.				
1/2"	573-B01-2N				
3/4"	573-128				
1"		573-117			
1-1/4"			573-129		
1-1/2"					573-116
2"				573-121	

Typical weld settings for use with C-1010 steel only. Thickness range of steel sheets, 24 gauge to 6 gauge. Steel sheets must be free from scale, rust and dirt and be uncoated.

SIZE	WELD TIME IN CYCLES	WELD PRESSURE IN POUNDS	WELD CURRENT IN AMPS
#10	5 to 10	400 to 800	9,000 to 15,000
1/4"	6 to 12	500 to 900	12,000 to 18,000
5/16"	8 to 14	800 to 14,000	14,000 to 20,000
3/8"	10 to 25	1,000 to 2,000	15,000 to 24,000

For Spot Weld Pins see Page B133

Inch and Metric
Pouce et Métrique

STANLEY **GRIPCO**
Engineered Fastening

Projection Weld Screws
Vis à souder par bossage

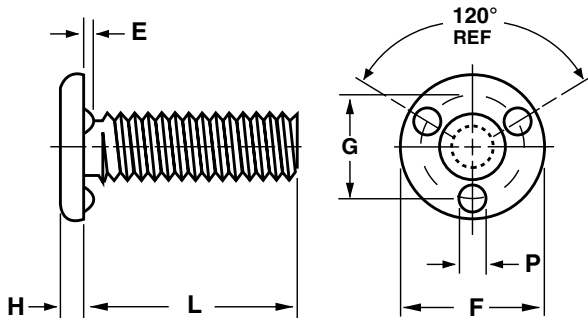

PROJECTION WELD SCREWS "MN" SERIES

The MN Series, Projection Weld Screws are manufactured from low carbon, high welding quality steel. These projection weld screws are designed with 3 weld projections under the head. This feature allows for flush mounting in through-hole applications.

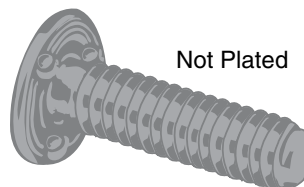

PKG QTY. 100

Size	#10	1/4"	5/16"	3/8"
Head Diameter (F)	.437"	.562"	.750"	.875"
Head Thickness (H)	.062"	.078"	.094"	.109"
Projection Height (E)	.028"	.038"	.043"	.048"
Projection Width (P)	.086"	.104"	.119"	.133"
Locating Circle (G)	.312"	.406"	.531"	.625"
Threads Per Inch	32	20	18	16
Length Under Head (L)	ORDER BY SPAENAUR NUMBERS LISTED BELOW Available size range of MN Projection Weld Screws.			
1/2"		■ 573-020		
3/4"		573-130		
7/8"				◆ 573-009
1"	◆ 573-016		573-015	
1-1/4"	◆ 573-063	573-B02-1T	◆ 573-022	
1-1/2"				573-025
2"			573-043	

■ 573-801 Stainless Steel (Not Stanley Engineered Fastening)

◆ Not Stanley Engineered Fastening

Typical weld settings for use with C-1010 steel only. Thickness range of steel sheets, 24 gauge to 6 gauge. Steel sheets must be free from scale, rust and dirt and be uncoated.

Weld Cycle Time - Cycle = 1/60th of a second

SIZE	WELD TIME IN CYCLES	WELD PRESSURE IN POUNDS	WELD CURRENT IN AMPS
#10	3 to 8	400 to 900	6,000 to 14,000
1/4"	3 to 12	600 to 1,000	10,000 to 15,000
5/16"	4 to 16	700 to 1,100	12,000 to 18,000
3/8"	6 to 18	800 to 1,200	13,000 to 20,000

PROJECTION WELD SCREW "MNM" METRIC SERIES

SPAENAUR No.	Nom. Size x Pitch x Length
573-300	M6 x 1 x 20 mm

E = 1.07-0.97 mm	H = 2.03-1.77 mm
F = 14.3-13.7 mm	P = 2.67-2.41 mm
G = 10.3 mm	See illustration top left.

CATALOG 14

SPAENAUR

Projection Weld Screws

Vis à souder par bossage

STANLEY
Engineered Fastening

GRIPCO

Inch
Pouce

B

**PROJECTION WELD
SCREWS "UN" SERIES**

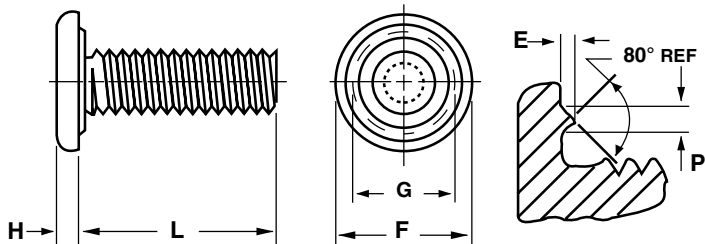

The UN Series, Projection Weld Screws are manufactured from low carbon, high welding quality steel. These projection weld screws are designed with a continuous weld ring projection under the head. This feature allows for flush mounting in hermetically sealed applications.

PKG QTY. 100

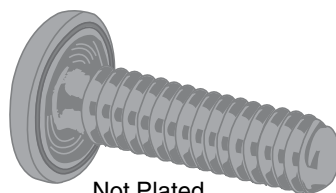

Not Plated

Size	1/4"	3/8"
Head Diameter (F)	.562"	.875"
Head Thickness (H)	.078"	.109"
Projection Height (E)	.025"	.034"
Projection Width (P)	.049"	.067"
Locating Circle (G)	.422"	.641"
Threads Per Inch	20	16
Length Under Head (L)	ORDER BY SPAENAUR No. LISTED BELOW	
5/8"	573-053	
1-1/4"		573-062

Typical weld settings for use with C-1010 steel only. Thickness range of steel sheets, 24 gauge to 6 gauge. Steel sheets must be free from scale, rust and dirt and be uncoated.

SIZE	WELD TIME IN CYCLES	WELD PRESSURE IN POUNDS	WELD CURRENT IN AMPS
#6	3 to 8	300 to 900	9,000 to 18,000
#8	4 to 9	400 to 1,000	10,000 to 19,000
#10	5 to 10	700 to 1,000	13,000 to 20,000
1/4"	5 to 14	900 to 1,500	18,000 to 24,000
5/16"	8 to 19	1,200 to 2,000	22,000 to 42,000
3/8"	10 to 24	1,500 to 2,500	28,000 to 50,000

Weld Cycle Time - Cycle = 1/60th of a second.

Inch
Pouce

STANLEY
Engineered Fastening

GRIPCO

Projection Weld Screws

Vis à souder par bossage

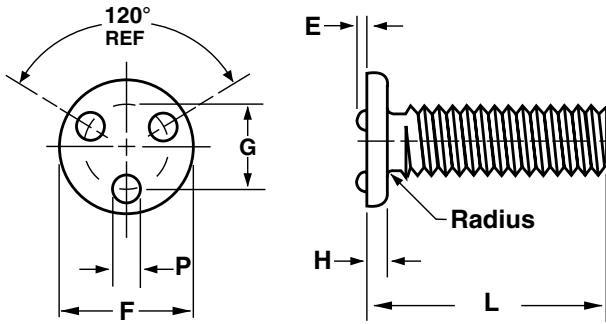

PROJECTION WELD SCREWS "GW" SERIES

The GW Series, Projection Weld Screws are manufactured from low carbon, high welding quality steel. These projection weld screws are designed with 3 weld projections on top of the head. This feature eliminates the need for prepared holes and is ideal in those applications where product appearance is a prime consideration.

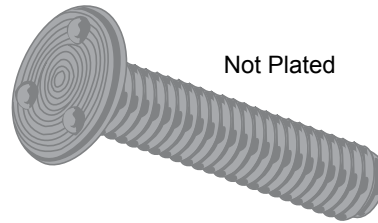

PKG QTY. 100

Size	#6	#8	#10	1/4"	5/16"	3/8"				
Head Diameter (F)	.250"	.312"	.375"	.500"	.625"	.750"				
Head Thickness (H)	.031"	.047"	.062"	.078"	.094"	.109"				
Projection Height (E)	.020"	.024"	.024"	.038"	.043"	.048"				
Projection Width (P)	.058"	.060"	.082"	.104"	.119"	.133"				
Locating Circle (G)	.152"	.203"	.234"	.312"	.391"	.484"				
Threads Per Inch	32	32	24	32	20	28	18	24	16	24

Total Length (L)	ORDER BY SPAENAUR No'S LISTED BELOW									
3/8"	573-058									
1/2"	573-059			573-047						
3/4"					573-048					
7/8"	573-034									
1"									573-060	
2"					573-046					

For Weld Nuts see Pages C43-C47