

Inch

Compartment Latch & Locks / Carriage Keys

Pouce

Loquet de compartiment et serrures / clés de chariot



Compartment Latch
-with Spoon Handle
Mfr. #5669

(Right Illustrated)



For 5/16" square shank

Zinc Plated	099-039 Right	099-042 Left
304 Stainless Steel, Plain Fin.	099-801 Right	099-802 Left

Dimensions:
 3-3/8" length of case
 2" width of case
 5/8" thickness of case
 3/4" edge of door to centre of sq. hole (5/16")
 4-3/4" handle length from centre of sq. hole (5/16")
 17/64" mounting hole diameter - 4 holes
 17/64" x 1/2" mounting slot - 2 slots
 Shipping Weight **.226 kg** (1/2 lb.)
 Stainless Steel Spring
 Durable Metal Bolt and Tumbler

WARNING
This product must not be used for personal restraint applications.

PKG QTY. 1

Compartment Latch
Large Version

Mfr. # 56A

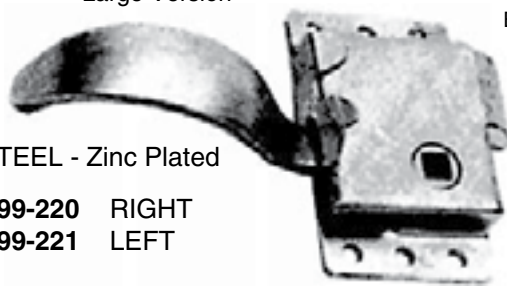

Bolt extends approx. 1/2" from case.

For 5/16" square shank

STEEL - Zinc Plated

099-220 RIGHT
099-221 LEFT

-with Spoon Handle and Inside Locking Feature (Right Illustrated)

Dimensions:
 4-3/8" length of case
 2-3/8" width of case
 11/16" thickness of case
 3/4" edge of door to centre of sq. hole (5/16")
 3-3/4" handle extends from case
 1/4" mounting hole diameter - 4 holes
 1 lb. weight (each)

WARNING
This product must not be used for personal restraint applications.

PKG QTY. 1



New Style Compartment Lock

Especially designed for tool compartment on utility trucks and tank-truck lockers.

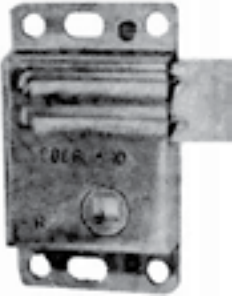

5/16" sq. hole
Mfr. #5667

D-3198R RIGHT
D-3198L LEFT
(Right Illustrated)

Dimensions:
 3-3/8" length of case
 2" width of case
 5/8" thickness of case
 3/4" edge of door to centre of sq. hole
 5/16" square hole for handle
 17/64" mounting hole diameter - 4 holes
 17/64" x 1/2" mounting slot - 2 slots
 6-3/4 oz. weight (each)
 Stainless Steel Spring
 Durable Metal Bolt and Tumbler
 Finish - Plain Steel or Zinc Plated, our option.

PKG QTY. 1

Cab Lock

D-3215-L LEFT
D-3216-R RIGHT

Mfr. #57

CAB LOCK (left-hand), with inside handle. Compact, sturdy, simple. This lock is widely used for application to doors in limited space. Size: 2" wide, 3-3/8" long, 3/4" striker bolt. Can be applied to door frame 2" wide. No mortising or blocking. Die-formed bushing. Weight - 1/2 lbs.

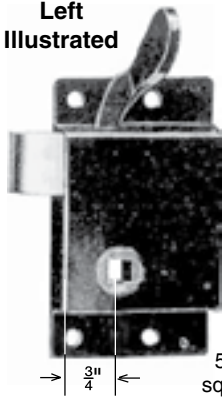

Left Illustrated

3/4" sq. hole

Zinc Plated

PKG QTY. 1

Carriage Keys

Shaped to suit the standard 5/16" square follow bush, these carriage keys are available in choice of three lengths.

Combined with suitable latches, these keys provide a cheap, simple way to secure compartments of every description.

SPAENAUR No. 099-B20-2A
3.5" length

SPAENAUR No. 099-B21-1P
5.0" length

Material - Malleable Iron



PKG QTY. 1

CATALOG 14 SPAENAUR

Inch

Pouce



Compartment Latch with Striker

Loquet de compartiment avec gâche

COMPARTMENT LATCH WITH STRIKER

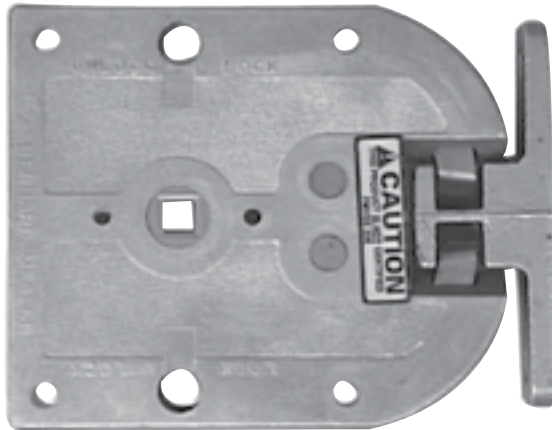

SPAENAUR No.

099-242

(Mfr. #3-206XU)

PKG QTY. 1

Compartment latch mechanism has been designed specifically to fit compartment applications where durability and smooth functional performance are required.

Latch can be surface-mounted on the inside of door panel or between outer and inner door skins. The enclosed strike area mechanism protects against damage by foreign objects.

099-242 can be used in conjunction with any of our handles which have a 5/16" square shank.

Material: Latch - Zinc Die-cast
Striker - Manganese Bronze

CAUTION
This Product is not Certified
FMVSS 206

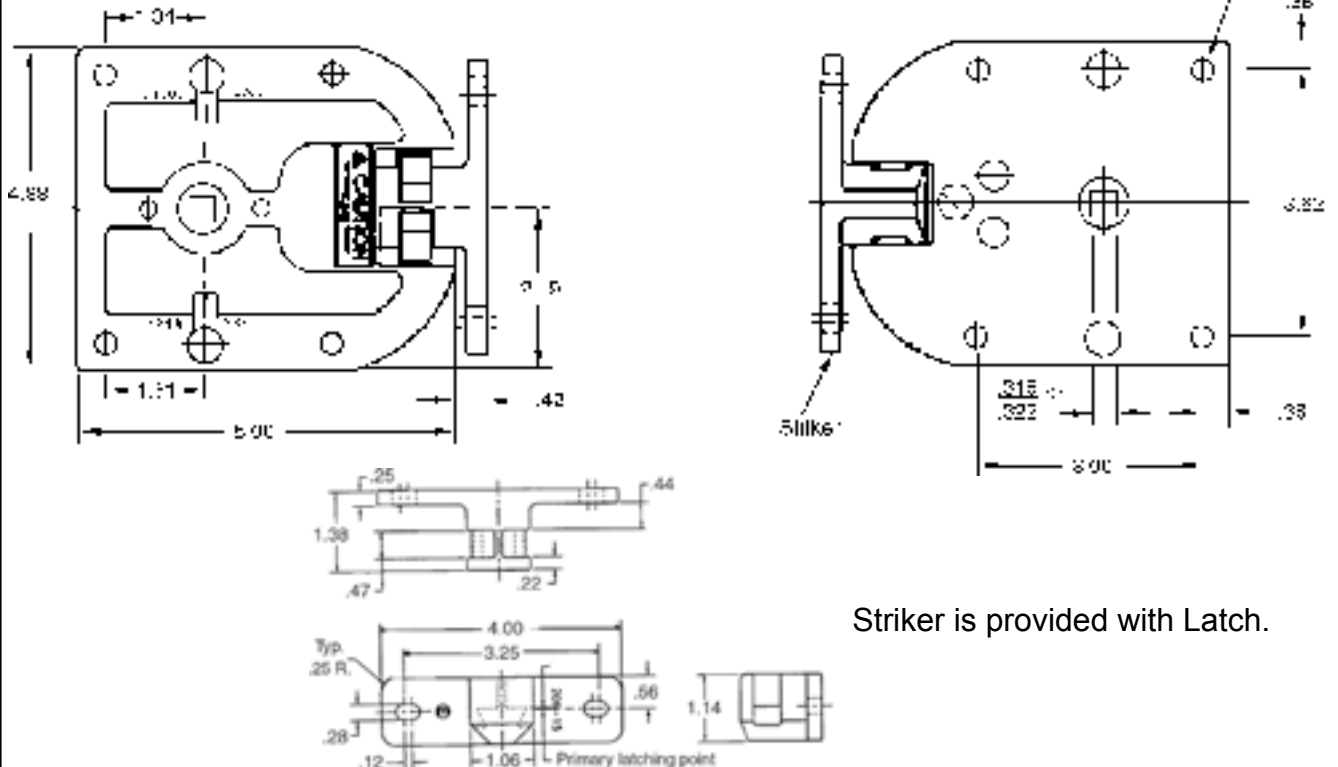

Striker is provided with Latch.

CATALOG 14

SPAENAUR