

**Extruded Channels**

Inch

**Profils extrudés**

Pouce

**Material:** EPDM, Santoprene®, SBR, Neoprene, PVC, Vinyl, etc., as indicated.

*(Please refer to "Elastomer Compound Characteristics" — page R19.)*

**Hardness:** Durometer shown under profile and No., subject to ±5.

**Colour:** Black.

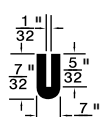
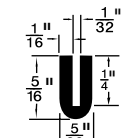
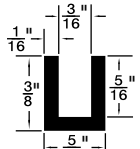
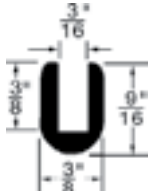
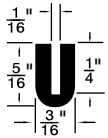
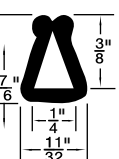
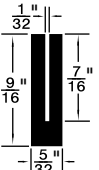
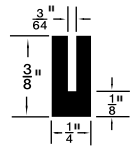
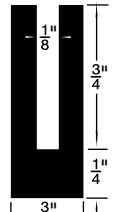
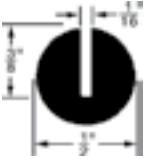
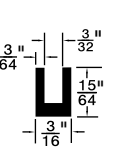
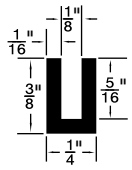
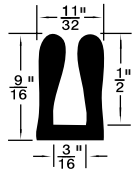
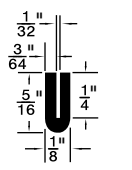
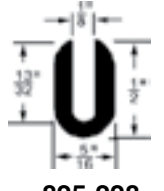
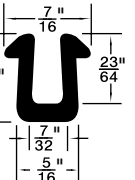
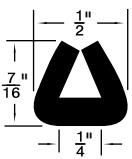
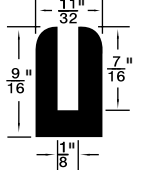
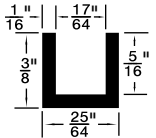
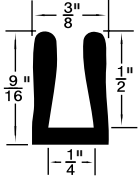
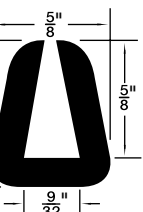
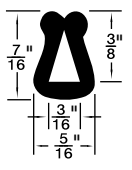
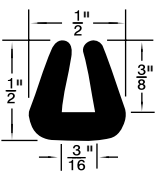
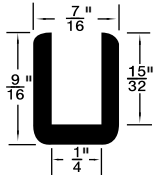
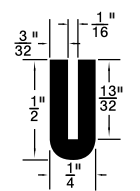
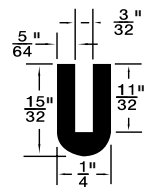
 <p><b>825-B19-1W</b> EPDM Duro 70 PKG QTY. 100</p>	 <p><b>825-B28-1N</b> EPDM Duro 70 PKG QTY. 100</p>	 <p><b>4511-A</b> EPDM Duro 70 PKG QTY. 50</p>	 <p><b>825-229</b> EPDM Duro 50 PKG QTY. 50</p>	 <p><b>825-B13-2P</b> EPDM Duro 65-75 <b>825-B07-1A</b> Neoprene Duro 70 PKG QTY. 50</p>
 <p><b>4517</b> SBR Duro 50 PKG QTY. 50</p>	 <p><b>RW-45</b> SBR Duro 65 PKG QTY. 200</p>	 <p><b>825-B39-1C</b> SBR Duro 70 PKG QTY. 100</p>	 <p><b>825-042</b> Neoprene Duro 60 PKG QTY. 50</p>	 <p><b>825-227</b> Neoprene Duro 60 PKG QTY. 50</p>
 <p><b>825-B36-1A</b> SBR Duro 70 PKG QTY. 100</p>	 <p><b>825-B14-1Y</b> SBR Duro 70 PKG QTY. 50</p>	 <p><b>4514</b> SBR Duro 70 PKG QTY. 50</p>	 <p><b>RW-102</b> SBR Duro 70 PKG QTY. 100</p>	 <p><b>825-228</b> Neoprene Duro 55 PKG QTY. 50</p>
 <p><b>RW-40</b> SBR Duro 70 PKG QTY. 100</p>	 <p><b>825-B38-1Y</b> SBR Duro 70 PKG QTY. 50</p>	 <p><b>RW-35</b> SBR Duro 70 PKG QTY. 50</p>	 <p><b>RW-44</b> SBR Duro 70 PKG QTY. 100</p>	 <p><b>825-B22-1M</b> Santoprene® Duro 70 PKG QTY. 50</p>
 <p><b>C-19</b> SBR Duro 70 PKG QTY. 4 Lengths (11'-6")</p>	 <p><b>4516</b> SBR Duro 70 PKG QTY. 50</p>	 <p><b>825-B05-1N</b> SBR Duro 70 PKG QTY. 50</p>	 <p><b>4588</b> SBR Duro 70 PKG QTY. 50</p>	 <p><b>825-B06-2X</b> Santoprene® Duro 70 PKG QTY. 100</p>
				 <p><b>825-B20-1K</b> Santoprene® Duro 70 PKG QTY. 100</p>

Continued on Next Page

Inch

**Extruded Channels & Weatherstrips**

Pouce

**Profilés et bourrelets d'étanchéité extrudés**

...Continued from previous page.

Colour: Black, unless otherwise indicated.

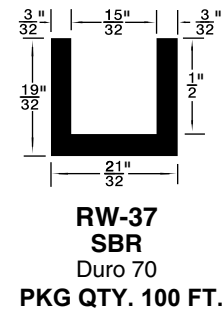
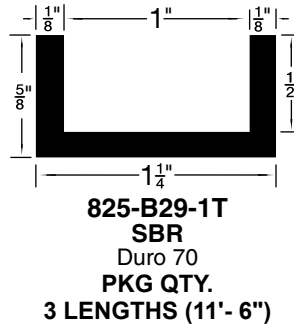
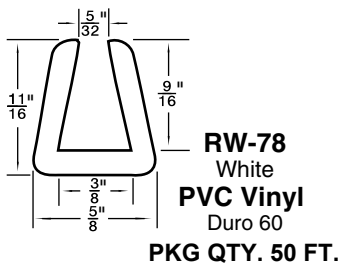
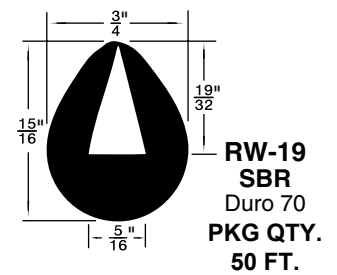
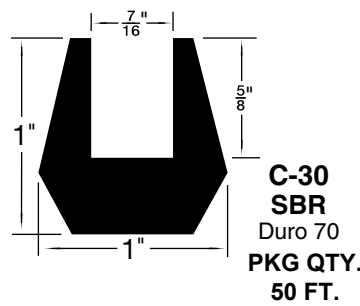
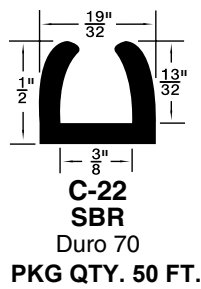
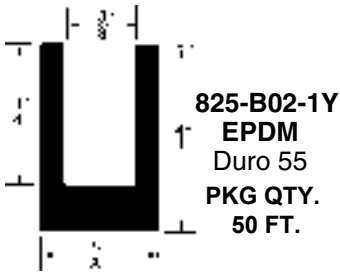

**ONE PIECE SELF-SEALING WEATHERSTRIPS**

Material: EPDM, or SBR as indicated.

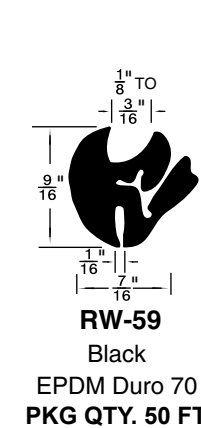
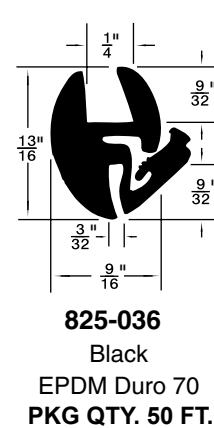
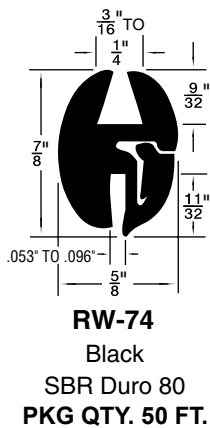
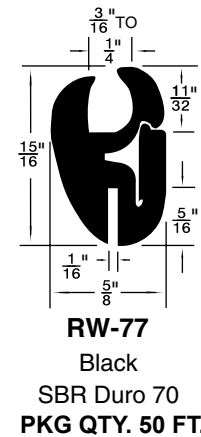
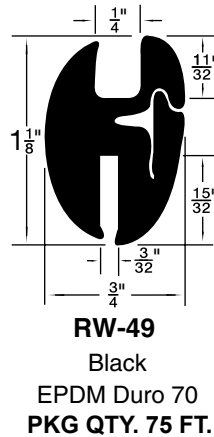
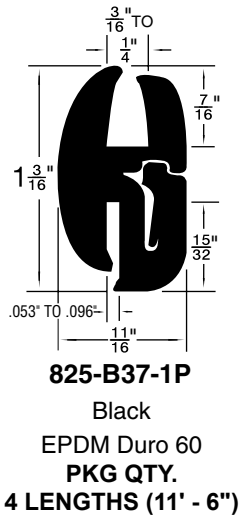

CATALOG 14 SPAENAUR

See section 'R19' for Compound Selection Guide

K

**Two Piece Weatherstrips / Channel**

Inch



**Bourrelets d'étanchéité / profilés deux pièces**

Pouce

**TWO PIECE SELF-SEALING WEATHERSTRIPS**

See "Elastomer Compound characteristics" - page R19.

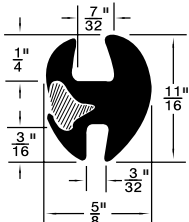
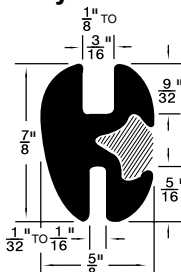
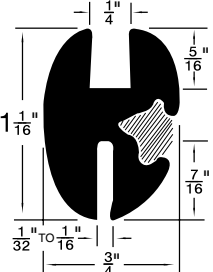
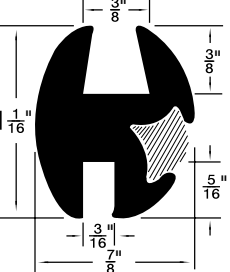
**Channel & Wedge Assembly**

 <p><b>825-039</b> Black - EPDM Duro 70 PKG QTY. 100'</p>	 <p><b>C-37</b> Black - SBR Duro 70 PKG QTY. 50'</p>	 <p><b>B-900</b> Black - EPDM Duro 70 PKG QTY. 75'</p>	 <p><b>RW-92</b> Black - SBR Duro 70 PKG QTY. 4 Lengths (11' - 6")</p>	 <p><b>RW-90G</b> Grey No longer available</p>
--	---	---	--	---



**Channel Only (for above)**

<p><b>825-035</b> Black - SBR Duro 70 PKG QTY. 100'</p>	<p><b>825-283</b> Black - SBR Duro 70 PKG QTY. 50'</p>	<p><b>825-286</b> Black - EPDM Duro 70 PKG QTY. 75'</p>	<p><b>825-294</b> Black - SBR Duro 70 PKG QTY. 4 Lengths (11' - 6")</p>	<p><b>825-289</b> Black No longer available</p>
---	--	---	---	---

**Wedge Only (for above)**

 <p><b>C-36W</b> Black - SBR Duro 80 PKG QTY. 50'</p>	 <p><b>C-37W</b> Black Santoprene® Duro 70 PKG QTY. 50'</p>	 <p><b>B-900W</b> Black - EPDM Duro 80 PKG QTY. 75'</p> <p><b>825-012</b> Chrome - Vinyl Duro 80 PKG QTY. 200'</p>	 <p><b>B-900W</b> Black - EPDM Duro 80 PKG QTY. 75'</p> <p><b>825-012</b> Chrome - Vinyl Duro 80 PKG QTY. 200'</p>	 <p><b>RW-90GW</b> Grey No longer available</p> <p><b>825-012</b> Chrome - Vinyl Duro 80 PKG QTY. 200'</p>
--	--	---	---	---

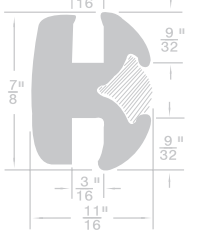
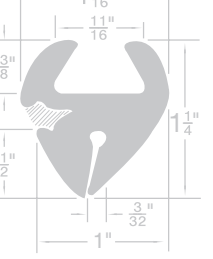
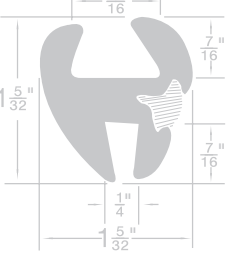

**Channel & Wedge Assembly**

 <p><b>RW-91G</b> Grey No longer available</p>	 <p><b>825-041</b> Black No longer available</p>	 <p><b>825-040</b> Black No longer available</p>	 <p><b>RW-28</b> Black No longer available</p>
---	---	--	---

**Channel Only (for above)**

<p><b>825-292</b> Black - SBR Duro 75 PKG QTY. 50'</p>	<p><b>825-038</b> Black No longer available</p>	<p><b>825-037</b> Black No longer available</p>	<p><b>825-298</b> Black No longer available</p>
--	---	---	---

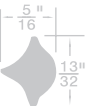
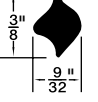
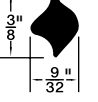
**Wedge Only (for above)**

 <p><b>RW-90GW</b> Grey No longer available</p> <p><b>825-012</b> Chrome - Vinyl Duro 80 PKG QTY. 200'</p>	 <p><b>C-37W</b> Black Santoprene® Duro 70 Unit Pkg. 50'</p>	 <p><b>C-37W</b> Black Santoprene® Duro 70 Unit Pkg. 50'</p>	 <p><b>B-900W</b> Black - EPDM Duro 80 Unit Pkg. 75'</p> <p><b>825-012</b> Chrome - Vinyl Duro 80 PKG QTY. 200'</p>
---	---	--	--

**Helpful Hint:** Brush liquid soap into wedge recess before installing wedge section.

K

K4

Inch

**Two Piece Weatherstrips / Extruded Shapes**

Pouce

Bourrelets d'étanchéité deux pièces / Formes extrudées

**TWO PIECE SELF-SEALING WEATHERSTRIPS**

Continued from Previous Page

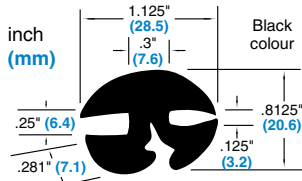

Compound: SBR 70 Duro  
**825-B23-1X** Weatherstrip Channel only  
 Compound: Santoprene 55-60 Duro  
**825-B24-1A** Weatherstrip Channel only  
**PKG QTY. 150 FT.**

Locking Strip  
**B-900W**

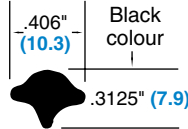

Compound: EPDM 80 Duro  
**B-900W**  
 Wedge Only  
**PKG QTY. 75 FT.**

**"WEDGE-TITE"**  
 COMPLETE PACKAGE  
 Two-Piece Weatherstrip  
**825-282A**

Pkg. contains:  
 825-B24-1A and B-900W  
 Black Santoprene 55-60  
 Duro Channel + EPDM Wedge  
**PKG QTY. 150 FT.**  
 (Helpful Hint: Brush liquid soap into wedge recess before installing wedge section).

**Material:**

EPDM, Santoprene®, SBR, Neoprene, PVC, Vinyl, Silicon, etc., as indicated.  
 (Please refer to "Elastomer Compound Characteristics" - page R19.)

**Hardness:**

Durometer shown under profile and No., subject to ±5.

 <b>825-B25-1P</b> Santoprene® Duro 60 PKG QTY. 10 Lengths (11' - 6")	 <b>825-B40-1Y</b> SBR Duro 55 PKG QTY. 5 Lengths (10')	 <b>825-223</b> Neoprene Duro 50 PKG QTY. 50 FT.	 <b>RW-100</b> SBR Duro 70 PKG QTY. 75 FT.	 <b>825-226</b> Neoprene Duro 50 PKG QTY. 50 FT.	 <b>825-043</b> Neoprene Duro 60 PKG QTY. 50 FT.	 <b>825-B03-1C</b> EPDM Duro 70 PKG QTY. 50 FT.
--	--	--	--	--	--	---

 <b>825-219</b> SBR Duro 60 PKG QTY. 50 FT.	 <b>RW-23</b> SBR Duro 65 PKG QTY. 4 Lengths (11' - 6")	 <b>4581</b> SBR PKG QTY. 50 FT.	 <b>825-B27-1C</b> Santoprene® Duro 65 PKG QTY. 4 Lengths (11' - 6")	 <b>825-234</b> Grey Silicon Duro 40 PKG QTY. 60 FT.	 <b>825-044</b> EPDM Duro 70 PKG QTY. 50 FT.
---	--	---	---	--	--

**825-305** Vinyl Duro 65  
 PKG QTY. 150 FT.

**RW-136**  
 Vinyl Duro 75  
 PKG QTY. 100 FT.

**SPAENAUR**

No.	W	H
4530	1/4"	3/4"
4531	1/4"	1"

**"T" Shapes**  
 SBR Duro 65  
 PKG QTY. 50 FT.

**4625**  
 SBR Duro 70  
 PKG QTY.  
 5 Lengths (10')

**825-B41-1C**  
 PVC Duro 65  
 PKG QTY. 100 FT.  
 Continued on next page











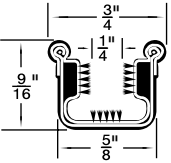

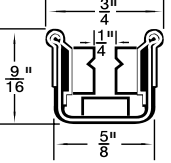
**Channels / Trim Seals**

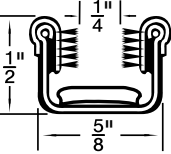
Inch

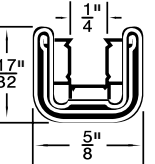
**Garnitures d'étanchéité / Profils / Joints d'étanchéité**

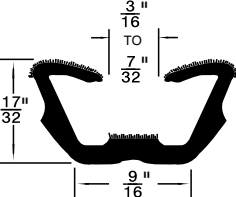
Pouce

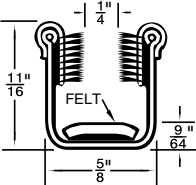
<b>CHANNEL</b>		
 <p><b>4908</b> Wool pile lined sides, felt bottom. Aluminum Beads (Bright). Rubber covered. Flexible steel core with solid bottom for extra sharp bending. <b>HIGHEST QUALITY</b> General Purpose.</p>  <p>PKG QTY. 4 LENGTHS (96")</p>	 <p><b>4908A</b> Wool felt lined, sides and bottom. Stainless steel beads (Bright). Black Fabric Back. Flexible steel core with solid bottom for extra sharp bending. <b>STANDARD QUALITY</b> General purpose.</p>  <p>PKG QTY. 4 LENGTHS (96")</p>	 <p><b>4910A</b> Wool pile lined sides, felt bottom. Beadless. Rubber covered. Flexible steel core - perforated. <b>HIGHEST QUALITY</b> General Purpose.</p>  <p>PKG QTY. 4 LENGTHS (96")</p>
 <p><b>825-B17-1T</b> Wool felt lined, sides and bottom. Beadless. Cloth covered. Flexible steel core. A universal type.</p>  <p>PKG QTY. 1 LENGTH (96")</p>	 <p><b>LC-17</b> All rubber channel with flock-coated lining.</p>  <p>PKG QTY. 4 LENGTHS (96")</p>	 <p><b>RW-63</b> Flexible unbeaded rubber covered channel wool pile fabric lining, felt bottom. Used wherever extra high leg (1 1/16") and pile side lining are desired.</p>  <p>PKG QTY. 4 LENGTHS (96")</p>

**SNAP-ON WEATHERSEAL**

**FLEXIBLE PLASTIC** (Flexible Metal Core) (also available with an Aluminum core – contact our order desk for more information)

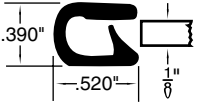
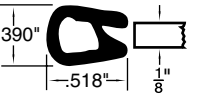
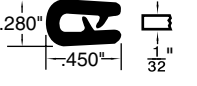
	<b>SPAENAUR No.</b>	<b>Colour</b>	<b>Panel Thickness</b>	<b>PKG QTY.</b>	 <p><b>"Q" TRIM for 1/4" Edges</b> Grips edges from .135" to .250" thick. <b>825-B35-1X</b> Black <b>825-313</b> White (With Flexible Metal or Aluminum core.) <b>PKG QTY. 250 FEET</b></p>
 <p><b>STANDARD SINGLE LIP TRIM</b> Basketweave</p>	<b>RW-85</b>	White	.032" to .125"	400'	
	<b>RW-85B</b>	Black	.032" to .125"	400'	
 <p><b>PINCH TOP SINGLE LIP TRIM</b> Sof-Tone</p>	<b>825-B11-1X</b>	Black	.060" to .170"	400'	
	<b>825-049</b>	Black	.060" to .170"	20'	
	<b>825-050</b>	White	.060" to .170"	20'	
	<b>825-091</b>	Black	.085" to .210"	300'	
 <p><b>MINITRIMS DOUBLE LIP TRIM</b> Sof-Tone</p>	<b>825-509</b>	Black	.010" to .050"	250'	

**K12**



© 2018 Spenaaur Inc. All rights reserved. Catalog may not be reproduced, in whole or in part, without the written permission of Spenaaur Inc. Subject to Catalog Terms and Conditions of Use available at Spenaaur.com and on page TC2 and TC3 at the back of this catalog.  
© 2018 Spenaaur Inc. Tous droits réservés. Le catalogue ne peut être reproduit, en tout ou en partie, sans l'autorisation écrite de Spenaaur Inc. L'utilisation est soumise aux Conditions d'utilisation du Catalogue disponibles sur Spenaaur.com et à la page TC4 et TC5 à la fin de ce catalogue.

Inch

# Flexible Weatherstrips / Rubber Channel Tools

Pouce

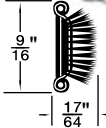
Bourealets d'étanchéité flexibles / Outils pour profilés en caoutchouc

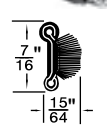
 <p><b>Spaenaur No. C-9</b> CONTOUR WEATHERSTRIPS WITH STAINLESS STEEL BEAD</p> <p>Flexible steel core. Rubber covered. Wool pile fabric. Used on many cars and trucks since 1945, especially on hardtops.</p> <p>Top bead is stainless steel. Bottom bead is galvanized steel.</p> <p><b>PKG QTY. 6 Lengths (96")</b></p> 	 <p><b>Spaenaur No. 4912</b> CONTOUR WEATHERSTRIPS WITH STAINLESS STEEL BEAD</p> <p>Flexible steel core. Rubber covered. Wool pile fabric. Used on many cars and trucks since 1945, especially on hardtops.</p> <p>Top bead is stainless steel. Bottom bead is black plated.</p> <p><b>PKG QTY. 6 Lengths (96")</b></p> 
---	---



**Spaenaur No. C-54** CONTOUR WEATHERSTRIPS

Flexible steel core. Rubber covered. Wool pile fabric. Top edge is beadless. Bottom edge has black bead. Used as belt and contour weatherstrips on many cars since 1935.

**PKG QTY. 6 Lengths (96")**





**Spaenaur No. C-55** 96" long CONTOUR WEATHERSTRIPS FLEXIBLE DRAFT STRIP

For automotive, industrial, construction and household usage. Forms draft-proof cushion between glass and lower garnish moulding.

Wool pile fabric. Rubber covered. Flexible steel core. Beadless.

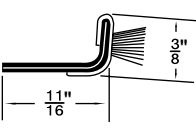
**PKG QTY. 6 Lengths (96")**





For use in: Cabs, combines, earth moving equipment, trucks, bus windows, boat windows, delivery trucks, curved windows, recreational windows and sashless windows. ● Flexible in all directions ● Economical and easy to use ● Installs easily ● Guaranteed long life ● Replaces rigid channels ● Rot, mildew and corrosion resistant.

**Flexible Channel**

Flexible Steel Core  
Woven Black Pile Lining  
Black Cloth Covering

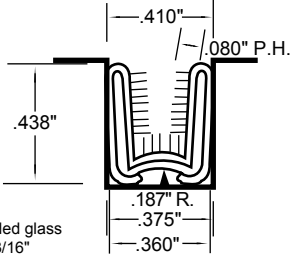
**Spaenaur No.**  
825-314 **PKG QTY. 500 Feet**  
825-347 **PKG QTY. 100 Feet**



PH = Pile Height  
R = Recess  
Recommended glass size is 3/16"

## E-Z Lock Tools

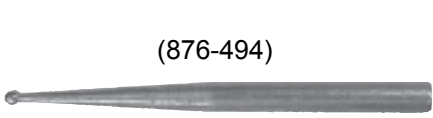

(876-494)

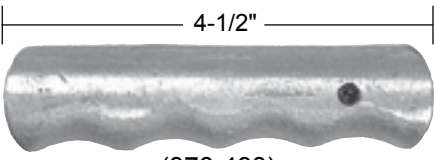

(876-493)

4-1/2"

**PKG QTY. 1**

FOR INTEGRAL LOCK, ONE PIECE SELF-SEALING WEATHERSTRIPS



**Spaenaur No.**  
876-493 Aluminum Handle  
876-494 Straight Bit  
876-591 Cornering Bit (Right Hand)

Please Note: Above items are NOT sold as a unit, but must be ordered separately.



**Spaenaur No. 876-496**

Nylon Spatula for glass insertion into rubber channel, tucking in cut ends, etc.

8" Overall Length.

**TOOL PULLS THE LOCKING STRIP INTO THE RETAINER CHANNEL**

CATALOG 14 SPAENAUR

Inch

# Weatherstrip & Sponge Cord

Pouce

Boureaux d'étanchéité et cordon mousse

**WEATHERSTRIP EXTRUSIONS** — of Closed Cell **NEOPRENE** Sponge  
Heat and Cold resistance — **Minus 45°C to Plus 150°C** (-40°F to +225°F)

**Colour, Black**  
unless shown otherwise

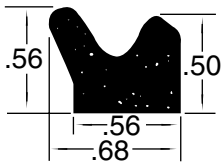

**SPAENAUR No 825-319**  
Neoprene

**SUN ROOF SEAL**  
(Black)

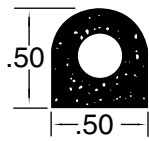

**SPAENAUR No 825-B21-1W**  
Neoprene



**SPAENAUR No 825-353**  
Neoprene

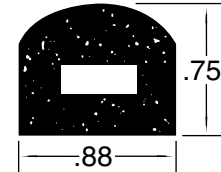

**SPAENAUR No 825-321**  
Neoprene

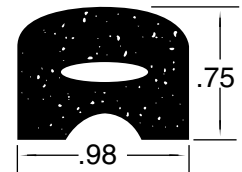

**SPAENAUR No 825-322**  
Neoprene

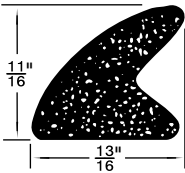

**SPAENAUR No RW-2**  
(For Ford Cars)

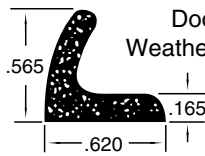

**SPAENAUR No 825-057**  
(For Chrysler Cars)

PKG QTY. 50 FT.

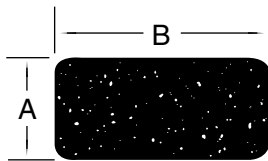

**RECTANGLE**

SPAENAUR No.	A	B
825-338	.25"	.50"
825-340	.38"	.75"
825-344	.50"	.75"
Neoprene		

PKG QTY. 50 FT.

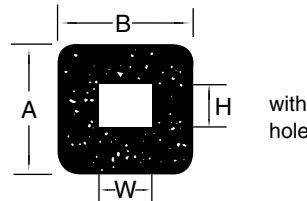

**RECTANGLE & SQUARE**

SPAENAUR No.	A	B	W	H
825-330	.50"	1.00"	.685"	.025"
825-331	.75"	.75"	.685"	.025"
Neoprene				

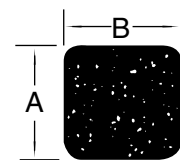

**SQUARE**

SPAENAUR No.	A	B
825-326	.38"	.38"
825-327	.50"	.50"
825-328	.62"	.62"
Neoprene		

**HALF ROUNDS**

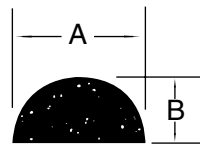

SPAENAUR No.	A	B
825-059	.25"	.12"
825-060	.38"	.19"
825-061	.50"	.25"
Neoprene		

## ROUND SPONGE CORD

Closed Cell Neoprene

SPAENAUR No.	CORD DIA.	PKG QTY.
4658	3/4" Dia.	50 FT.

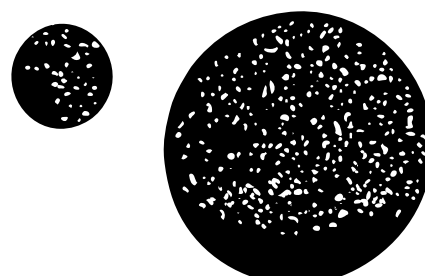

(See page K6 for Solid Neoprene Cord)

**Adhesive Foam & Sponge Tape**

Ruban mousse et isolant adhésif

**STICKER-TITE**

Inch  
Pouce



**EASY AND SIMPLE TO APPLY**

This wonder strip is always ready to be applied to any clean surface by simply removing the liner tape which protects the adhesive surface.

Comes with Skived Finish.



**PEEL and STICK**

Pressure-sensitive adhesive on one side.

**SBR OPEN CELL SPONGE**

Medium density - Low deflection  
2 to 5 lbs. per square inch.

SPAENAUR No.	Thickness	Width	PKG QTY.
360	5/32"	3/8"	200 Feet
377		1/2"	150 Feet
378		5/8"	100 Feet
361	5/32"	3/4"	100 Feet
892-W03-1K		1"	100 Feet
373		1-3/4"	50 Feet
892-021	1/4"	3/8"	100 Feet
363	5/16"	3/8"	100 Feet
364		1/2"	75 Feet
365		5/8"	50 Feet
366		3/4"	50 Feet
367		1"	50 Feet
379	5/16"	1-1/2"	25 Feet
375		2"	25 Feet
368	7/16"	3/8"	100 Feet
369		1/2"	75 Feet
370		3/4"	50 Feet
371		1"	50 Feet
376	7/16"	2"	25 Feet

**NEOPRENE/EPT/SBR BLEND**

CLOSED CELL SPONGE Medium density

SPAENAUR No.	Thickness	Width	PKG QTY.
892-W12-1A	1/8"	3/8"	50 Feet
892-360		1/2"	50 Feet
892-W06-1K		3/4"	50 Feet
892-362	3/16"	3/8"	50 Feet
892-363		3/4"	50 Feet
892-W11-1X		1"	50 Feet
892-W09-2X	1/4"	1/4"	100 Feet
892-365		3/8"	25 Feet
892-366		1/2"	25 Feet
892-W04-1W		3/4"	25 Feet
892-367	5/16"	1"	25 Feet
892-368		3/8"	25 Feet
892-369		1/2"	25 Feet
892-380		9/16"	25 Feet
892-370		3/4"	25 Feet
892-371	3/8"	1"	25 Feet
892-372		1/2"	25 Feet
892-373		3/4"	25 Feet
892-377	7/16"	1"	25 Feet
892-W07-1W		1/2"	25 Feet
892-381		3/4"	25 Feet
892-376	1/2"	1"	25 Feet
892-384		3/4"	25 Feet

**Polyester URETHANE Foam Sponge**  
Pressure-sensitive adhesive on one side

OPEN CELL — BLACK COLOUR  
SOFT AND RESILIENT

Used as cushioning, and as draft, dust or light seal.

SPAENAUR No.	Thickness	Width	PKG QTY.
892-W13-1P	1/4"	1/4"	40 Feet
•892-394		3/8"	40 Feet
892-W01-2P	1/2"	3/4"	50 Feet

• Colour: Grey

**NEOPRENE and NEOPRENE/EPDM EXTRUDED CLOSED CELL SPONGE**

Ideal for applications requiring a lightweight seal with insulation and cushioning.

**Advantages:**

- Clean, smooth skin for a tight seal.
- Low water absorbtion.
- Resistance to structural collapse.
- Excellent insulator with good temperature range (-45 °C to +150°C).
- Ability to conform to curves, corners, varying cross sections, and irregular surfaces.

**A Quality Engineered Product.**



Inch

**Adhesive Foam & Sponge Tape**

Pouce

**Ruban mousse et isolant adhésif**

# “EASY-OPEN”

GREY COLOUR (8 lb. density)

Closed Cell – P.V.C. (Polyvinyl Chloride)

## FOAM TAPE SEALANT

With Non-Clinging Top Surface

Pressure-sensitive, with aggressive adhesive coating on one side.

Flame retardant and fungus resistant.

Mar-resistant, smooth, non-clinging top surface.

For exterior or interior closures which are subject to PERIODIC OPENING AND CLOSING, such as instrument panels and switch-gear, commercial and residential doors.

SPAENAUR No.	Thickness	Width	PKG QTY.
892-W08-1M	<b>1/8"</b> (3.2 mm)	1/4"	100 FEET
892-476		3/8"	100 FEET
892-477		1/2"	100 FEET
892-W33-1W		3/4"	100 FEET
892-479	<b>1/4"</b> (6.4 mm)	3/8"	50 FEET
892-480		1/2"	50 FEET
892-481		19/32"	50 FEET
892-482		3/4"	50 FEET
892-483	<b>3/8"</b> (9.6 mm)	1/2"	30 FEET
892-484		3/4"	30 FEET
892-485		1"	30 FEET

Performance Data & Properties (Typical Data for 6.4 mm material)		Load at 50% Compression:	5 lbs./sq.in.	Resistance To:	
Density:	8 lbs./cu. ft.	Test Method	ASTM D-1667	Weather	Excellent
Test Method	ASTM D-1667	Compression Set:	8%	Fungi	Excellent
Ultimate Tensile Strength:	9 lbs./in. width	Test Method	ASTM D-1667	Combustion	Excellent
Test Method	PSTC-31	Flammability:	Self-extinguishing	Oxidation	Excellent
Elongation:	100 % min.	Test Method	ASTM D-1692	Salt Water	Good
Test Method	PSTC-31	Service Temperature:	Intermittently up to	Weak Acids	Good
Peel Adhesion: @90°	1.5 lbs./in. width	Min. -29°C	+71°C	Weak Bases	Good
Test Method	PSTC 1A	(-20°F	+ 160°F	Solvents	Poor
			93°C	Petrol	Fair
			200°F)	Lacquer Mar	Excellent
For “SEAL-KING” Foam Tape Sealant, see page K18.		Recommended Application Temperature:	<b>18°C to 52°C</b> (65°F to 125°F)		

 CATALOG 14  
SPAENAUR

**Adhesive Foam & Sponge Tape**

Inch

Ruban mousse et isolant adhésif

Pouce

**“SEAL-KING”** P.V.C. (Polyvinyl Chloride)  
**FOAM TAPE SEALANT**



**CLOSED CELL - GENERAL PURPOSE**

This is a low density, very aggressive adhesive foam sealant, used extensively in the automotive and other industries for permanently sealing against air, water, dust, vibration and noise.

**ADHESIVE**

(Acrylic Type)

Pressure Sensitive

**ON ONE SIDE**

**BLACK colour only.**

SPAENAUR No.	Thickness	Width	PKG QTY.
892-W10-1M	<b>1/8"</b> (3.2 mm)	3/8"	100 feet
892-W05-1M		1/2"	100 feet
892-W02-1Y		3/4"	100 feet
892-453		1"	100 feet
892-454	<b>3/16"</b> (4.8 mm)	1/2"	50 feet
892-W16-1N	<b>1/4"</b> (6.4 mm)	1/2"	50 feet
892-457		3/4"	50 feet
892-458		1"	50 feet
892-459	<b>3/8"</b> (9.6 mm)	3/4"	25 feet
892-460		1"	25 feet
892-461	<b>1/2"</b> (12.7 mm)	3/4"	25 feet

**Performance Data and Properties**

**Density:** 6.75 ± 1.0 lb./ft<sup>3</sup>  
Test Method ASTM-D-1667

**Tensile Strength:** 2.0 lbs./in. width min.  
Test Method PSTC-31 STP-7

**Service Temperature:**  
Min. **-29°C** (-20°F) | Max. **+71°C** (+160°F) | Intermittently up to **93°C** (200°F)

**Elongation:** 100% minimum  
Test Method PSTC-31 STP-7

**Recommended Application Temperature:** **16°C to 38°C** (60°F to 100°F)

**Peel Adhesion:** @ 90° stronger than internal strength of foam  
Test Method PSTC-1A STP-6

**Resistance To:**  
Weather: Excellent  
Fungi: Excellent

**Compression/Deflection:** 50% .75 +.5 — .25 psi  
Test Method ASTM-D-1667 STP-10

Combustion: Poor  
Oxidization: Excellent  
Salt Water: Good  
Weak Acids: Good  
Weak Bases: Good  
Solvents: Poor  
Petrol: Fair

**Minimum Compression to Seal at Ambient Temperature:** 30%

**Vinyl Release:** 0.15 lbs./in. width max.  
Test Method STP-2

**Adhesive to Liner Release:** 0.20 lbs./in. width max.  
Test Method STP-2

**NOTE:**

**“SEAL-KING”**

is really a **SEALER** Foam Tape and may cling to the opposite surface if in a fixed position, over a long time.

**“EASY-OPEN”**

(shown on page K17 has a non-clinging top surface.)

K