

SUCTION CUPS - CLEAR or BLACK PVC - 55 Durometer

These suction pads are used in a wide variety of applications from toys and games to posters and sun blinds.

METRIC SIZES

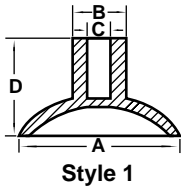

Style 1

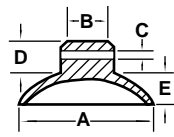

Style 2

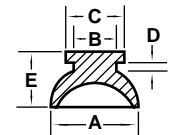

Style 3

SPAENAU No.		Dimensions (mm)					Style	Unit Pkg. Qty.
Clear PVC	Black PVC	A	B	C	D	E		
315-669	315-800	39.7	13.3	-	23.0	-	1	25
315-671	—	38.1	15.9	4.8	19.0	-	1	25
315-673	—	46.0	12.7	6.4	23.8	-	1	25
315-674 (Red)	—	25.4	7.9	6.4	19.0	-	1	50
315-676	315-807	25.4	9.5	7.6	19.0	-	1	50
315-677 (White)	—	38.1	15.9	3.2	9.5	9.5	2	25
315-678	315-809	34.9	12.7	6.4	19.0	9.5	2	50
—	315-810	12.7	6.4	9.5	1.6	9.5	3	100
315-681 (Pale Blue)	—	38.1	11.1	15.9	2.4	17.4	3	25
315-682	315-813	31.8	9.5	12.7	11.1	14.3	3	50
315-684	—	25.4	7.9	1.6	17.5	7.9	5	50
—	315-818	16.0	5.7	5.0	3.0	14.5	8	100

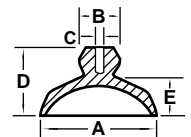

Style 5

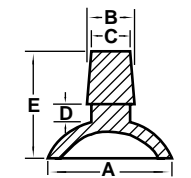

Style 8

Light Type Numbers - Minimum Order 2,500 P.O.R.

INCH SIZES

SUCTION CUPS of 50 Durometer, Isoprene (IR)

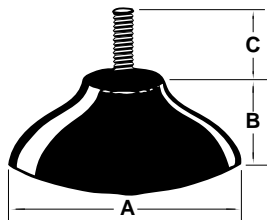

† SBR Material

SPAENAU No.	A O.D.	B Height	C Screw Size	Colour	Unit Package
RB-349	1"	7/16"	8-32 x 1/4"	Black	25
RB-350	1-1/4"	1/2"	8-32 x 1/4"	Black	25
†RB-121	1-3/4"	5/8"	8-32 x 3/8"	Black	10
*315-165	3"	1-7/16"	1/4"-20 x 1/2"	Black	10

*of E.P.T. (Ethylene Propylene Terpolymer) in 55 Duro. Temperature range: -51°C to +177°C (-60°F to +350°F) "Outdoor resistant"

Suction Cup

Tan Isoprene
30 Durometer

315-258

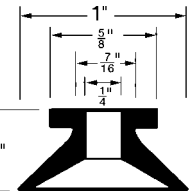

Unit Package 25

INCH SIZES

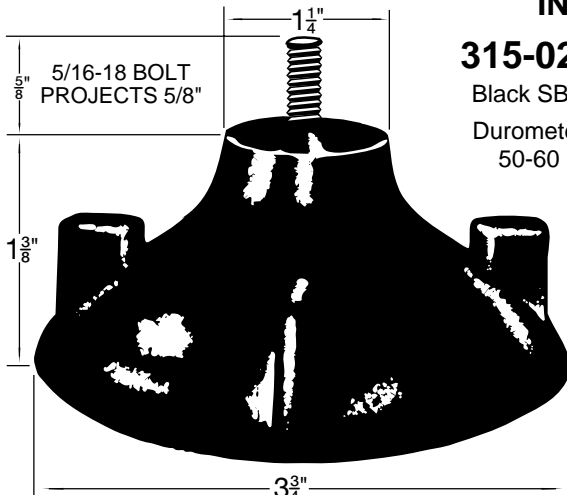

315-029

Black SBR
Durometer 50-60

Unit Package 4

RB-32

Grey SBR
Durometer 50-60

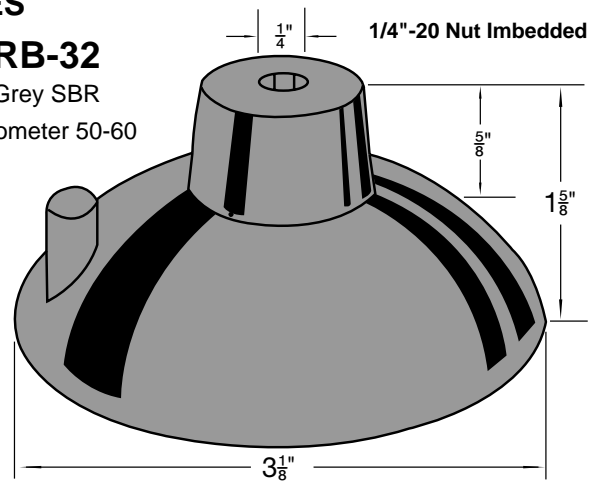

For luggage or car-top carriers, ski racks, boat racks, etc. Non-staining GREY colour.

Unit Package 4